

USERS MANUAL
AUDIO PRECISION SYSTEM ONE

November, 1992

Software Version 2.10

Fifteenth Revision, User's Manual

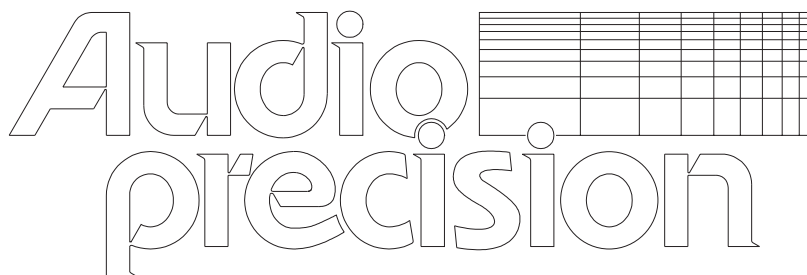

Copyright 1992 by Audio Precision, Inc.
P.O. Box 2209, Beaverton, Oregon 97075 U.S.A.
Telephone (503) 627-0832
U.S. Toll-free Telephone 1-800-231-7350
FAX (503) 641-8906
Telex 283957 AUDIO UR

System One User's Manual, Table of Contents

UNPACK AND INVENTORY	1-1
COMPUTER SYSTEM REQUIREMENTS	2-1
INSTALLING THE INTERFACE CARD	3-1
Card Preparation Before Installation	3-1
PCI-2 Card Preparation	3-1
PCI-1 Card Preparation	3-2
PCI-2 and PCI-1 Interface Card Installation	3-3
Installation, IBM PC	3-3
IBM PS/2 Microchannel Bus Installation	3-4
POWER AND CABLE CONNECTIONS	4-1
Generator-Only and Analyzer-Only Models	4-1
LOADING THE SOFTWARE	5-1
Two Forms of Software	5-1
Hard Disk Operation	5-1
Upgrading From Earlier Versions	5-2
Making Sub-Directories	5-2
DOS PATH Command	5-4
DOS APPEND Command	5-4
Diskette-Based Computers	5-5
DOS	5-5
Diskette Copying	5-5
Bootable Disks	5-5
Starting System One	5-6
Two-Drive Operation	5-6
Single Drive Operation	5-6
Graphic System Compatibility	5-7
Mouse Programs	5-7
More Automated Startup	5-7
GETTING STARTED QUICKLY	6-1
Running Stored Procedures	6-1
Viewing and Running Tests	6-3
Panel	6-3
Making Your First Test Graph	6-3
Graphic Cursors	6-3
Panel Cursors	6-4
Changing Contents of Fields	6-4
Multiple Choice Fields	6-4
Numeric Entry Fields	6-4
Blanked Fields	6-5

QUICK REFERENCES	7-1
Menu System	7-1
Generator Panel	7-3
Analyzer Panel	7-4
Sweep (F9) Definitions Panel	7-5
Software Start-Up Options	7-6
Print-out Options	7-6
Memory Control Options	7-6
Display Related	7-6
Miscellaneous	7-7
Function Keys	7-7
General Information Screens	7-9
Procedures	7-10
UNITS	8-1
Amplitude Units	8-1
Relative vs Absolute Distortion Units	8-4
Relative Frequency Units	8-4
Phase and Polarity Units	8-5
Sine Burst Units	8-6
DSP Units	8-6
GENERATOR PANEL	9-1
Waveform Selection	9-1
Amplitude Control	9-2
Frequency Control	9-3
Output Section Control	9-4
Bal/Unbal/Cmtst	9-6
600/150/50	9-7
Float/Gnd	9-7
Tone Burst Control	9-7
Interactions	9-7
ANALYZER PANEL	10-1
Channel Selection and Principal Voltmeter Function	10-2
Reading Meter Range Control	10-4
Other Measurement Functions	10-4
Filter Frequency Control	10-5
Detector Selection	10-6
Reading Rate	10-6
Bandwidth Control	10-7
Optional Filters	10-7
Input Configuration	10-8
Reference Values	10-8
Range	10-9

SWEEP (F9) DEFINITIONS PANEL	11-1
Stimulus and Horizontal Axis Control	11-1
Source-1 Generator	11-1
Source-1 Analyzer	11-2
Source-1 Switcher	11-2
Source-1 DCX	11-2
Source-1 DSP	11-2
Source-1 External	11-2
Other Source-1 Parameters	11-2
Generator Sweeps and Analyzer Filter Sweeps	11-3
System-Computed Sweeps	11-3
Table-Based Sweeps	11-4
Measurements Versus Time	11-5
Measurement Parameters and Vertical Axis Control	11-6
Graphic and Tabular Display	11-7
Running Tests	11-9
Graphic Cursors	11-9
Re-Plotting to Improve the Graph	11-10
Dual Sensitivity for Same Variable	11-10
Multiple Sweeps	11-10
Repeated Sweeps	11-11
Stereo Mode, Nested Sweeps, and Measurements on the Horizontal Axis	11-11
Stereo Mode	11-12
Generator-Based Stereo Sweeps	11-12
External Stereo Sweeps	11-13
Channel Balance Adjustments	11-15
Plotting Measurements on the Horizontal Axis	11-16
Nested Sweeps	11-16
Overlaying Graphs	11-17
External Sweeps	11-19
SWEEP SETTling	12-1
The Settled Reading Problem	12-1
Sweep Settling Control Panel	12-2
Recommended Values	12-3
Averaging for Noisy Signals	12-3
Timeout	12-4
Settling Delay	12-4
Testing for Delay Through the Device	12-5
Auto and Fixed Sampling Rates	12-6
External Sweeps and Sweep Settling	12-6
MENUS	13-1
Panel, Xdos, Dos, Quit	13-3
Run Menu	13-3
Load Menu	13-5
Save Menu	13-6

Append Menu	13-8
Edit Menu	13-9
General Edit Capability	13-11
Help Menu	13-14
Names Menu	13-14
If Menu	13-17
Util Menu	13-18
Compute Menu	13-20
: (Colon) Line Label Symbol	13-25
BARGRAPH DISPLAY	14-1
Analog Indicators for Adjustments	14-1
Stimulus Control with Bargraphs	14-2
Simultaneous Amplitude and Frequency Control	14-3
Three Parameter Bargraphs	14-3
Bargraphs in Procedures	14-5
Printing Bargraphs	14-5
HARD COPY PRINTOUT	15-1
Introduction	15-1
Pixel-Limited Screen Dump Graphs and Comments	15-3
/F Option	15-3
Graph Size Selection and Printer Compatibility	15-4
Graph Quality vs Size, Printer Mode, and Display System	15-4
Landscape and Portrait Orientation Graphs	15-5
Graphs Without Grids	15-6
Tabular Data Printout	15-6
Panel Printout	15-6
High Resolution Plotter and Laser Printer Output	15-6
Plotter and HP LaserJet Laser Printer Output	15-7
Interactive Mode	15-8
Position Panel	15-8
Attributes Panel	15-10
HP LaserJet Printer Line Attributes	15-12
Saving Configurations	15-12
Making the Plot	15-12
Color Separations	15-13
Define Now, Print Later	15-13
Batch Mode Operation	15-13
Printing Comments to HP LaserJet III	15-15
LaserJet Output via "Laser Plotter"	15-15
PostScript Laser Printer Output	15-16
Position Panel	15-17
Attributes Panel	15-18
Saving Configurations	15-19
Making the Printout	15-19

Color Separations	15-19
Saving to Disk	15-20
Desktop Publishing	15-20
Batch Mode Operation	15-20
INTERMODULATION DISTORTION	16-1
Theory of Operation	16-1
Setting Up the Generator Panel	16-2
Setting Up the Analyzer Panel	16-2
Bandpass Filter Use During IMD Testing	16-3
Intermodulation Distortion Sweep Testing	16-4
Amplitude Measurements of IMD Signals	16-4
WOW AND FLUTTER	17-1
Theory of Operation	17-1
Measurement Standards	17-1
Scrape Flutter	17-1
Making Wow and Flutter Measurements	17-2
Spectrum Analysis of Wow & Flutter	17-3
Standards and Test Methods	17-4
Display Types	17-5
SWITCHER MODULES	18-1
Introduction	18-1
Functional Description	18-1
Input Switcher	18-1
Output Switcher	18-1
Patch Point Switcher	18-2
Terminal Strip Switcher	18-5
Jumper Selection	18-5
Input/Output Connections	18-5
Installation	18-6
Control of Switchers	18-8
Switcher Control Panel	18-8
Driving All But One Channel	18-8
Sweep (F9) Definitions Panel	18-9
Nested Switcher Scans	18-10
Typical Switcher Applications	18-11
Stereo Control Preamplifier	18-11
Multi-track Tape Recorder	18-12
Audio Chain or Mixing Console Channel	18-16
DIGITAL SIGNAL PROCESSOR	19-1
Typical DSP Applications	19-3
DSP Architecture	19-5
Downloading DSP Programs	19-5
DSP Input Operation	19-6
Rate vs Bandwidth	19-6

Dither	19-7
AES/EBU Status Bytes	19-7
BURST-SQUAREWAVE-NOISE GENERATOR	20-1
Tone Burst Waveforms	20-1
Triggered Bursts	20-3
Gated Sinewaves	20-4
Squarewaves	20-5
Noise Waveforms	20-5
Pseudo and Random Noise	20-5
White Noise	20-5
Pink Noise	20-6
Bandpass Noise	20-6
Equalized Bandpass Noise	20-6
USASI Noise	20-6
DCX-127 DC AND DIGITAL I/O MODULE	21-1
Voltage and Resistance Measurements	21-1
Dc Voltage Measurements	21-2
Resistance Measurements	21-2
Offset and Scaling	21-2
DC Voltage Outputs	21-3
Digital Input	21-3
Digital Output	21-4
Program Control Input	21-5
Program Control Outputs	21-6
Digital Control Output Ports	21-7
REMOTE MODE FOR TRANSMISSION TESTING AND LAPTOP	
COMPUTER OPERATION	22-1
Introduction	22-1
System Architecture, Testing at Two Locations with Two Computers and "A" Version Systems	22-1
System Architecture, Testing at Two Locations with "S" Version System	22-2
System Architecture, Laptop/Notebook Computers	22-3
Master and Slave; General Concepts	22-3
Control Computer Operation	22-4
Remote System Operation	22-4
Laptop Computers with "S" Version Systems	22-5
Transmission Testing with "S" Version System	22-6
Modem Usage with "S" Version System One	22-6
Transmission Testing with Two Computers	22-8
"S" Version System One, General Information	22-9
"S" Version Switch Settings	22-10
"S" Version Technical Details	22-11
DOS Mode Command	22-11
Command Line Options	22-12
Error Messages	22-13

Creating, Running, Viewing, and Editing Remote Test Files 22-13

EQUALIZATION 23-1

Equalization Concepts and Applications 23-1

Using Furnished EQ Files 23-1

Creating Equalization Files from Formulas 23-3

Entering and Editing Equalization Files 23-4

Creating EQ Files from Measured Data 23-4

ACCEPTANCE TEST LIMITS 24-1

Creating A Limit File 24-1

Creating the Test for Use With Limits Files. 24-2

Creating Limits Files By Actual Tests 24-3

Running Tests With Limits 24-3

Master Error Files 24-4

PROCEDURES. 25-1

Loading and Running Procedures 25-1

Generating Procedures 25-2

 Generating Procedures by Learning Keystrokes 25-2

 Learn Mode Procedure Example. 25-2

 Creating or Modifying Procedures in Edit Mode 25-3

Adding to Existing Procedures. 25-4

Program Flow Control 25-5

 Jumping to Another Location: UTIL GOTO. 25-6

 Conditional Branching: IF 25-6

 Conditional Branching Upon Operator Input 25-6

 Sub-Procedures 25-6

 Sub-Procedure Example: Printing Only Upon Error 25-7

 Example: Looping On Error. 25-8

 Sub-Procedure Example: Test Menu 25-8

Changes in Panel Setup During a Procedure 25-9

 Two-Character Codes to Jump to Panel Fields. 25-10

Partial Loads (Overlays) to Protect Panel Fields 25-10

 Creating Overlays. 25-11

 Appearance of Blanked Fields 25-11

Interrupting or Pausing Procedures. 25-12

Prompts, Pauses, and Delays 25-12

De-Bugging Procedures by Single Stepping 25-13

Creating a Form to be Filled In 25-13

Control of External Devices 25-14

Inserting DOS Commands in a Procedure 25-15

Limits, Error Files, and Data Management 25-15

 Storing Data in Subdirectories 25-16

System Startup With Procedure Running 25-17

Continuously-Running Procedures 25-18

Signal-to-Noise Ratio Tests in Procedures 25-18

REGULATION	26-1
Introduction	26-1
Regulation Concept	26-1
Regulation Panel	26-1
Regulation Algorithms	26-2
Success In Regulation	26-4
Setting Up A Regulation Test	26-5
Data Display	26-6
TESTING SPEED	27-1
Time Per Step	27-1
Sweep Time	27-2
Limits and Speed	27-2
Equalization and Speed	27-2
Graphics Save Mode and Speed	27-3
Disk Types and Testing Speed	27-3
Virtual Disks	27-3
Computer Types and Speed	27-4
FASTEST.DSP and Speed	27-4
Software and Speed	27-4
CREATING YOUR CUSTOM SOFTWARE START-UP PROCESS	28-1
Making A Bootable Diskette	28-1
Creating an AUTOEXEC.BAT File	28-1
Testing The Startup Process	28-2
STD.TST File to Set Initial Conditions	28-3
Command Line Options	28-3
Starting With a Specific Test or Procedure	28-4
Starting Up With the Last Test	28-4
Graphics System Compatibility	28-4
Interface Card Locations	28-5
Controlling Memory Usage	28-5
System One Memory Requirements	28-5
Memory Reserved for Programs to Run Under XDOS or DOS Exit	28-6
Screen Display Memory	28-6
Internal Buffers of S1.EXE	28-7
Data Point Buffer	28-7
Limit/Sweep/EQ File Buffer	28-7
Edit Data Buffer	28-7
Edit Procedure Buffer	28-7
Edit Comment Buffer	28-7
Edit Macro Buffer	28-8
Buffer Size Control	28-8
Buffer Swap to Disk	28-9
Screen Appearance of Punched-Out Fields	28-9
Printer Mode and Printed Graph Size Selection	28-9

Formatting of Graph Printout	28-10
Plotter and Laser Printer Compatibility	28-10
Command Line Query	28-10
Batch Files for Loading S1.EXE	28-10
Using the Environment to Control Start-Up	28-11
MOUSE OPERATION	29-1
Introduction	29-1
Mouse Compatibility, PCI-1 Card	29-1
Mouse Compatibility, PCI-2 Card	29-1
PCI-2 Installation with Bus Mouse	29-1
PCI-2 Installation with Serial Mouse	29-1
PCI-3 Installation with Mouse	29-2
Mouse Software Installation	29-2
Mouse Usage	29-2
COMPUTER MONITOR NOISE FIELDS	30-1
AUDIO TESTING	31-1
Introduction	31-1
Amplitude or Level Measurements	31-1
Frequency Response	31-1
Frequency Response at Constant Output Amplitude	31-2
Testing Pre-Emphasized Transmitters	31-3
Frequency Response of Compact Disc Players	31-3
Frequency Response of Tape Recorders and Players	31-4
Three Head Machines	31-4
Determining Tape Recorder Delay	31-4
Two Head Machines	31-5
Recording a Test Tape	31-5
Playback Frequency Response	31-5
Gain and Loss	31-6
Signal to Noise Ratio	31-6
Absolute Noise Tests	31-7
Non-Linearity Tests	31-7
Harmonic Distortion Concepts	31-7
SMPTE/DIN Intermodulation Concepts	31-7
CCIF Intermodulation Concepts	31-8
DIM/TIM Intermodulation Concepts	31-8
Distortion Versus Amplitude	31-8
Distortion Versus Frequency	31-8
Distortion at Constant Power Tests	31-9
Tape Recorder Non-Linearity	31-9
Distortion Versus Frequency of Tape Recorders	31-9
Compact Disc Player Non-Linearity	31-10
CD Player THD+N Versus Frequency	31-10
Quantization Distortion	31-10
Phase Measurements	31-12

Input-Output Phase Measurements	31-12
Interchannel Phase Measurements	31-12
Tape Recorder Azimuth Adjustments	31-13
ANALYZER AND GENERATOR HARDWARE	32-1
Analyzer Block Diagram	32-1
Generator Block Diagram	32-4
Intermodulation Test Signal Generation Hardware	32-4
BUR Option Hardware	32-4
Auxiliary Generator Connectors	32-5
S1.EXE ERROR REPORTING DESCRIPTIONS	33-1
FURNISHED DISK FILE DESCRIPTIONS	34-1
S1.EXE version: 2.10 Diskette	34-1
Test and Procedures Diskette	34-1
Utilities and Equalization Diskette	34-6
INDEX	35-1

1. UNPACK AND INVENTORY

Your new System One comes packed in a carton which also contains the interface card, cable, software, and documentation. Check to be sure that you have received:

- a. System One enclosure with all modules and options which you ordered installed (check the packing list for specific options)
- b. PCI plug-in interface card for installation in computer (unless you ordered the "S" or "G" versions of System One)
- c. cable with 25-pin connectors to connect System One to computer interface card (unless you ordered the "S" or "G" versions of System One)
- d. ac power line cord
- e. two training videotapes in the appropriate video standard for your area. The basic operator's training videotape is APV-1 and the advanced training videotape is APV-2
- f. this User's Manual, with diskettes containing System One software

If your order also included the DCX-127 module or SWR-122 family of switchers, each of these modules will be shipped in a separate carton with a 0.5 meter digital interface cable and an ac power line cord.

It is recommended that you save the carton(s) in case it is ever necessary to ship System One.

2. COMPUTER SYSTEM REQUIREMENTS

System One requires an IBM PC or fully compatible computer in order to operate. System One has been successfully operated with computers using 8088, 8086, 80286, 80386, and 80486 microprocessors. With well over 2,000 units of System One in operation, there have been no reports of incompatibility between System One and any PC-compatible computer with either the original PC bus or the Microchannel bus. The PCI-3 interface card is required for Microchannel bus computers.

The computer must have a minimum of 640 kb of memory. It must be operating with DOS (disk operating system) Version 2.2 or later. It must contain a color graphics card (CGA), enhanced graphics card (EGA), video graphics array card (VGA), Toshiba 3100 display system, or a Hercules^(TM) monochrome graphics card or equivalent, driving a monochrome or color monitor which is compatible with the graphics card.

A minimum of one diskette drive is required. Two diskette drives or one diskette drive and one hard disk drive are recommended for the most convenient operation. The hard disk, or configuring part of the computer memory as virtual disk (ram disk) is particularly recommended for applications where procedures will be used (see PROCEDURES chapter) or where data or error file information from tests will be saved. It is strongly recommended that a math co-processor be installed (8087 for 8088 and 8086-based computers; 80287 for 80286-based computers). System One will operate without it, but operating speed is greatly enhanced by the co-processor.

IBM PC and Microchannel are trademarks of the IBM Corporation.

Hercules is a trademark of Hercules Computer Technology, Inc.



3. INSTALLING THE INTERFACE CARD

An interface card must be installed in the computer for operation of the original and “A” versions of System One. Neither the “S” (serial, or RS-232) version nor the “G” (GPIB) version requires an interface card. See the special operator’s manual supplement furnished with “S” version systems for information on preparation of the computer.

Audio Precision has manufactured three versions of interface card. All contain a 25-pin female connector for the digital interface cable to System One. The PCI-1 card (no longer in production) contains a second connector, a 9-pin female subminiature D type connector for connection to an original version Microsoft bus (parallel) mouse. The PCI-1 card is compatible only with this original version bus mouse; it is not compatible with the later version bus mouse which has a round DIN style connector.

The PCI-2 interface card contains a 9-pin male subminiature D type connector for use as a serial port. The PCI-2 card is compatible with either a se-

rial mouse, or a parallel mouse with its own interface card. The bottom edge of either the PCI-1 or PCI-2 card consists of gold-plated contacts to plug into the computer “mother board”.

The PCI-3 card is designed for the IBM Microchannel bus in the more powerful models of the PS/2 series; it contains neither mouse nor RS-232 port.

3.1. Card Preparation Before Installation

3.1.1. PCI-2 Card Preparation

If the PCI-2 card serial port is not required and a bus mouse will not be installed, the PCI-2 card can be installed without further preparation.

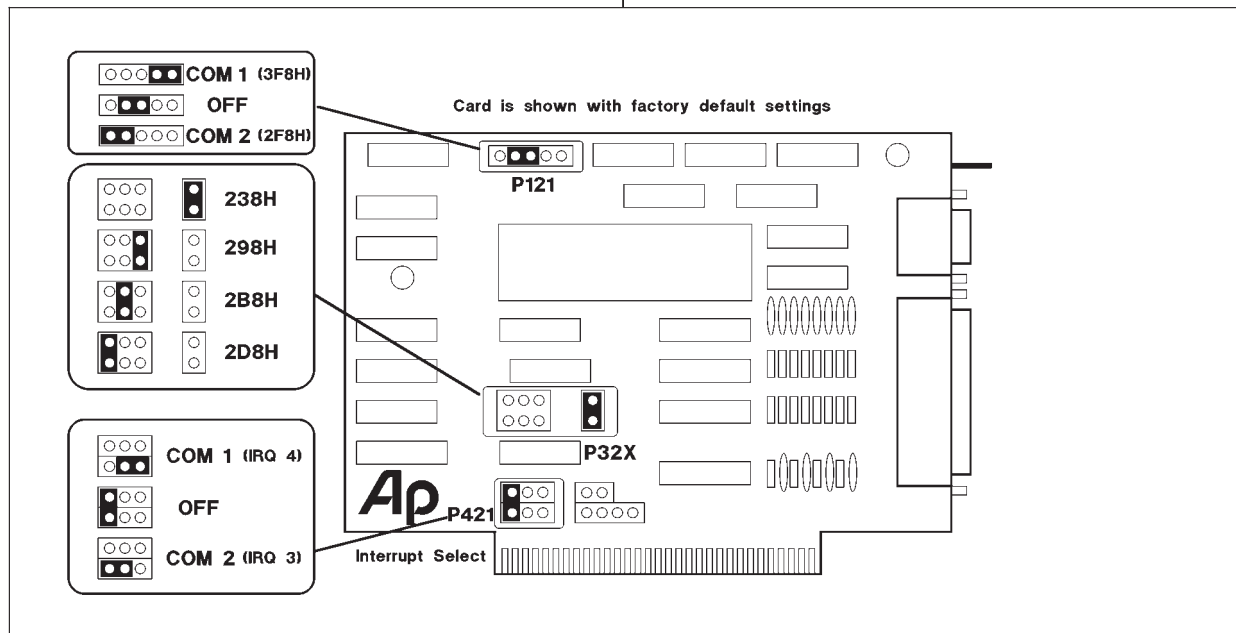

Figure 3-1 Jumper Locations, PCI-2 Card

JUMPER	ADDRESS
P321	238H
P322	298H
P323	2B8H
P324	2D8H

Figure 3-3 PCI-2 I/O Address Jumper Location

If the PCI-2 card is to be installed in the computer along with a bus (parallel) mouse interface card, address conflict may occur. If so, a jumper must be moved on the PCI-2 card to place it at a different I/O address in the computer to avoid conflict with the mouse interface card. Once the jumper is moved, however, only version 1.60 or later software may be used with this card.

The PCI-2 card is shipped with the address set to 238 hexadecimal. All PCI-1 cards were fixed at this same address, and all software versions through 1.50 use this address. Figure 3-3 and Figure 3-1 show the relationship between jumper position on the PCI-2 and the computer I/O address at which System One will be located. Software versions 1.60 and later will automatically determine which address the PCI-2 card is set to and will then communicate with it properly. See page 28-5 for information on forcing the software to work only with a specific address via the /I option at startup.

The PCI-2 card contains a serial port which is not enabled when the card is shipped. This port may be enabled and used for a serial mouse or any other serial port application with System One or other software applications. Note, however, that the IBM-PC and compatible architecture limits the number of serial ports to a maximum of two. If the serial port is to be enabled, jumpers must be moved at the P121 location and the P421 location to configure the port as COM1: or COM2:. Figure 3-2 shows the pins which must be jumpered together at P121 and P421.

MODE	P121	P421
COM2:	pins 4-5	pins 1-2
COM1:	pins 1-2	pins 2-3
OFF	pins 3-4	no jumper

Figure 3-2 PCI-2 Card Serial Port Configuration

Figure 3-1 shows the location of these pins. Note also that the DOS MODE command must then be executed after booting the computer to define communications via this port.

The remaining jumpers which may be noted on the PCI-2 card are related to possible future DMA operation of the interface. They should not be used at this time.

3.1.2. PCI-1 Card Preparation

If an original PCI-1 interface card is being installed or re-installed and you do not have a Microsoft Mouse, be sure the Mouse circuitry is disabled by removing the jumper from positions 2-5. Store the jumper by plugging it onto the top horizontal row of pins (D1 or D3) at the bottom of the PCI-1 interface card, near the gold-plated connector pins. These two pins are already connected together on the foil side of the card.

If the PCI-1 is used with the original version of the bus mouse (9-pin subminiature D connector), the jumper should normally be on position 2 for the IBM-PC, XT, and their "clones", and on position 5 for the IBM-AT and AT "clones". The PCI-1 interface card duplicates the Microsoft Mouse's use of interrupts including the jumper-selectable interrupt number. If the original mouse is used with the PCI-1 card, the interrupt number may be set from 2 to 5. These numbers are etched on the board underneath the four possible jumper pin locations, just below the large integrated circuit, where 2 is the position closest to the cable connectors. In each case, the jumper must connect a center-row pin to the bottom-row pin immediately below it. The XT and most after-market hard disks use interrupt 5, thus making interrupt 2 the correct position for the mouse. The AT uses interrupt 2 internally, making 5 the correct position; however, interrupt 5 may also be associated with a parallel port 2 if present. Interrupt number 3 is normally associated with serial port 2; interrupt number 4 is normally associated with serial port 1.

If the PCI-1 interface card has the jumper installed at the same interrupt location as another device on the computer bus, the result would be malfunction of some portion of the computer system. If you detect an operational problem which was not previously present when you first re-start your computer after installing the interface card, move the jumper.

3.2. PCI-2 and PCI-1 Interface Card Installation

Every different model of computer is likely to have variations in the process necessary to gain access to its mother board sockets for installation of the interface card. This manual contains installation instructions for the IBM PC. Installation in many desktop units is similar to the IBM PC. In all cases, disconnect the power cable and all peripheral equipment cables from the computer before starting.

3.2.1. Installation, IBM PC

Remove the cover mounting screws from the rear of the computer housing (see Figure 3-4), and remove the cover by sliding it off to the front. Locate the expansion card plug-in area at the rear of the computer, near the left end. Select a slot into which you plan to install the System One interface card. In a computer with a mixture of short and full-size slots, you may wish to install the System One card in a short slot. This allows later installation of other accessories which require long slots. The PCI cards are not compatible, however, with slot 8 (the last short slot in PC/XTs) and with the short slot in the Compaq Deskpro.

Remove the screw which holds in place the blank option adapter cover plate (Figure 3-5) immediately behind the selected slot, and retain the screw. Insert the interface card into the slot (Figure 3-6) by aligning its gold-plated contact with the computer motherboard socket and pressing the card firmly down into the socket. Line up the slot in the top edge of the

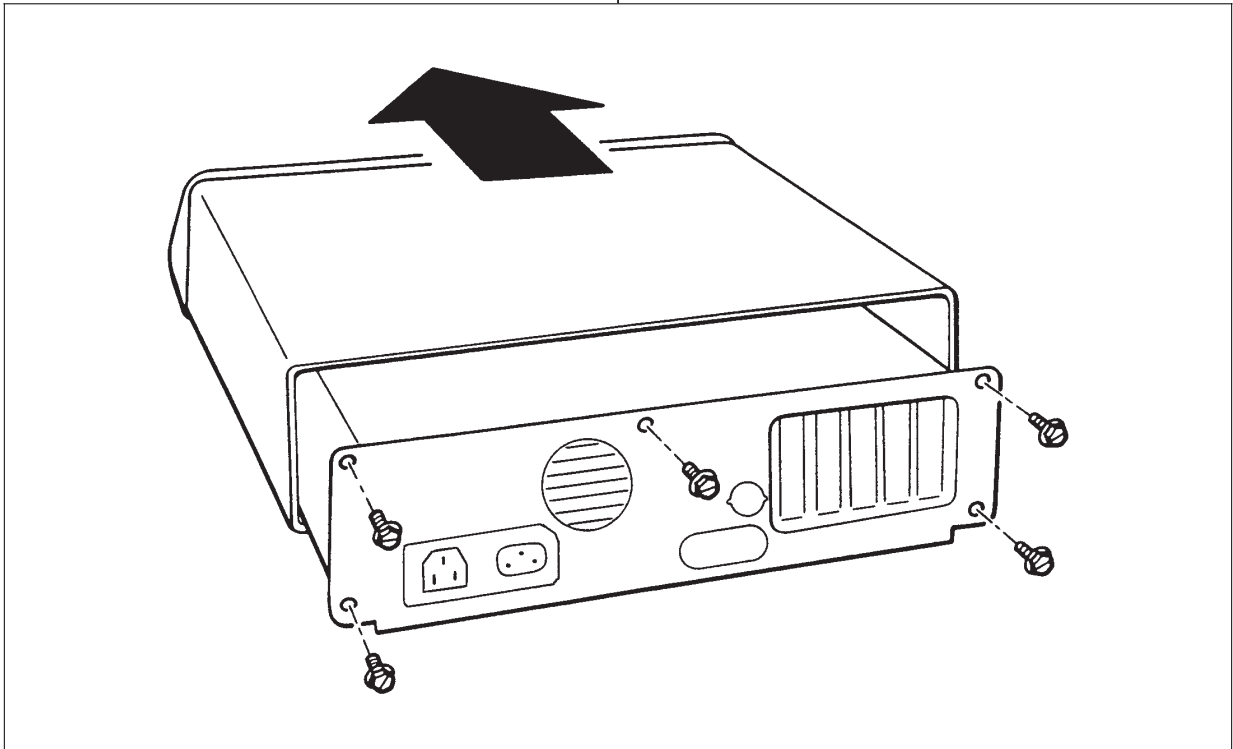

Figure 3-4 IBM PC Cover Removal

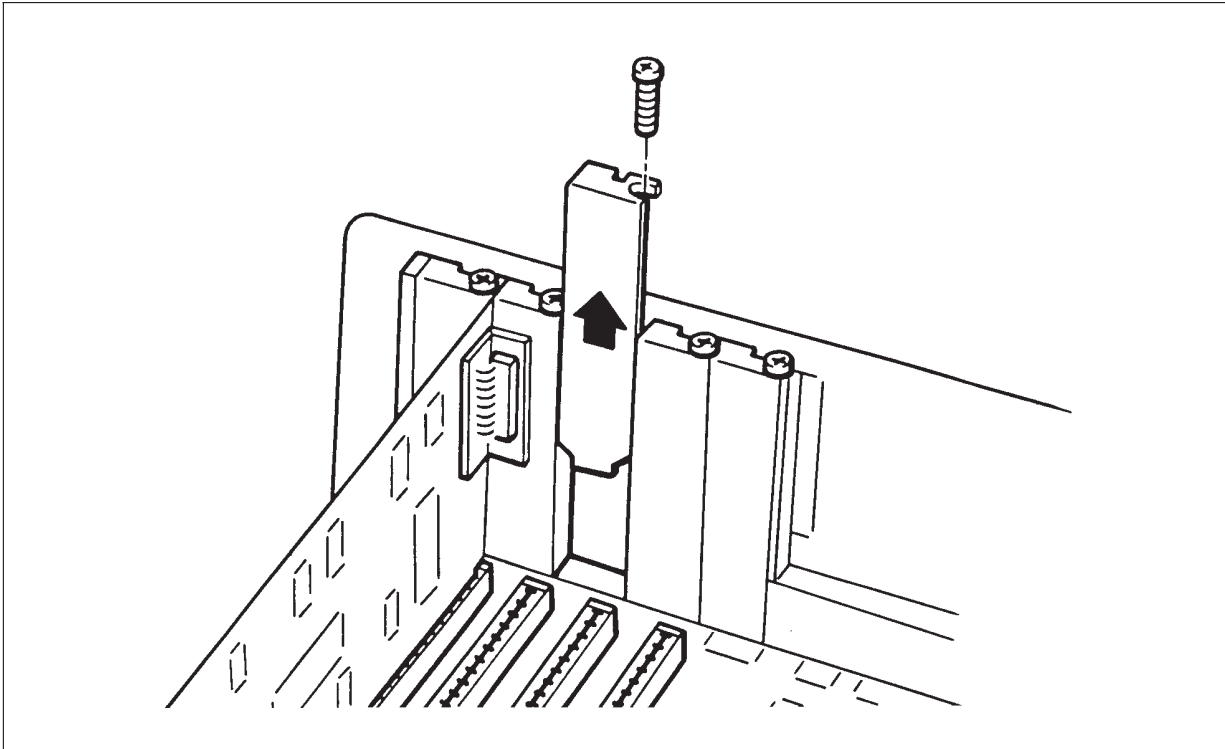

Figure 3-5 Option Adapter Mounting Area

bracket with the screw hole and replace and tighten the screw. Re-install the cover and tighten the screws.

3.3. IBM PS/2 Microchannel Bus Installation

Remove the computer cover and select an empty option slot. Loosen the thumb screws that hold the option cover plate in place and remove the cover plate. Insert the PCI-3 card, making sure that the PCI-3 board is firmly seated in the connector. Tighten thumb screws at the back of the option slot and replace the computer cover.

Put your backup copy of the IBM Reference diskette into drive A: and turn the computer on. The Reference diskette will boot the computer and put an IBM logo on the screen. Press <E> to get to the main menu and select "Copy An Option Diskette" from the menu.

Follow the prompts as they are given. When you are prompted to "Remove the backup copy of the Reference diskette and insert your option diskette in the drive A" insert the System One Software S1.EXE diskette. The file, @6064.ADF, used by the Reference diskette to configure the computer for the System One option, is included on the S1.EXE diskette.

When System One has been installed as an option and the backup Reference diskette updated, you will be prompted to remove the Reference diskette and restart the computer.

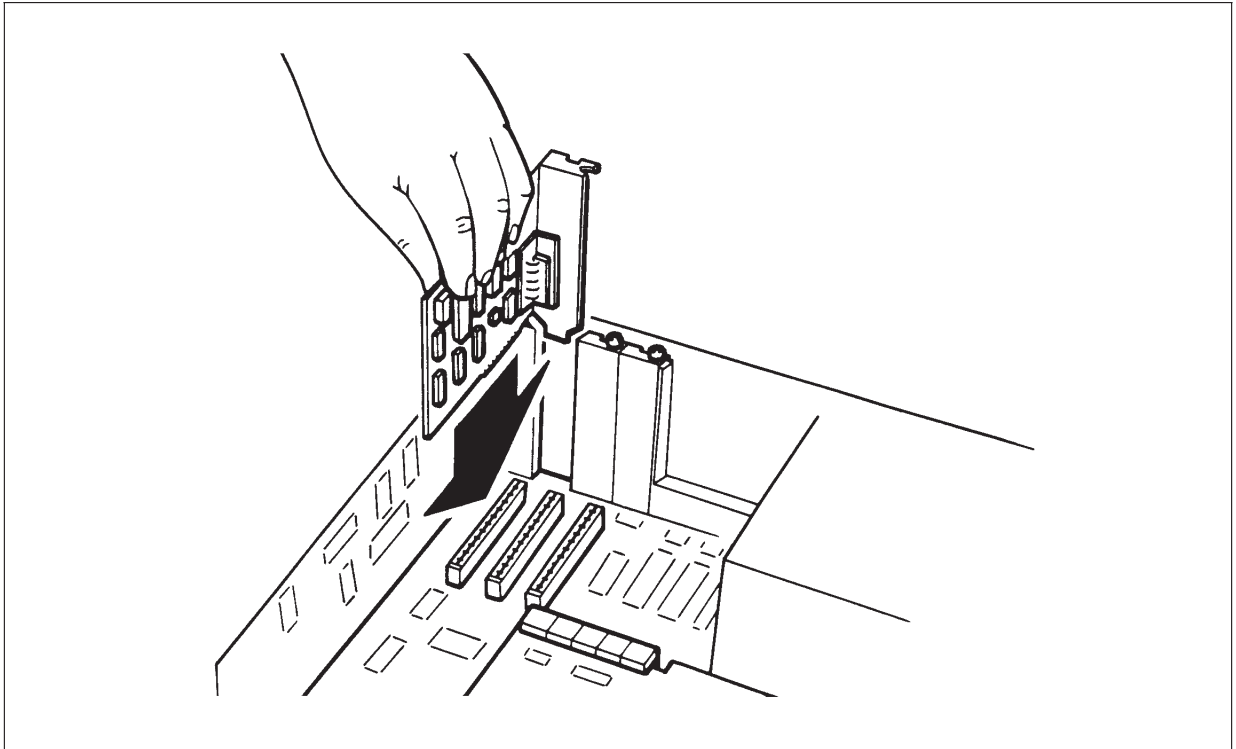

Figure 3-6 Mounting The Interface Card



4. POWER AND CABLE CONNECTIONS

System One and the computer must both be connected to an appropriate ac mains supply. System One and the DCX-127 can operate from 100 volts, 120 volts, 220 volts, or 240 volts ac (+5/-10% in each case), 48-63 Hz ac. The ac mains connector/fuse holder assembly on the chassis rear contains an adapter card which selects the transformer taps for the line voltage. It must be inserted in the correct one of four possible positions, depending on the ac line voltage with which System One will be used. At the same time, a fuse of the proper current rating must be installed. For 100 or 120 volts, System One requires a two ampere fuse must be used; for 220 or 240 volts, System One needs a one ampere fuse. The DCX-127 uses an 0.2 ampere slow blow fuse on all line voltages. After installing the correct fuse, hold the adapter card so that the desired line voltage is upright and readable as you start to insert the card into the connector assembly while facing the System One enclosure from the rear. Slide the card fully into place. Slide the transparent protective cover over the card/fuse area. Connect an appropriate ac mains cable between the connector and the source of power.

System One is designed with a protective ground (earth) connection by way of the grounding connector in the power cord. This is essential for safe operation. Do not attempt to defeat its purpose. For optimum performance, it is recommended that both System One and the computer be connected to the same ac mains circuit to minimize ground loop noise.

The SWR-122 module contains a rear-panel 2-position ac mains voltage range switch. It must be set to the correct range (100-120 V or 220-240 V) for the mains power. Connect the appropriate ac mains cables from the SWR modules to the source of power.

Connect the computer (assuming that it has also been set for the correct voltage) to the ac power source.

Connect the male end of the cable furnished with System One to the interface card installed in the computer. If no DCX-127 or SWR-122 modules will be part of the system, connect the female end of the digital interface cable to the connector on the rear of the System One enclosure. If DCX or SWR modules are present, the long cable from the computer should connect to one of them. Short digital interface cables may then be used to connect additional modules in daisy-chain fashion, with System One the last unit in the chain. This is necessary with earlier models of the "A" version of System One and all "G" or "S" versions when operating in "A" version mode, since they have only one digital interface connector. The DCX and SWR modules and recent "A" version System Ones have both male and female connectors to permit daisy chaining.

4.1. Generator-Only and Analyzer-Only Models

System One can be provided as a generator-only package (SYS-20) and an analyzer-only package (SYS-02). These units are commonly used in testing broadcast transmission links. When the two units are used at the same location, two audio cable connections are required between them so that the generator monitor (GEN-MON) function will work. The generator monitor function permits the analyzer to measure the exact, loaded output voltage from the generator. It is required for self-test procedures such as SYS22CK.PRO (included on the Tests and Utilities diskette) to function. Connect a shielded audio cable with XLR connectors between the Channel A Generator Monitor connectors of the SYS-20 and SYS-02 packages. Connect another shielded cable between the Channel B Generator Monitor connectors on the two units.

Turn on System One, the DCX-127, and the computer. The SWR-122 switchers have no power switch.



5. LOADING THE SOFTWARE

5.1. Two Forms of Software

System One may be software-controlled from an IBM-PC or compatible in two fashions:

- The large majority of System One users find it most efficient and convenient to control the system from the panels and menus provided by the standard software furnished, S1.EXE. S1.EXE provides instant graphic results, analog bar graph indications for adjustments, supports impromptu, unstructured testing, provides structured tests through procedures, supports acceptance test limits for go/no-go testing, and can be operated without prior experience in a programming language. S1.EXE supports virtually all types of audio testing. The balance of this User's Manual (except for the COMPUTER MONITOR NOISE FIELDS chapter and ANALYZER AND GENERATOR HARDWARE chapter) deals exclusively with S1.EXE operation.

System One software is furnished on several diskettes. The principal operating software for System One is contained in a file named S1.EXE. Other diskettes contain a number of example test (.TST) files, procedure (.PRO) files, equalization (.EQ) files, and limit (.LIM) files, performance checks, DSP programs if the unit purchased has DSP capability, plus a number of general utility programs for use during non-audio-testing applications of your computer. Usage of some of the example tests and procedures will be discussed in the next chapter.

- Certain users find it necessary to write their own code. Examples of applications which have required user-written programs include simultaneous control and audio testing of large audio routing switchers, extensive interaction with robots or device handlers, or testing plus significant post processing such as statistical computations. Audio Precision of-

fers for sale two libraries which act as extensions to two common Microsoft programming languages. The LIB-BASIC library is an extension to the Microsoft BASIC Professional Development System v7.10. The Microsoft QuickBASIC Extended Environment is included as part of their Professional Development System v7.10. The LIB-C library is an extension to the Microsoft C language, v5.1 or later. These libraries of call functions allow control of all aspects of System One including the DSP functions, SWR-122 switchers, and DCX-127 hardware from user-written programs in the language specified. Well-written programs in these languages, using these function libraries, typically operate substantially faster than when the same set of tests is performed with the standard S1.EXE software, partially due to the reduction in computer disk accesses.

If the user-written program approach to testing is relevant, contact Audio Precision or your Audio Precision distributor for information on how to purchase the LIB-C or LIB-BASIC library and documentation. LIB-C and LIB-BASIC replace the earlier LIB-MIX, APBASIC library, and "C" language functions. The remainder of this manual will deal with S1.EXE.

5.2. Hard Disk Operation

Most computers in use today have a hard disk (fixed disk) in addition to one or more diskette (floppy disk) drives. This section for software installation assumes that your computer is hard-disk-based, that DOS has been installed and the machine boots from the hard disk, and that proper operation of all portions of the system (monitor, keyboard, etc.) has been verified. If your computer does not have a hard disk, see the "Diskette-Based Computers" section below for instructions.

Audio Precision recommends that a specific set of sub-directories as described below be created on the hard disk for operation of System One, and that specific files from the furnished diskettes be copied into specific hard disk directories.

5.2.1. Upgrading From Earlier Versions

If earlier versions of S1.EXE, test, procedures, etc. have already been installed on your computer and you wish to preserve them for any reason, it is recommended that you copy them into some archive sub-directory or onto diskettes. Then, remove the sub-directories which held the older tests and follow the installation instructions below. After completing the installation of the new software, you may copy back from the archive sub-directories or diskettes any older procedures and tests which you wish to continue using. This process will avoid the risk of a new file in this release over-writing a valuable older file of the same name and thus destroying your unique set-up or data. S1.EXE v2.10 will directly load and use tests from v2.00 and v1.60. If the test is loaded and saved from v2.10, it will save as a v2.10 test. Procedures from earlier versions must have the header changed to PROCEDUREv2.10. No other changes should be required for non-DSP procedures written under v2.00. Procedures from v1.60 or earlier may also require changes if they involved panel cursor movements or if they used certain menu commands which were changed from v1.60 to v2.00.

5.2.2. Making Sub-Directories

To make a new first-level sub-directory on a hard disk (assuming the computer has been booted, type:

```
CD C:\ <Enter> (CD is the DOS command for change directory; this command will place you in the "root", or top level, directory)
```

```
MD dirname <Enter> (MD is the DOS command for make directory; dirname is your desired new subdirectory name such as AUDIO.
```

Audio Precision recommends the name AUDIO for the top-level directory of the group which will hold all distribution software from Audio Precision. Thus, the specific command from DOS after changing to the root is:

```
MD AUDIO <Enter>
```

To then change the current directory from the root directory to this new subdirectory, type:

```
CD AUDIO <Enter>
```

If the DOS PROMPT command has been executed with the proper arguments (typically done in the AUTOEXEC.BAT file), you should see the prompt

```
:\AUDIO
```

You may then copy the entire contents of three of the distribution diskettes into this C:\AUDIO directory. These are the "S1.EXE" diskette, the "Tests & Procedures" diskette, and the "Utilities & Equalization" diskette. To copy a diskette, place it in the A: drive and type

```
COPY A:*. * <Enter>
```

All files from the diskette will then be copied into the current sub-directory, which is C:\AUDIO. For the second and third diskette, it is not necessary to type this command again. The <F3> function key, when in normal DOS command mode, repeats the last-typed DOS command which is then executed by the <Enter> key.

After copying these three diskettes into C:\AUDIO, made a new sub-directory below this sub-directory for the contents of the Performance Checks diskette. With the :\AUDIO prompt visible, type

```
MD PERFCHEK <Enter>
```

This will create a new second-level subdirectory below the C:\AUDIO directory. To move into this new directory, type

CD PERFCHEK <Enter>

The DOS PROMPT should now read

\AUDIO\PERFCHEK

You can now place the Performance Checks diskette in the A: drive and type

COPY A:*. * <Enter>

If you have other System One-related software, it is recommended that additional sub-directories under C:\AUDIO be created for each of these. For example, make a sub-directory named COMPDISC under AUDIO for the contents of the Compact Disc Player testing Applications Note companion diskette. Make a sub-directory named LOUDSPKR un-

der AUDIO for the contents of the diskette furnished upon request with the Loudspeaker Testing (by swept sinewave techniques) Applications Note.

If your System One is a DSP unit, make additional sub-directories under AUDIO named DSP, FASTEST, MLS, DSPCHEK, and CALIBWAV as described in the DSP User's Manual and copy the appropriate diskettes into each. See Figure 5-1 for a schematic representation of the "tree" directory structure with the recommended sub-directory names and the diskettes which should be copied into each.

As you build up your own collection of customized tests, procedures, and test data files from many devices under test, you will probably wish to create additional sub-subdirectories and locate your files among them according to some organizational plan appropriate for your work. In general, it is desirable to never allow more than 88 files of any one type

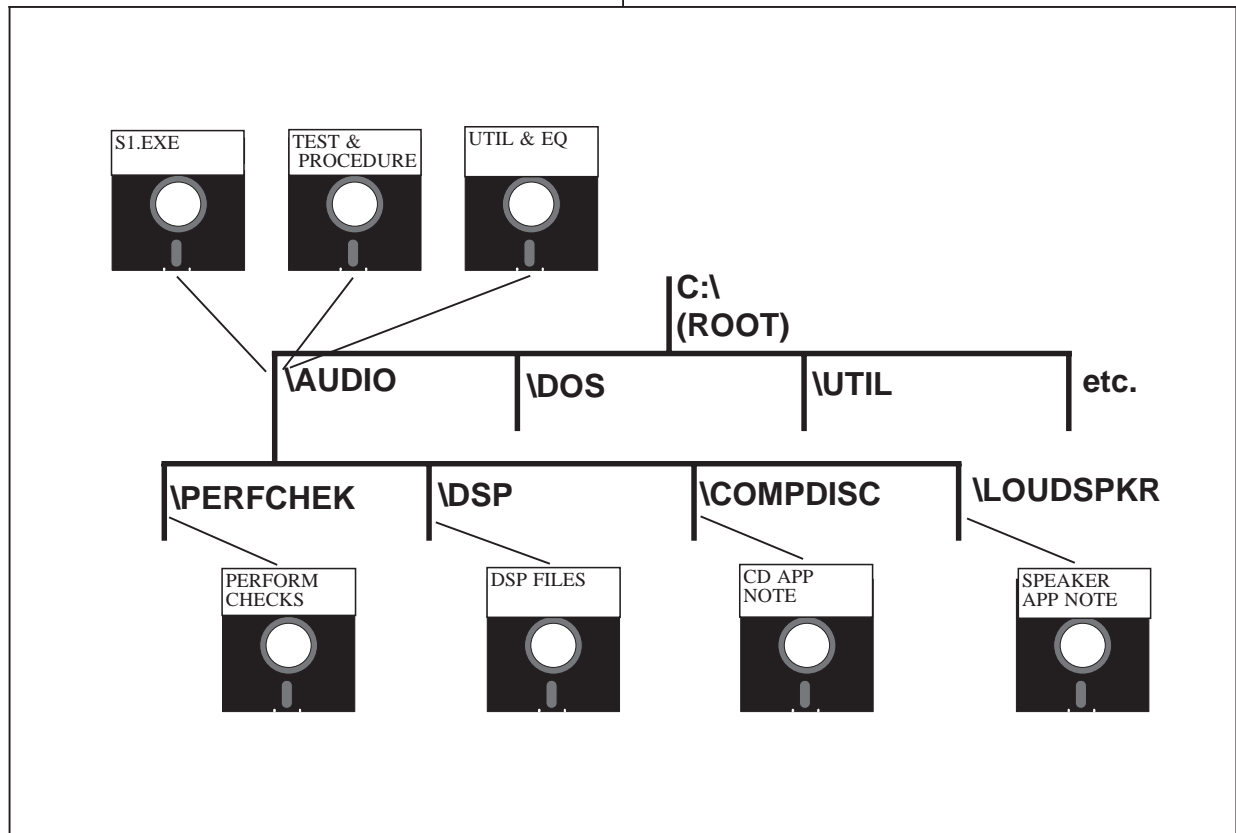

Figure 5-1 Recommended Hard Disk Directory Structure and Location of Distribution Files

(.TST, .PRO, etc.) to exist in one sub-directory since the S1.EXE "LOAD" command will only display the first 88 files in the sub-directory.

5.2.3. DOS PATH Command

If the DOS PATH command is not used and the name of an executable file (.EXE, .COM, or .BAT file) is typed, DOS looks for that file in the current directory. If it cannot locate the file, DOS responds

Bad command or file name

In order to be able to run S1.EXE and some of the other utility programs furnished from any sub-directory, it is highly desirable to use the facility of the DOS PATH command. The PATH command is normally placed in your AUTOEXEC.BAT file, so that it is executed each time your computer is booted. The PATH command simply contains a list of all the specific subdirectories you would like to have DOS look through in an attempt to find the executable file if it is not in the current directory. With the directory structure and file locations recommended above, only the C:\AUDIO sub-directory contains any of the furnished executable files. The form of the PATH command which should be added to your AUTOEXEC.BAT file is as follows:

```
PATH C:\AUDIO;
```

You may find that a PATH command already exists in your AUTOEXEC.BAT file, containing a list of sub-directories. If so, simply append

```
C:\AUDIO;
```

at the end. The semi-colon ";" must be used as a delimiter between consecutive sub-directory names. For example, if the C:\DOS; and C:\UTIL; sub-directories were already listed in your path command, the complete list after you have added C:\AUDIO; will read:

```
PATH C:\DOS;C:\UTIL;C:\AUDIO
```

After adding this sub-directory to the PATH command in AUTOEXEC.BAT, re-boot your computer for it to take effect. You will then find that you can type

```
S1 <Enter>
```

from any sub-directory on your hard disk and System One software will load.

5.2.4. DOS APPEND Command

The APPEND command of DOS has a similar effect for non-executable files (often called data files) to what the PATH command does for executable files. Whenever an application requires a specific data file (and the APPEND command is not in use), the application software looks for the data file in the current directory. For example, when you run a System One procedure, it expects to find the test files in the same directory. When a test file is loaded, it expects to find any related limit files, sweep tables, etc. in the same directory. If a required file cannot be found in the current directory, the error message

File not found

results. In order that the commonly-used System One files such as .EQ files, .SWP files, and .DSP programs (if you have a DSP unit) be usable from any sub-directory without having to copy them into every sub-directory which will be used, the APPEND command should be employed. The APPEND command has been part of DOS since DOS version 3.1. The APPEND command is again typically placed in the AUTOEXEC.BAT file so that it is executed each time the computer is booted. The simplest form of the command is:

```
APPEND C:\dirname1;C:\dirname2;
```

where dirname1 and dirname2 represents sub-directory names. Execution of this command at the time the computer is booted will cause DOS to search the specified directories for any requested data file not found in the current directory; in effect, those other specified directories are appended to the current di-

rectory. If it is desired to suppress the search through appended directories when a complete path name is supplied for the file, the additional “switch”

```
/PATH:OFF
```

should be added to the APPEND command. This is frequently desirable when saving tests to a specific directory or diskette, to avoid getting the “Filename already exists; Y to overwrite” message if the supplied file name exists in any of the appended directories. With this “switch” added, the recommended use of the APPEND command for the sub-directory structure and file location described above is

```
APPEND C:\AUDIO; /PATH:OFF
```

which will allow all the furnished .EQ, .TST, .LIM, and .SWP files to be used from any sub-directory on the disk. If your unit is a DSP unit, it is recommended that additionally the directories

```
C:\AUDIO\DSP;C:\AUDIO\MLS;C:\AUDIO\FAST  
EST;C:\AUDIO\CALIBWAV; /PATH:OFF
```

be added onto the APPEND command so that all DSP programs can be run from anywhere on the hard disk.

5.3. Diskette-Based Computers

If your computer does not have a hard (fixed) disk, the following sections describe how to prepare the furnished software for use.

5.4. DOS

Before S1.EXE can be run, the computer must be started (booted) with a suitable version of disk operating system, or DOS. DOS is normally purchased at the same time as the computer. There are different versions of DOS for different computers, and there may be several versions with progressively higher revision numbers (DOS 2.2, DOS 2.11, DOS 3.1, etc.) which are all compatible with a given com-

puter. System One software requires a DOS version of 2.2 or later. DOS is not furnished with System One due to copyright restrictions.

5.5. Diskette Copying

System One software is not copy-protected. It is good practice to copy the System One diskettes and use the copies in everyday applications, saving the distribution disks from Audio Precision in a safe place. The distribution disks have an adhesive tab over the notch near the diskette label, to prevent them from being written on or erased. Your working disk with test and procedure files should not have a write-protect tab, since you are likely to be frequently saving new files or modified versions of old files.

The distribution disks can each be copied onto working disks with the DISKCOPY command of DOS. With your DOS diskette in drive A, type

```
DISKCOPY A: B: <Enter>
```

You must then remove the DOS diskette from drive A and follow the computer prompt to place the source diskette (System One distribution diskette) in drive A:, a target (blank) diskette in drive B:, and strike a key when ready. The DISKCOPY command of DOS formats and copies in one operation. Diskettes can also be copied on single-diskette-drive computers by the same command. The single drive is treated alternately as both drive A: and drive B: by the operating system during this operation. The computer will prompt you on when to insert and re-insert the source and target diskettes during the copying process.

5.6. Bootable Disks

A “bootable” disk is one which can be used to start your computer. It must thus have DOS, including COMMAND.COM, on it. For computers with two diskette drives, the most convenient operation requires that a disk with the test, procedure, etc. files on it be bootable and remain in the A: drive. The diskette with S1.EXE need not be bootable, and will be used in the B: drive each time the software

is started. It may then be replaced with another diskette for test data storage or access to additional test and procedures files, since S1.EXE remains in memory until the computer is re-booted or until the QUIT command is executed from within S1.EXE

Single diskette drive computers will first use a DOS diskette in drive A: to start the computer. The S1.EXE diskette will then be loaded into memory from the A: drive. Finally, a diskette with tests, procedures, etc., plus COMMAND.COM will finally reside in the A: drive for continuing operation.

You can make bootable disks and format blank disks by use of the DOS FORMAT command; see your DOS manual for details. With your DOS disk in the A: drive, a bootable disk is made with the command:

```
FORMAT B:/S <Enter>
```

then place a blank diskette in drive B, press “Y” and <Enter>.

At the conclusion of this action, the bootable disk will have two hidden files (IBMBIO.COM and IBMDOS.COM) plus COMMAND.COM on it.

The “Tests and Procedures” files can be copied from the distribution disk in the A: drive onto a bootable diskette in the B: drive by the command

```
COPY A:*. * B: <Enter>
```

If your computer uses 360k diskettes, it may not be possible to copy all files from the Test and Utilities diskette onto a single bootable diskette since the hidden files and COMMAND.COM take up space. If your computer uses 720k, 1.2 Mb, or 1.44 Mb diskettes, you can also copy the files from the “Utilities and Equalization” distribution diskette on the bootable diskette in drive B: by repeating the last command above.

5.7. Starting System One

5.7.1. Two-Drive Operation

If you have a two-diskette-drive computer, place the bootable diskette with the test, procedure, limit, etc. files in the A drive and the diskette with S1.EXE in drive B. Turn the power on to the computer. The computer will go through a memory check operation which may take from half a minute to a minute, depending on how much memory is installed. It will then load DOS into memory from the bootable diskette in the A: drive and normally halts with the screen message A> , meaning that the A diskette drive is the selected (“default”) drive and the system is awaiting further instructions. Type

```
B:S1 <Enter>
```

This will load S1 into memory from the B: drive, but keeps A: (where the sample test and procedure files are located) as the default drive. Approximately 30 seconds of disk drive activity should result, followed by the appearance of the Audio Precision logo on screen. Press any key to go to the top level (COMMAND) menu across the bottom of the screen.

5.7.2. Single Drive Operation

If your computer has only one diskette drive, start the computer with any bootable diskette. When the A> prompt is obtained, remove the disk with which you booted, place the disk with S1.EXE on it in the drive, and type

```
S1 <Enter>
```

Approximately 30 seconds of disk drive activity should result, followed by the logo. Remove the disk with S1 from the drive, since S1 is now resident in memory, and replace it with the bootable disk containing the test and procedure files.

GRAPHIC SYSTEMS (VIDEO DISPLAY ADAPTERS)		
/D CODE	DISPLAY ADAPTER	RESOLUTION (H x V)
/D0	No Display	
/D1	Hercules Monochrome	720 x 348
/D2	CGA, Color-Compatible Monochrome Monitor	640 x 200
/D3	CGA, Color Monitor	320 x 200
/D4	MCGA, Analog Monochrome Monitor	640 x 480
/D5	MCGA, Analog Color Monitor	640 x 480
/D6	EGA, Monochrome Monitor	640 x 350
/D7	EGA, Color-Compatible Monochrome Monitor	640 x 200
/D8	EGA, Color Monitor	640 x 200
/D9	EGA, Enhanced Monitor 64k	640 x 350
/D10	EGA, Enhanced Monitor >64k	640 x 350
/D11	VGA, Analog Monochrome Monitor	640 x 480
/D12	VGA, Analog Color Monitor	640 x 480
/D13	Toshiba 3100 Plasma	640 x 400

Figure 5-2 Command Line /D Codes for Various Video Display Adapters

5.7.3. Graphic System Compatibility

System One S1.EXE software is compatible with most of the different graphic display systems found in PC-compatible computers. In most cases, the software is able to detect which graphics display system is installed in the computer and chooses the appropriate mode. It is unable, however, to detect certain situations such as CGA with monochrome monitor, EGA with monochrome monitor, or the Toshiba 3100 plasma display system. In these cases, the /D# command line option must be used when the software is started to force the correct mode. A command line option is simply a series of characters typed in following the characters S1 when starting the software from DOS. For example, to obtain the proper mode for a monochrome monitor driven from a CGA adapter card, type:

```
S1 /D2 <Enter>
```

For the Toshiba 3100 computer, type:

```
S1 /D13 <Enter>
```

See Figure 5-2 for a complete list of the available /D# options for various display systems.

5.8. Mouse Programs

If you plan to use a mouse with System One, a software program furnished with the mouse must be run prior to starting S1. This program is usually named MOUSE.COM or MOUSE.SYS.

5.9. More Automated Startup

After your initial familiarization with System One, you may wish to add automatic start-up procedures to your bootable diskette. Such autostart procedures can set aside a portion of memory as a virtual disk for faster operation, set the computer time and date according to a battery-backed clock-calendar card (if you have one), load other utility programs including MOUSE.COM, cause System One software to start automatically, and even select your own standard set of default conditions for the panels of System One. The CREATING YOUR CUSTOM SOFTWARE START-UP PROCESS chapter starting on page 28-1 gives some ways to do that.



6. GETTING STARTED QUICKLY

Assuming a hard-disk-based computer, boot the computer and use the CD (change directory) command to move into the AUDIO subdirectory where S1.EXE and most furnished tests and procedures are located. To start the software, type

```
S1 <Enter>
```

The Audio Precision logo should appear on your screen. Touching the <Esc> key will replace the logo with the COMMAND menu across the bottom of the screen as shown in Figure 6-1 below.

If S1.EXE software fails to load and an error message is displayed saying that insufficient memory is available, this is normally due to memory occupied by other programs called TSR (terminate and stay resident) programs which have previously loaded and stayed resident. The loading of such programs is typically controlled by the AUTOEXEC.BAT file which runs each time the computer is booted. This file must be modified to remove some of these programs in order to leave sufficient memory for S1.EXE to operate. Approximately 475k bytes of memory must be available (assuming a VGA display system) for S1.EXE software to load normally. Even with 475k, the automatic assignment of memory space within S1.EXE will not be adequate for most audio testing. It is possible to over-ride this automatic assignment process by use of the /B, /R, and /8 command line options. It is also possible to load S1.EXE into even smaller available memory (potentially as small as about 400k) and still accomplish useful testing by use of the /B, /R, and /8 command line options. See the “Controlling Memory

Usage” section of the “Creating Your Custom Software Start-Up Process” chapter for full information on use of these command line options.

You can move the menu cursor to the right by pressing the space bar, or move it in either direction by use of the and <+> keys at the lower right corner of the keyboard. You can get back to the COMMAND menu from any other screen by pressing <Esc>. If you are using a mouse, you can make menu selections by rolling the mouse horizontally and pressing either button. Pressing both mouse buttons simultaneously has the same effect as the <Esc> key. The menu structure of System One is shown in diagram form in the QUICK REFERENCE chapter and is more fully described in the MENUS chapter.

6.1. Running Stored Procedures

A number of example tests, procedures, and limit files have been furnished on one of the diskettes. Running the procedure named SELECT.PRO will present you with a menu of specific demonstration procedures which can be selected and run. Viewing these procedures and tests can give you a good idea of many of the functions of System One. Interrupting the procedure to examine the panel setups and procedure listings in detail will later be helpful as you begin to create your own tests and procedures.

To run a procedure, press <Esc> to go to the command menu, followed by <L> <P> for Load Procedure. The screen will show you a listing of the procedure files in the current directory. Unless you have a mouse installed or a keyboard with arrow

```
CMD: RUN PANEL LOAD SAVE APPEND EDIT HELP XDOS DOS NAMES IF UTIL QUIT COMPUTE :  
Run procedure, test, or graphs          AUDIO PRECISION SYSTEM ONE, v 2.10
```

Figure 6-1 Command Menu

keys separate from the numeric keypad, be sure the Num Lock key is in the condition which enables arrow key action rather than digit keys. Use the arrow keys to move the cursor onto SELECT.PRO and press <Enter> to load it into the computer. Then press <R> <P> for Run Procedure. A screen will be displayed with a number of demonstration procedures, selectable by pressing one of the numeric keys from 0 through 9. A good place to start is with selection "0" for a quick performance check of your system. No audio cables should be connected to the generator output when this procedure is being run. The procedure runs through a quick check against published specifications of a number of System One's key parameters. If you wish to temporarily pause during any test in order to examine the data in more detail, press the <F10> key once to pause and again to proceed with the test and procedure. The procedure ends with a summary listing of any out-of-specification measurements. The

<PgDn> and <PgUp> keys can be used to look at the entire summary. Pressing the <Enter> or <Esc> key takes you back to the initial set of procedures.

Selecting "1" will run a demonstration procedure of System One's analog indication and analog generator control capabilities. It also demonstrates how a procedure can have a prompting message to the operator on the bar graph screen. Other procedures will show the results of stored tests on multi-track tape recorders and stored tests made with a DSP module. Still other procedures are actual working tests for test devices such as power amplifiers and compact disc players.

To finally exit from SELECT.PRO back to the S1.EXE command menu, press "9".

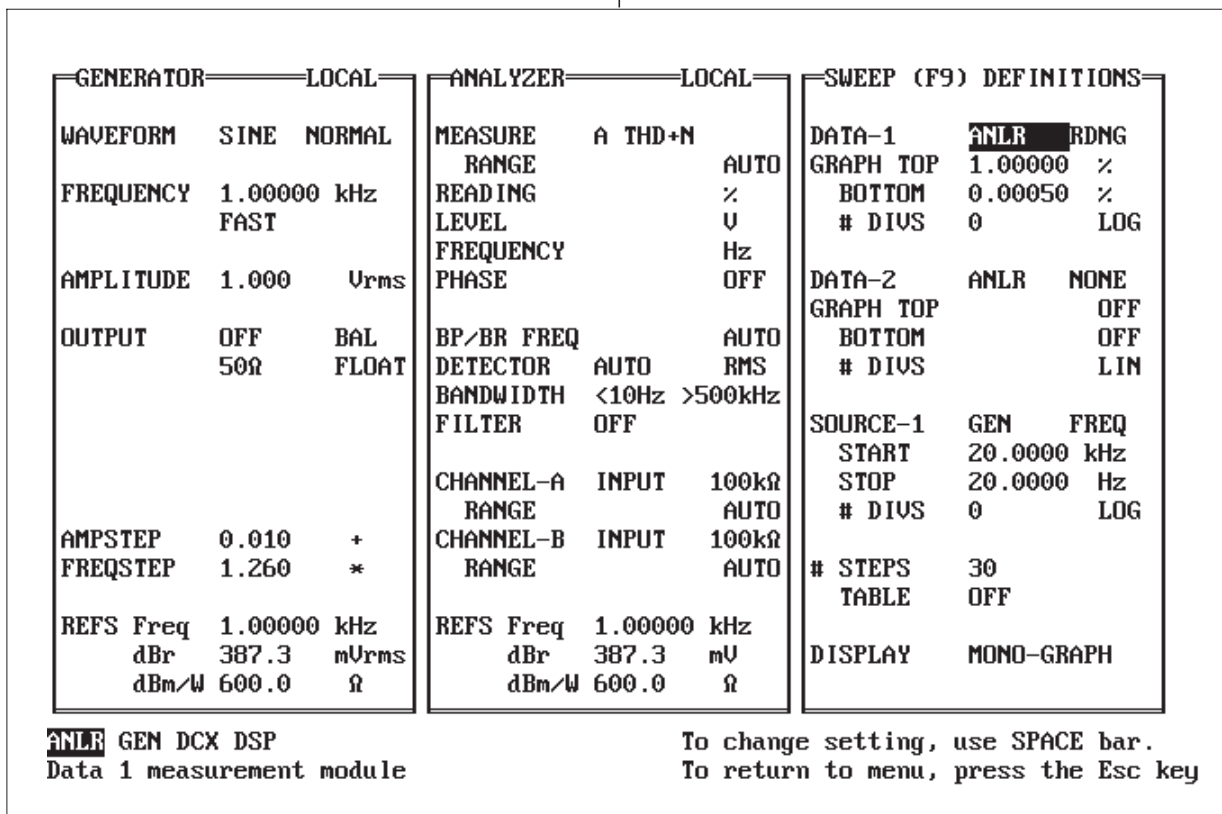

Figure 6-2 Panel Display

6.2. Viewing and Running Tests

You may also load any test individually via the <L> <T> (Load Test) key sequence from the menu, selecting the test name from the displayed directory with the cursor, and using <Enter> to bring the test into the computer. You may then use <F7> or Run Graph to examine the stored data, and use <Esc> <P> to go to the panel to examine the setup.

Now that you have a quick idea of System One function, you may wish to perform actual audio tests on external devices. The example .TST files furnished on the distribution disk provide many of the common audio tests. You can Load a Test and press <F9> or Run Test to run the test on an external device. If you do run the test and wish to save the data via Save Test, supply another file name to avoid destroying the data originally stored. You may also wish to begin experimentation with the panel and menus. Not all functions may be obvious, however; therefore, the following paragraphs briefly describe operation of System One for use as an introduction or as reference. More complete descriptions are in the chapters which follow.

6.3. Panel

PANEL mode is used to set up tests for saving and later re-use, or to make impromptu, “spot” measurements. From the menu, press <P> or move the cursor to PANEL and press <Enter> to go to the panel. You should see a full-screen display similar to that shown in Figure 6-2.

6.4. Making Your First Test Graph

The panel which you see will be the setup for the test you last loaded, which may be the final test of the last procedure which you ran. It is recommended that you start with the standard power-on set of panel defaults. To do so, press <Esc> <L> <T> and select DEFAULT.TST from the displayed directory. Press <P> to go to the panel. A cursor will be located on one of the fields on the panel. A second style of position marker will also be visible in PANEL mode near the bottom left cor-

ner of the screen; this indicates where entries will appear when entering numbers into a numeric entry field. Use the arrow keys to move the main cursor to the OUTPUT OFF field on the GENERATOR panel. Press the space bar; at the lower part of the screen, the choices for generator on/off conditions will appear with a cursor (“choices cursor”) now on the A, meaning A channel on, B channel off. Press the <Enter> key to select the A condition.

Use the arrow keys (or mouse) to move the main cursor to the lower portion of the ANALYZER panel, onto the line labeled CHANNEL-A and the field indicating INPUT. Operate the space bar to move the “choices” cursor from INPUT to GEN-MONITOR and press the <Enter> key to select GEN-MONITOR. This connects a direct internal cable between the GENERATOR channel A output and the ANALYZER channel A input, and the bright numbers near the top of the ANALYZER panel should begin indicating system residual THD+N READING, generator LEVEL, and generator FREQUENCY. For a 20 kHz to 20 Hz sweep of system residual distortion versus frequency (at 500 kHz measurement bandwidth), press the <F9> function key. The panel will be replaced with a graph and the data will plot onto the graph as the measurements are made. The computer will “beep” when the last measurement is made. You can return from graph to panel by pressing <Enter> or <Esc> <P>.

6.5. Graphic Cursors

With a graph displayed on screen, touching either horizontal arrow key will cause a graphic cursor and numeric display areas to appear on screen. Touching the left arrow first will cause the cursor to first appear at the right edge of the screen and move down into the data from the right end. Touching the right arrow first will cause the cursor to first appear at the left edge and move up into the data from the left. The left-hand numeric display block, near the top of the graph, will display the X-axis value at the cursor location. The second (and third, if three numeric blocks are displayed) displays are the Y-axis

values of the DATA-1 line (solid line monochrome, green line color) and the DATA-2 line (dashed line monochrome, yellow line color).

6.6. Panel Cursors

The vertical arrow keys move the cursor up and down from field to field within any of the panel sections (GENERATOR, ANALYZER, and SWEEP (F9) DEFINITION). The horizontal arrow keys move the cursor between the three panel sections or, in the cases where a panel section has changeable fields on the same row, between those fields. *When the cursor is moved between panel sections, it goes to the field which it last occupied on that section.* The Num Lock key controls whether the numeric keypad functions for numeric entry or for cursor control via the arrow keys, <Home> and <End>, <Pg Up> and <Pg Dn>, and <Ins> and . <Num Lock> is a “toggle” key; each time it is pressed, it switches the keypad to the opposite function.

Depending on your keyboard, you may find it most convenient to leave <Num Lock> in the cursor control position and use the top row of keys of the main keyboard for numeric entry, unless you have a mouse option (see MOUSE chapter). If the mouse is present, you may use it for cursor control. The <Shift> key serves as a temporary over-ride of the selected <Num Lock> function. If <Num Lock> is in the cursor control condition, holding down the <Shift> key while pressing keys on the numeric keypad will produce numeric entry (and vice versa).

6.7. Changing Contents of Fields

Certain fields are display only. Examples include label fields such as WAVEFORM on the GENERATOR panel and MEASURE on the ANALYZER panel, the four measurement display fields near the top of the ANALYZER panel, and the POST-EQ field on the generator panel when EQSINE is selected. The cursor cannot be placed on display-only fields. Most fields are either multiple choice fields or numeric entry fields.

6.8. Multiple Choice Fields

When the cursor is on a multiple choice field such as BAL UNBAL CMTST on the GENERATOR panel section, the choices will be displayed on the lower portion of the screen with the “choices” cursor on the current selection. The space bar may be used to move the cursor to the right through all the choices, or the <+> and keys (at the extreme lower right of most IBM-compatible keyboards) may be used to move the cursor either right or left. When the cursor is on the desired choice, press <Enter> to make the selection. If you have a keyboard which has arrow keys separate from the numeric keypad, you may find that the key causes choices cursor movement only when <Num Lock> is disabled; the key works as a decimal point in the <Num Lock> position.

6.9. Numeric Entry Fields

When the cursor is on a numeric entry field such as those to the right of the words AMPLITUDE and FREQUENCY on the GENERATOR panel, numbers can be entered directly with the number keys. System One accepts k as an abbreviation for kilo-, m as milli-, u as micro-, n as nano-, and will also accept scientific notation such as 1E3 as an alternative to 1000 or 1k. The numbers and characters typed will first appear at the blinking underline marker at the bottom of the screen. Errors can be corrected with the backspace, prior to pressing <Enter> to actually enter the data. For numeric entry fields that have an associated multiple choice field for units (such as generator AMPLITUDE), you may change both numbers and units simultaneously by first typing the numbers and then pressing the space bar. This moves the “choices” cursor in the units field, showing the choice of units available at the bottom of the screen to the right of the numbers. Use the space bar as necessary to place the cursor on the desired unit, then press <Enter> to enter both the number and the new units simultaneously.

6.10. Blanked Fields

Certain fields are blanked in some modes and visible in others. Examples include the sine burst control fields in the lower-central area of the GENERATOR panel and the IM-FREQUENCY field immediately above the FREQUENCY line of the GENERATOR panel. These fields are normally only visible when the relevant mode is enabled. For example, the sine burst control fields become visible when SINE BURST is selected at the top of the GENERATOR panel as WAVEFORM. However, the contents of these fields will also become temporarily visible when the cursor is placed on them, even when blanked.



7. QUICK REFERENCES

This chapter brings together many key information items from later chapters of this manual. Full descriptions of the information shown here will be found in the sections to which the references are made.

7.1. Menu System

System One's system of menus are used principally for computer-intensive activities such as loading files from disk to memory, saving files from memory to disk, linking together tests and other actions into procedures, "connecting" limit, sweep, or equalization files to tests, controlling external devices, performing computations on data, etc. See the MENUS chapter for more information.

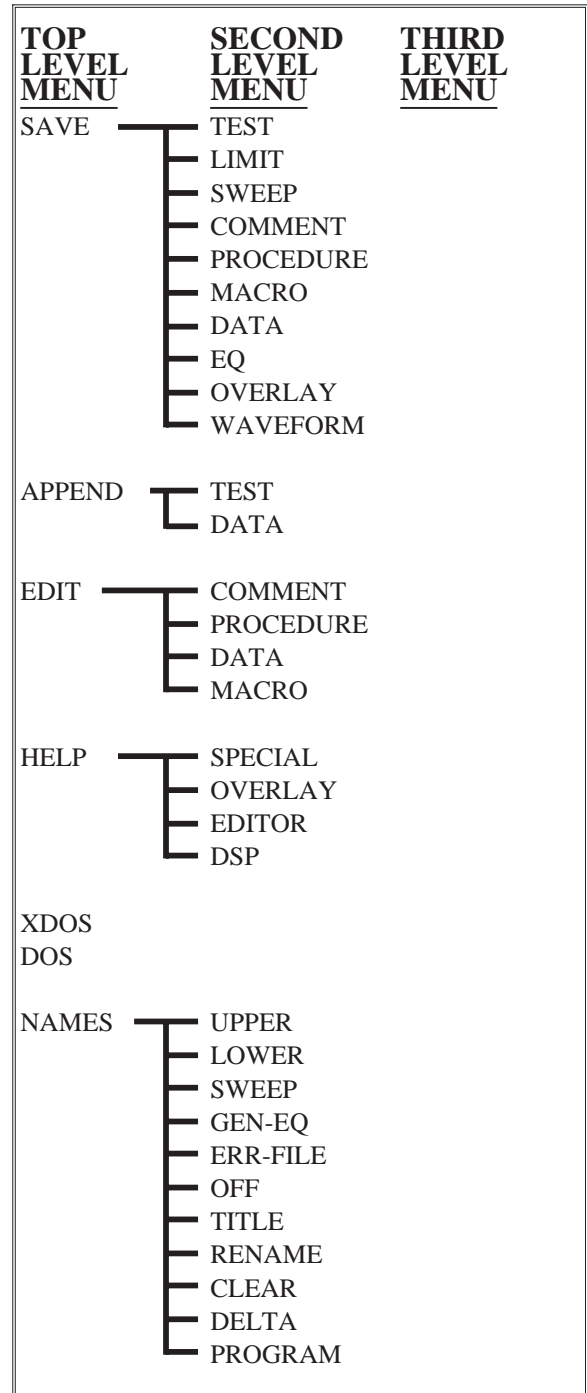
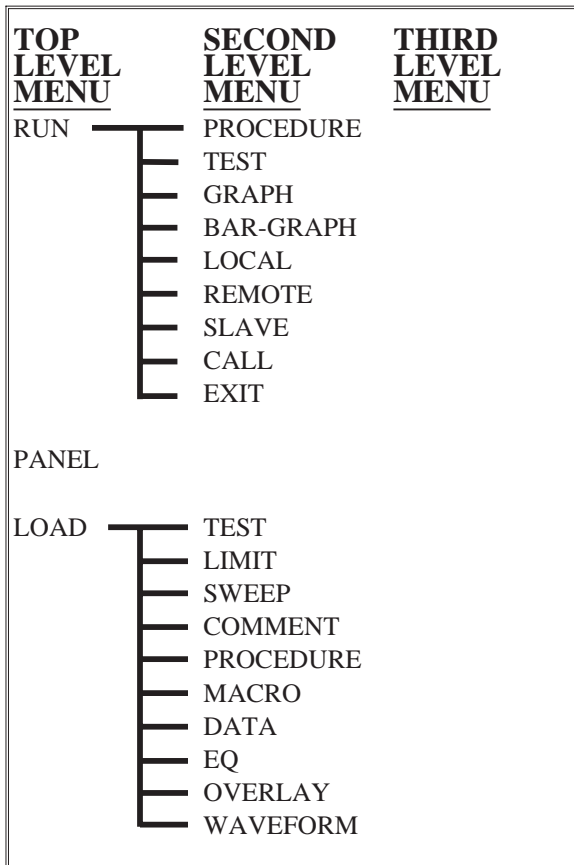

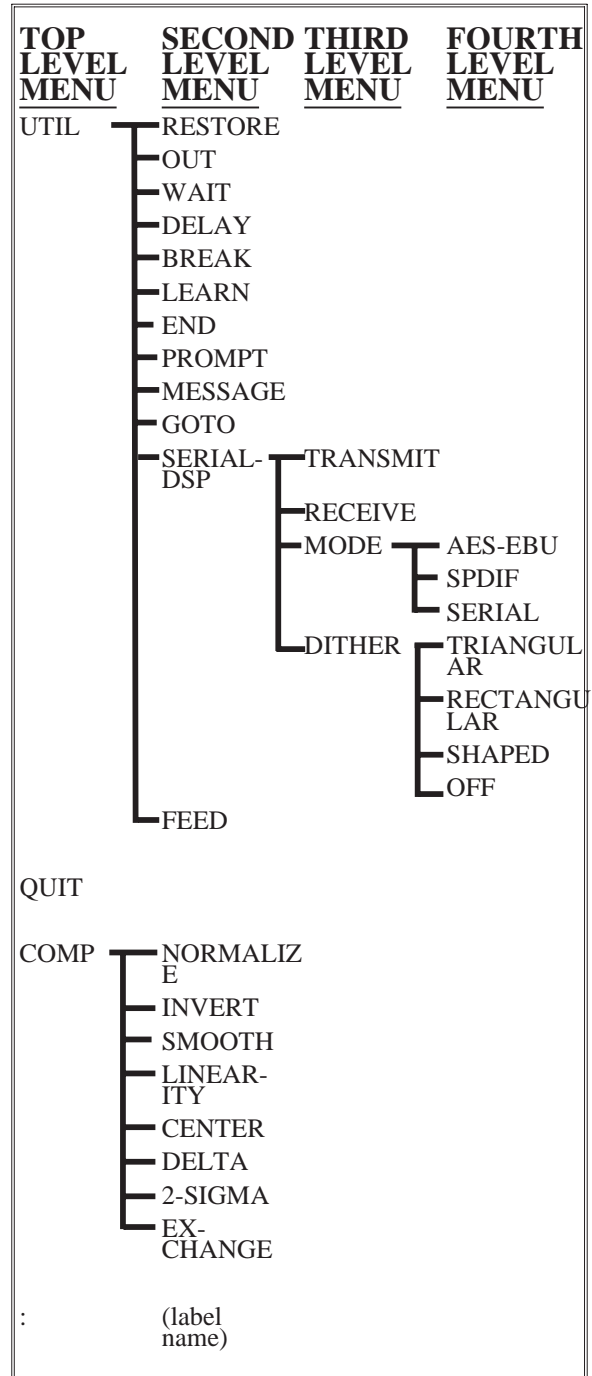
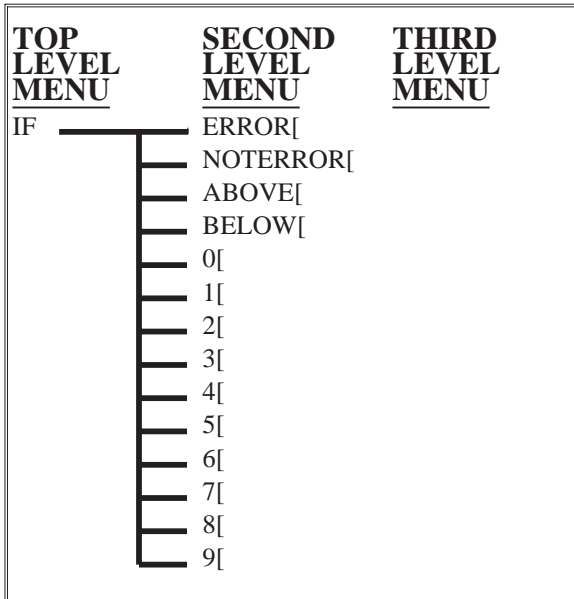

7.2. Generator Panel

System One's (analog) generator is controlled from this panel. The available choices for the various selectable multiple-choice fields are shown in "exploded" form. In addition, direct numeric entry of the desired value can be made into the generator FREQUENCY and AMPLITUDE fields.

A number of the fields are inter-dependent. For example, the choices of waveform modifier (Normal vs Burst, etc.; 4:1 vs 1:1; White vs Pink, etc.) depend upon which waveform has been selected. The Burst On, Burst Interval, and Burst Low Lvl fields all appear only when Sine Burst is selected, and some of those fields disappear when Sine Trig or Sine Gate are selected.

For more information, see the GENERATOR chapter beginning on page 9-1.

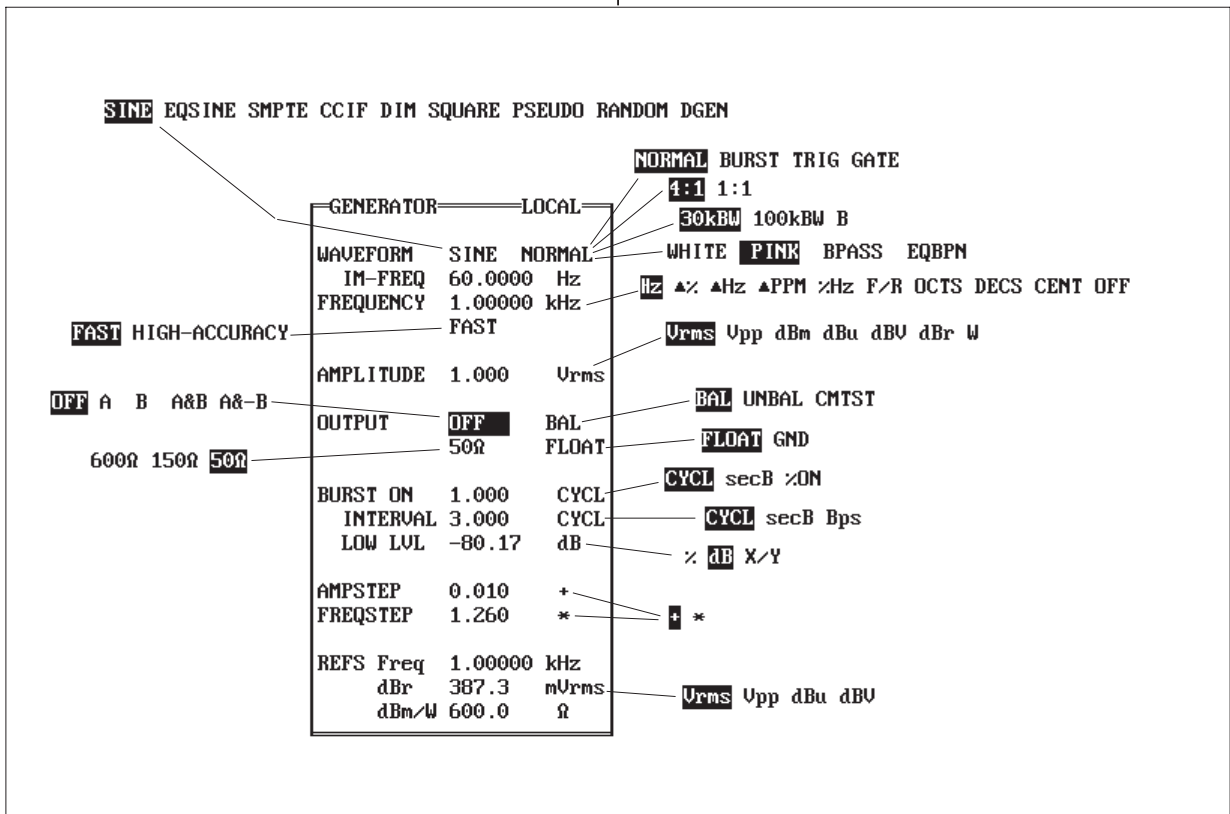

Figure 7-3 GENERATOR Panel

7.3. Analyzer Panel

System One's (analog) analyzer is controlled from this panel, and real-time results are displayed on the panel. The available choices for the various selectable multiple-choice fields are shown in "exploded" form.

The units for the Reading meter depend upon which function is selected on the top (Measure) line. Reading meter units are further sub-divided into relative units (% , dB, X/Y, and PPM) versus absolute units such as Volts, dBm, etc.

For more information, see the ANALYZER chapter starting on page 10-1.

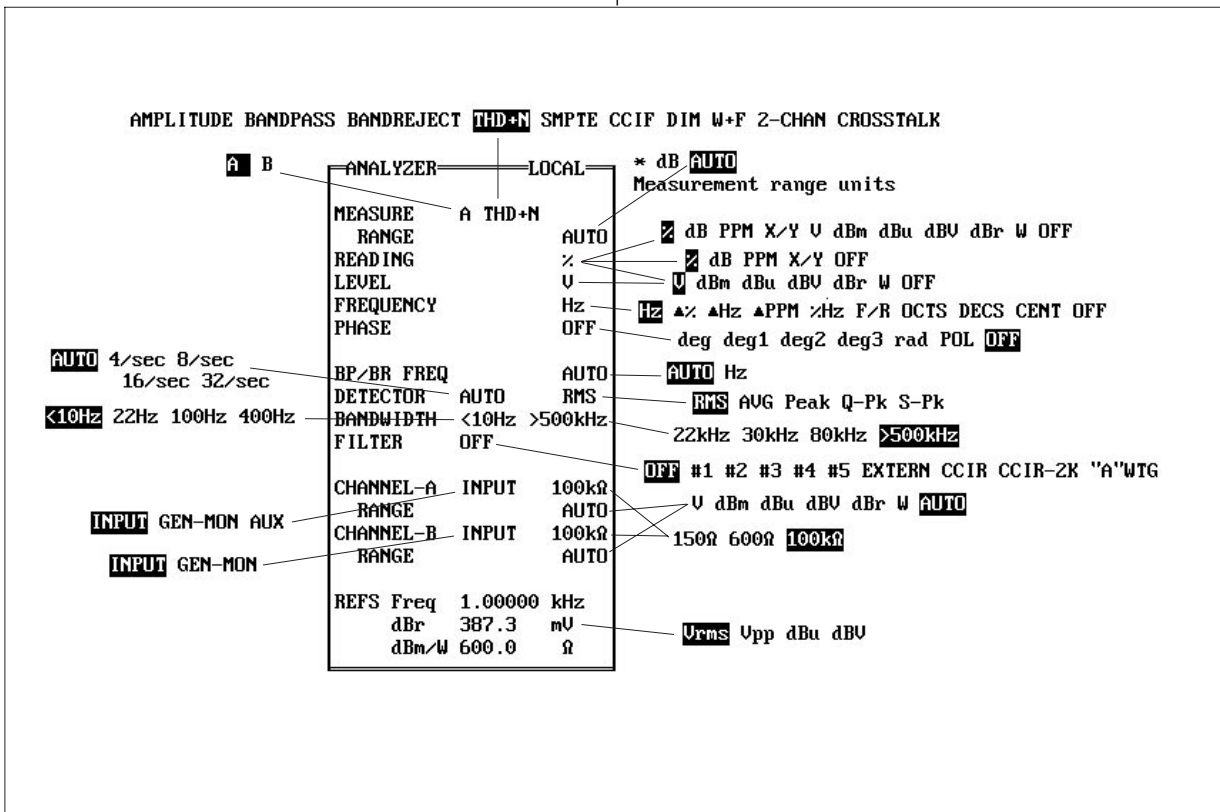

Figure 7-4 Analyzer Panel

7.4. Sweep (F9) Definitions Panel

This panel determines which stimulus parameter will be swept (stepped) during a test as the independent variable, also forming the horizontal axis calibration. It determines which one or two measured values will be graphed as dependent variables against that independent variable, along with selection of displayed units and graphic coordinates. The SWEEP (F9) DEFINITIONS panel also permits displaying two measured parameters versus one another in X-Y fashion, automatically testing both channels of a stereo or two channel system, scanning across channels of the SWR-122 family of switchers, plotting measured data versus time in chart recorder fashion, and “nesting” one independent variable sweep inside another (such as an amplitude sweep inside a frequency sweep). See the SWEEP (F9) DEFINITIONS (Chapter 11) for more information.

The choices shown in “exploded” form in Figure 7-5 may depend upon other selections. For example, the “RDNG LEVEL FREQ PHASE NONE” measurement parameter choices are available only when the ANLR (analyzer) module is selected at DATA-1 or DATA-2. Selecting the GEN, DCX, or DSP modules instead of ANLR will cause a different set of measurement parameters to become available. In turn, the units of measurement depend upon the parameter selected. DSP parameters and units depend upon the particular DSP program which has been down-loaded to the DSP module. If no DSP program has been loaded, no parameters or units will be displayed.

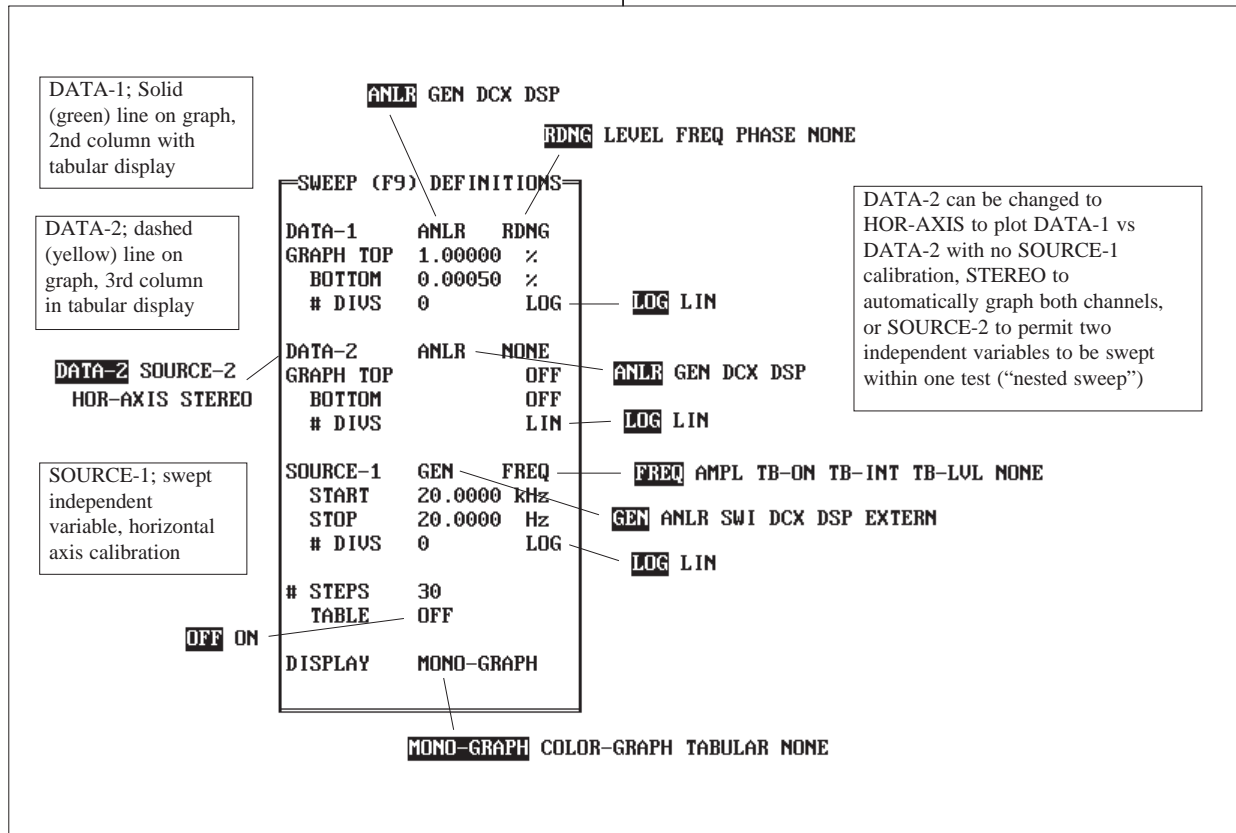

Figure 7-5 Sweep (F9) Definitions Panel

7.5. Software Start-Up Options

By including one or more “command line options” following the characters “S1” when System One software is started from the DOS prompt, many variations in the operation of the software can be obtained. These options are summarized below. A short listing of the available options can be obtained from DOS by typing S1 /? <Enter> or S1 /HELP <Enter>.

7.5.1. Print-out Options

/F [#,#] controls printer formatting (first digit) and single versus bi-directional printing (second digit). Normal formatting has graphs horizontally centered on the page, with multiple graphs per page if the vertical height plus number of lines in the Comments editor permits. Disabling formatting causes no line feeds or form feeds after the last line of the graph of comments. A first digit of 0 disables formatting; a first digit of 1 (or not using the /F option at all) provides normal formatting. The second digit must be 0 for one-directional printing and 1 for bi-directional printing. Thus, /F0,1 produces unformatted graphs via bi-directional printing and /F0,0 disables formatting and causes uni-directional printing. See the table on page 15-3 for a more complete description of the print formatting.

/P# [,#,#] describes the printer mode to be used and specifies the height and width, in inches, of the resulting graph. See the table on page 15-5 for detailed information.

/G enables graphics reporting mode, in which a graphics display file (.GDL extension) can be saved via the SAVE GRAPHICS menu command. This file can then be used later by the plotter driver programs PLOT.EXE or POST.EXE. See the Plotter section on page 15-7 of the HARD COPY PRINT-OUT chapter for more details.

7.5.2. Memory Control Options

/R specifies the amount of memory, in kbytes, which S1.EXE will set aside for DOS actions and programs running under the XDOS or DOS exits from S1. See page 28-6 for more information.

/B#,#,#,#,# specifies the size of the six buffers which have the principal variable effect on the amount of memory occupied by S1.EXE. See page 28-8 for more information.

/8 disables the Image Store and sweep-erase-repeat capabilities normally invoked by <Alt><F8>, <F8>, and <Alt><F9>, so that the 16k (CGA) to 38k (VGA) required by those functions is available for other purposes. See page 28-6 for details on how to use this option.

/&filename sets the memory swap mode and specifies the disk filename into which the contents of the six buffers will be swapped at XDOS and DOS exits, leaving approximately 220 kbytes of memory then available for programs running from DOS. See page 28-9 for data.

7.5.3. Display Related

When S1.EXE software is started, it is normally able to determine what type of display system is present in the computer and support it accordingly. In certain cases (such as a CGA display system with a monochrome monitor), this automatic display mode selection may not work. The /D# option can be used to select the appropriate mode. See the table on page 5-7 for complete information.

When overlay files (.OVL) are used instead of test files (.TST) in order to retain some panel settings from the previous test, the video appearance of the “punched out” fields may be controlled by the /V# option. See the figure on page 25-11 of the PROCEDURES chapter for information.

7.5.4. Miscellaneous

When S1.EXE software operation is terminated by the QUIT command, it automatically saves the current test, procedure, and macro files as APLAST\$\$TST, APLAST\$\$PRO, and APLAST\$\$MAC. If System One software is then later started with the /L (for last) option, it will load those files. See page 28-4 for information.

The /I# option may be used at software startup to tell the system at which address the PCI-2 interface card is to be found, or that there is no interface card installed. See page 28-5 for information.

An optional version of System One has been designed for German and Nordic countries with a slightly different set of generator source impedances and analyzer input impedances than used in most of the rest of the world. When this special hardware

version is in use, the software should be started with the /E option to show the proper selections on the panels and to compute the proper dBm values.

For more information on command line options, see the Command Line Options section of the CREATING YOUR CUSTOM SOFTWARE START-UP PROCESS Chapter starting on page 22-12.

7.6. Function Keys

Many of the most-used operations of System One software are controlled by the function keys <F1> through <F10>. Figure 7-6 summarizes the functions available; this screen can be displayed from within the software at any time via <Esc> HELP SPECIAL.

SPECIAL FUNCTIONS KEYS	
F1	Turn generator off NOW! Also aborts procedure playback.
Alt-F1	Aborts procedure playback without changing generator.
F2	Display readings on BAR-GRAPH screen.
F3	Set GEN dBr reference to the present GEN amplitude setting.
Alt-F3	Set GEN Freq reference to the present GEN frequency setting.
Ctrl-F3	Regulate as specified (and if enabled) on Regulation panel.
F4	Set Analyzer dBr reference to the present measurement.
Alt-F4	Set Analyzer Frequency reference to the present measurement.
F7	Plot data from memory. Use graph already on-screen if possible.
Alt-F7	Plot limits.
Alt-F8	Store graphics image of screen into memory.
F8	Recall previously saved graphics.
F9	Measure and plot new data. Use graph already on-screen if possible.
Ctrl-F9	Measure and plot new data, keeping old data.
Alt-F9	Auto-repeat test with erasure of last trace.
Shft-F9	External test with termination on reversal to panel frequency.
F10	Pause/continue (used during sweeps and procedures).
Alt-F10	Single step procedure (used after F10).
Ctrl-F10	Pause procedure for user numerical input.
*	Special Print-screen with comments.
Shft-PrtSc	Normal ROM-BIOS Print-screen.

Figure 7-6 Description of Function Key Operation (HELP SPECIAL screen)

```

===== LOAD AND SAVE INFORMATION =====

Last loaded or saved Procedure (.PRO) file =
Last loaded or saved Comment (.TXT) file =
Last loaded or saved Data (.DAT) file =
Last loaded or saved Macro (.MAC) file =

File currently in memory =
(Last loaded or saved .TST, .LIM, .SWP, .EQ, or .OVL file)

=====

LOAD: TEST LIMIT SWEEP COMMENT PROCEDURE MACRO DATA EQ OVERLAY WAVEFORM
Load test from .TST file AUDIO PRECISION SYSTEM ONE, v 2.10

```

Figure 7-7 LOAD and SAVE Panel

```

===== SYSTEM ONE STATUS AND INFORMATION =====

Maximum Data Points = 410 ( 0 used)
Internal EQ, Limit, Sweep Points = 200
Maximum Edit-Data Size = 24657 ( 0 used + 0 in copy buffer)
Maximum Edit-Procedure Size = 13523 ( 0 used + 0 in copy buffer)
Maximum Edit-Comment Size = 13523 ( 0 used + 0 in copy buffer)
Maximum Edit-Macro Size = 3002 ( 0 used + 0 in copy buffer)
Bytes Reserved for DOS = 65536
DSP Acquisition Buffer Size = 0

PCI type = 1 (at address 238 hex)
Display type = 12 (VGA, Color Monitor)
Printer Status = 90 hex, Selected, Not Busy, Paper OK
Graph Print = Mode 3, Portrait, 3.3" High (72 dpi), 5.3" Wide (240 dpi)

Local Instruments:
(updated by UTIL RESTORE) GEN = Available
ANLR = Available
DCX = Not Connected
SWI = Not Connected
DSP = Available (+ DIO opt.)
CPU = 80386 with 80387 math coprocessor

=====

HELP: SPECIAL OVERLAY EDITOR DSP PANEL
Show special functions keys help screen AUDIO PRECISION SYSTEM ONE, v 2.10

```

Figure 7-8 HELP Panel

what microprocessor type is used as the main CPU (8088, 8086, 80286, etc.) and whether there is a math co-processor installed.

The NAMES screen, shown in Figure 7-9, displays the names of the files which may be attached to the file in main memory by use of the various NAMES commands. These include the DELTA file, upper and lower comparison limits files, generator sweep (step table) file and equalization file, error reporting file, and DSP program file and version. The NAMES panel, like the LOAD and SAVE panel, also displays the name of the file currently in main memory.

7.8. Procedures

A “procedure” (.PRO file) is a technique used in S1.EXE software to more-fully automate a complete testing process. Procedures can automatically load and execute tests, compare results to pre-defined limits, control external devices, wait for external actions to be completed, prompt the operator to take actions, branch to different portions or to sub-procedures upon failure (or passing) of test limits or upon operator input, save results to disk, print results, etc. See the Procedures chapter beginning on page 25-1 for full information on procedures.

Procedures may be created in a “keystroke learn mode” initiated by the UTIL LEARN command, or directly in an ASCII text editor or in EDIT PROCE-

Procedure Listing Appearance	Manual Text Representation	Function
/F10	<F10>	Pause
/A9	<Alt><F9>	Run sweep, erase repeating test
/C9	<Ctrl><F9>	Run test without erasing previous dat
/F9	<F9>	Run test
/S9	<Shift><F9>	Run external test, terminate on reversal to generator panel frequency
/A8	<Alt><F8>	Store graphic image of screen
/F8	<F8>	Display stored graphic image
/A7	<Alt><F7>	Graph limits
/F7	<F7>	Re-graph data in memory
/F6	<F6>	Re-transform (DSP only)
/A6	<Alt><F6>	Re-send data to PC without new transform (DSP)
/F4	<F4>	Set analyzer dBr reference
/A4	<Alt><F4>	Set analyzer relative frequency reference
/F3	<F3>	Set generator dBr reference
/A3	<Alt><F3>	Set generator relative frequency reference
/C3	<Ctrl><F3>	Initiate one REGULATION cycle
/F2	<F2>	Display bargraph
/A1	<Alt><F1>	Abort procedure without turning generator off
/F1	<F1>	Turn off generator and abort procedure
/E	<Esc>	Go to command menu
/R	<Enter>	
*	<*>	Dump screen to printer

Figure 7-10 Special Keystroke Appearance in Procedure Listings

Screen Display	Learn Mode Keystroke	ASCII Editor Keystrokes	Function
↑	<up arrow>	<Alt>24	cursor up
↓	<down arrow>	<Alt>25	cursor down
←	<left arrow>	<Alt>17	cursor left
→	<right arrow>	<Alt>16	cursor right
␣	<Ctrl><Home>	<Alt>235	panel cursor to ref. position
␣	<Home>	<Alt>187	panel cursor to top
␣	<End>	<Alt>195	panel cursor to bottom
␣	<PgDn>	<Alt>197	next set of panels
␣	<PgUp>	<Alt>189	last set of panels
␣	<Ins>	<Alt>198	insert mode (toggle to overwrite)
␣		<Alt>199	decrement value
+	<+>	<Alt>43	increment value
*	<*>	<Alt>42	screen dump print-out
␣	<Ctrl><right arrow>	<Alt>232	right end of mult. choices
␣	<Ctrl><left arrow>	<Alt>231	left end of mult. choices
␣	<Ctrl><PgDn>	<Alt>234	bottom of editor
␣	<Ctrl><PgUp>	<Alt>248	top of editor
␣	<Alt><P>	<Alt>141	punch out present field
␣	<Alt>	<Alt>164	blank all panel fields
␣	<Alt><R>	<Alt>128	restore all panel fields
␣	<Alt><A>	<Alt>146	increment overlay video attribute
␣	<Alt><S>	<Alt>147	decrement overlay video attribute
␣	<Alt><Z>	<Alt>160	set overlay video attribute to zero

Figure 7-11 Screen Appearance of Keystrokes Which May Be Used in Procedures and Macros

GW GEN Waveform	SM Settling Mode
GF GEN Frequency	SI Switcher channel A INPUT
GA GEN Amplitude	SO Switcher channel A OUTPUT
GO GEN Output OFF/ON	RE Regulation Enable
GB GEN Tone Burst duration	RM Regulation Measurement
GS GEN Amplitude step size	RV Regulation Parameter to be Varied
GR GEN dB reference	
LC Analyzer Channel Select	XU DCX DMM Units
LM Analyzer Measurement mode	X1 DCX DCV Output #1
LF Analyzer BP/BR Frequency	X2 DCX DCV Output #2
LD Analyzer Detector type	XD DCX Digital Output
LH Analyzer High pass filter	XA DCX Port A 8 bit output
LL Analyzer Low pass filter	
LO Analyzer Optional filters	DS DSP Setting 0
LA Analyzer Channel A input source	DR DSP Sampling Rate
LB Analyzer Channel B input source	DI DSP Input Type
LR Analyzer dB reference	D1 DSP Channel 1 Input Source
S1 Sweep Data-1 measurement	D2 DSP Channel 2 Input Source
S2 Sweep Data-2 measurement	DO DSP Output Channel(s)
SS Sweep Source-1 stimulus	
SN Sweep Number of steps	
SD Sweep Display Mode	

Figure 7-12 Two-Character Codes to Jump to Panel Fields

DURE mode. See Figure 7-10 for a listing of the relationship between common S1.EXE commands as represented in procedures versus the text of this manual, plus short definitions of their function.

Certain keystrokes useful in procedures cannot be directly entered in EDIT PROCEDURE mode. In some text editors, they may be entered by use of the <Alt> key plus the numeric keypad. Alternately, they may be entered during UTIL LEARN mode and then “cut and spliced” with the <F6> and <F5> keys to the desired location. See Figure 7-11 for a presentation of the appearance of these keys in EDIT PROCEDURE mode and their function.

During procedures, it is sometimes necessary for panel conditions to be changed during the course of a test or between tests. A set of two-character commands has been created which jump the panel cursor to many of the major panel fields to simplify these panel moves. They may also be a convenience during normal test setup and operation of System One. See Figure 7-12 for a listing of these codes.

8. UNITS

The GENERATOR Panel and the ANALYZER Panel are both capable of expressing amplitude in a number of different units. Generator amplitude units include Volts rms, Volts peak-to-peak, dBm, dBu, dBV, dBr, and Watts. The measurement module units include the same decibel and Watts units as the generator but do not specify rms for Volts, since rms is only one of four detector response types that the System One user may select. Unique to the measurement module are several relative amplitude units for two-channel measurements with A-version hardware (dB, X/Y, %, PPM).

The sine burst mode of the BUR-GEN module introduces several units for control of the burst parameters. These provide the ability to define tone bursts in terms of number of cycles, time, percent duty factor, and repetition rate.

The frequency measured by the analyzer module can be expressed in many units relative to a frequency reference. Phase can be expressed in degrees or radians, and four types of degree units may be selected to provide the optimum display.

8.1. Amplitude Units

Vrms (generator only)

This is the root-mean-square open-circuit value (emf) to which the generator sinewave is set. As an open circuit value, it is independent of generator source impedance and does not use the load resistance information. When complex waveforms, such as the intermodulation distortion, squarewave, and noise waveforms are selected, generator calibration is in terms of the rms value of a single sinewave which would have the same peak-to-peak value as the selected complex waveform.

When a voltage unit is used, the GENERATOR AMPLITUDE field directly specifies the generator open-circuit voltage (sometimes called emf, or elec-

tro-motive force). Unless the external load impedance is infinite, the actual voltage delivered to the load will be less than this open circuit voltage since the selected generator source impedance and the external load impedance act as a voltage divider. For example, if the 50 Ohm source impedance is in use and the generator output is connected to the analyzer input with the analyzer 100 kilohm input termination selected, the voltage across the load will be

$$\frac{100,000}{100,000 + 50} = 99.95\%$$

of the open circuit voltage. With the 50 Ohm source impedance in use, the voltage across the load will differ from the open-circuit voltage by no more than 0.1 dB if the load is approximately 5,000 Ohms or higher. For a 10,000 Ohm load (typical of bridging inputs on many professional audio devices), the loading of the 50 Ohm source will produce approximately an 0.05 dB error.

Vpp (generator only)

This is the peak-to-peak open-circuit value (emf) to which the generator is set. As an open circuit value, it is independent of generator source impedance and does not use the load resistance information.

Volts (analyzer)

The principal or READING voltmeter (in the analyzer module) has five selectable detectors: true rms, average responding rms calibrated, quasi-peak (Q-Pk) complying with CCIR Recommendation 468-3, true peak, and scaled true peak (S-Pk). The S-Pk detector is the same as the true peak detector but with a 0.707 (-3.01 dB) scale factor to read sinewave equivalent peak. The values displayed will thus vary with the detector selected and with the signal waveform being measured. When the distortion measurement module is also present, a second voltmeter called LEVEL is added which continually monitors the input signal before any filtering; the LEVEL voltmeter detector is true rms.

dBm (generator and analyzer)

dBm is decibels referred to a power level of one milliwatt in the selected impedance.

Generator dBm

The power units available for the generator are dBm & Watts; Watts units are rarely used as the generator amplitude unit. Neither the generator nor computer can directly measure or control generator output power, output current, or external load resistance. The computer and software have control only of generator open-circuit voltage. Therefore, in order for a value in dBm or Watts entered by the user into the generator AMPLITUDE field to be valid, the operator must first determine the value of the external load and enter that value into the W/dBm REF field near the bottom of the generator panel. The computer, knowing the value of source impedance presently selected on the generator, then uses the W/dBm REF field value to compute what the open-circuit voltage must be set to in order to produce a voltage across the load resulting in the specified power in the load. If the source impedance is changed to another available value, the computer recalculates the equation and re-sets the open-circuit voltage so as to maintain the specified power in the load. For example, setting 0 dBm into a 600 Ohm load (0.7746 Volts across the load) from a 50 Ohm source load will produce a generator open-circuit voltage of

$$0.839V = 0.7746V \frac{600 + 50}{600}$$

Changing the source impedance to 600 Ohms causes the open-circuit voltage to go to

$$1.549 V = 0.7746 V \frac{600 + 600}{600}$$

In dBm mode for generator AMPLITUDE, the computer software assumes that both generator output connectors A and B are loaded with the external value specified in the W/dBm REF field if the A&B or A&-B generator output selections are made. It assumes only one output is loaded if either A or B output selections are made. Violating these assumptions will result in an amplitude calibration error.

Note that the GEN-MONITOR internal connection from generator to analyzer only loads the generator output with 100,000 Ohms. The selectable 100k/600/150 Ohm input terminations on the analyzer affect only the front-panel input connectors but not the GEN-MONITOR path.

Analyzer dBm

To compute measured power, the system must know the value of resistance across which the analyzer is measuring. The user must enter this value into the "dBm/W REF" field near the bottom of the ANALYZER panel. The analyzer then measures the voltage, performs a power conversion (square of the voltage, divided by the resistance) and converts the result into dB relative to one milliwatt.

dBu (generator and analyzer)

dBu is decibels referred to a voltage of 0.7746 Volts; it does not imply any value of circuit impedance or power. The value of 0.7746 volts is the voltage across a 600 ohm resistor when exactly one milliwatt is being dissipated in the resistor. Thus, dBu as measured by the analyzer is numerically equal to dBm when measuring in a 600 ohm circuit. *Virtually all audio voltmeters and distortion analyzers used throughout the history of audio measurements (including those still being manufactured today) actually measure dBu even though their mode selection and meter scale indication may indicate dBm, since they have no knowledge of the circuit impedance and thus the actual power.* On the generator, dBu is an open circuit value, is independent of generator source impedance, and does not use the load resistance information.

Modern broadcasting and pro audio equipment normally has output impedances much lower than input impedances. Output impedance values from zero up to 50 Ohms are typical, and input impedances of 10 kilohms are typical. Such equipment, connected together, transfers negligible power due to the large impedance mis-match. However, nearly all the source voltage is transferred. As noted earlier, a 10 kilohm load reduces the open-circuit voltage from a 50 Ohm source by only 0.5%, or 0.05 dB. Thus, modern systems typically operate on a

voltage transfer basis and the dBm, as a power unit, is not appropriate. The proper unit for voltage-based systems is the dBu. Older audio meters calibrated in “dBm” are really dBu meters. A good general rule when working with modern audio equipment, unless you know it to be terminated in 600 Ohms, is to interpret the manufacturer’s “dBm” as “dBu”. Even if in doubt about the actual termination value, you won’t go very far astray in using dBu with the System One generator’s 50 Ohms source; 600 Ohms loads a 50 Ohm source by about 0.7 dB.

dBV (generator and analyzer)

dBV is decibels referred to a voltage of 1.0000 Volts. On the generator, it is an open circuit value independent of generator source impedance and does not use the load resistance information.

dBr Relative dB (generator and analyzer)

Both the generator and the analyzer offer dBr as one of the unit choices. dBr stands for dB relative; the zero dB reference value for the dBr unit on each panel is the “dBr REF” field near the bottom of the panel.

While in panel mode, the dBr REF value may be changed in three fashions; one is to move the cursor to the dBr REF field and enter a new number (and units, if desired) from the keyboard. A second method, if it is desired to store the present value of generator amplitude as the new generator dBr REF, is to press the <F3> function key. Similarly, the amplitude presently being measured by the analyzer can be stored as the analyzer dBr reference by pressing the <F4> function key. A third technique is to move the cursor to the generator or analyzer dBr REF field, as desired, and press either the <+> or key. If the amplitude is displayed in dBr, the reading will go to 0.00 dB.

This “remember the reference” capability is particularly useful on the analyzer to preserve the present reading as the reference for a frequency response, signal-to-noise ratio, common-mode rejection ratio, or gain measurement. On the generator, it may be used after experimentally increasing the gen-

erator amplitude for some measured phenomenon (for example, onset of clipping or 3% distortion point of a tape recorder). It is then simple to make succeeding measurements at values such as -3 dB or -20 dB from that level.

Note that the power-up default value of the dBr REF on both generator and analyzer is 387.3 millivolts, the voltage across a 150 Ohm resistor when one milliwatt is being dissipated. Thus, dBr is equal to dBm in 150 Ohms when the default dBr REF is used and System One is connected to a 150 Ohm circuit.

The dBr unit may also be selected for distortion measurements, as one of the absolute units. Two example applications are in digital systems. In such systems, the theoretical minimum distortion and noise value is known or may be computed from knowledge of the number of bits and full-scale output level. If this value is entered for the dBr REF and the READING unit in THD+N mode is selected as dBr, the display will be in terms of dB of “excess distortion and noise” above the theoretical floor. It is also possible to enter the full-scale output level as the dBr REF (for example, by pressing <F4> while playing a 0 dB track on a compact test disc) and display quantization distortion in dB below full-scale output.

dB (analyzer only)

The ratio unit dB is available in distortion-measurement modes (THD+N, SMPTE, CCIF, DIM) and in the CROSSTALK and 2-CHANNEL modes of A-version hardware. In THD+N mode, the dB unit expresses the value of the distortion products relative to the distorted input signal amplitude. In SMPTE and DIM modes, dB expresses distortion relative to the amplitude of the high-frequency tone. In CCIF mode, dB expresses distortion relative to the amplitude of either of the two close-spaced tones.

With A-version hardware in CROSSTALK mode, dB expresses the signal in the non-driven channel relative to the currently-measured signal amplitude in the driven channel. In 2-CHANNEL

mode, the dB unit expresses the ratio of the signal in the channel selected at the top of the ANALYZER panel to the signal in the alternate channel.

PPM (analyzer only)

The ratio unit PPM (parts per million) is available in distortion functions plus 2-CHANNEL and CROSSTALK functions of A-version hardware. It is similar to %, dB, and X/Y, but expresses the selected quantity in parts per million of the reference quantity. For example, 0.0037% equals 37 ppm.

X/Y (analyzer only)

The ratio unit X/Y (dimensionless) is available in all distortion functions plus in the 2-CHANNEL and CROSSTALK functions of A-version hardware. In the distortion functions, it is similar to % and dB but expresses the distortion as a ratio of amplitudes. In 2-CHANNEL and CROSSTALK functions, it expresses the ratio of amplitudes of the selected channel to the alternate channel. For example, 3% equals a ratio of 0.03.

W (generator and analyzer)

The W (Watts) units in the generator AMPLITUDE field and in the analyzer units fields, just as the dBm units, require that System One knows what external resistance it is connected across. The dBm/W REF fields at the bottom of both GENERATOR and ANALYZER panels permit you to enter any numeric value of external resistance. Operation of generator and analyzer in Watts units is identical to that described above under dBm except that the result of the power computation is expressed in Watts with no decibel conversion made.

8.2. Relative vs Absolute Distortion Units

THD+N may be expressed in either relative (% , dB, PPM, X/Y) or absolute units. The relative units express the amplitude of the distortion products and noise with reference to the input (distorted) signal.

The absolute units (Volts, dBm, etc.) directly express the absolute amplitude of the distortion products.

While either relative or absolute units may be freely selected on the ANALYZER panel, the choice of units on the SWEEP (F9) DEFINITION panel is constrained by the data structure of System One's files. *If a relative unit is selected on the ANALYZER panel, only relative units may be selected on the SWEEP panel and ultimately saved.* In this case, the displayed and saved data results from computations involving two measurements: signal amplitude from the LEVEL voltmeter and distortion product measurements following the notch filter, from the READING voltmeter. It is thus not possible to change to absolute units and re-display the same test data following a test, since only the computed ratios were saved. Similarly, *if an absolute unit is selected on the ANALYZER panel, only absolute units may be selected on the SWEEP panel.* It is then not possible to change to a relative unit, since the signal amplitude was not measured and saved.

Only relative units (% , dB, PPM, X/Y) are available in the three intermodulation distortion modes. Absolute units are not meaningful due to the definitions of the forms of intermodulation distortion.

8.3. Relative Frequency Units

A reference frequency may be entered into the Freq REF field near the bottoms of the GENERATOR and ANALYZER panels. This reference frequency may be typed in from the keyboard. The present generator frequency may be automatically transferred into the generator reference frequency field by the <Alt><F3> keystroke. On the analyzer, the frequency presently being measured by the frequency counter may be placed into the field by pressing <Alt><F4>. In addition to the absolute frequency units of Hz, a number of units relative to this reference frequency may be selected for the FREQUENCY setting field of the GENERATOR panel or the FREQUENCY display on the ANA-

LYZER panel, and as the displayed units for graphs and tables defined on the SWEEP (F9) DEFINITION panel.

Δ %

This unit causes the difference between the setting or measured frequency and the reference frequency to be displayed as percentage deviation from the reference frequency. For example, with a reference frequency of 3.15 kHz (common for tape speed and wow and flutter measurements), a measured frequency of 3.1185 kHz will display as -1.0% (speed 1% slow) when delta % units are selected.

Δ Hz

This unit displays the difference between the setting or measured frequency and the reference frequency. For example, with a reference frequency of 1.000 kHz, a measured frequency of 1.010 kHz will display as +10 Hz and a measured frequency of 997 Hz will display as -3 Hz.

Δ PPM

This unit displays the difference between the setting or measured frequency and the reference frequency to be displayed as deviation from the reference frequency in parts per million. For example, with a reference frequency of 1.000 kHz, a measured frequency of 1.00001 kHz will display as +10 PPM (1 PPM equals 0.0001%).

%Hz

This unit displays the setting or measured frequency as a percentage of the reference frequency. For example, with a reference frequency of 1.000 kHz, a measured frequency of 500 Hz will display as 50% and a measured frequency of 1.100 kHz will display as 110%.

OCTS

This unit displays the difference between the setting or measured frequency and the reference frequency in octaves, where an octave is a two-to-one ratio of frequencies. For example, with a reference

frequency of 1.000 kHz, a measured frequency of 500 Hz will display as -1.000 (one octave below the reference) and a measured frequency of 4000 Hz will display as +2.000 (two octaves above the reference).

DECS

This unit displays the difference between the setting or measured frequency and the reference frequency in decades, where a decade is a ten-to-one ratio of frequencies. For example, with a reference frequency of 1.000 kHz, a measured frequency of 100 Hz will display as -1.000 (one decade below the reference) and a measured frequency of 100 kHz will display as +2.000 (two decades above the reference).

CENTS

This unit displays the difference between the setting or measured frequency and the reference frequency in cents, where a cent is 1/100 of a half-step on a musical scale. For example, if the reference frequency is 440 Hz (the note A above middle C on a piano), a measured frequency of 440.262 Hz will display as +1.0 CENTS.

F/R

This unit displays the ratio (unitless) of the setting or measured frequency to the reference frequency.

8.4. Phase and Polarity Units

Phase may be displayed on the ANALYZER panel, on bargraphs, or on line graphs in four units; deg, deg1, deg2, deg3, and radians. Deg, deg1, deg2, and deg3 are all degrees, but with different full scale range characteristics. Polarity testing results are also displayed on the PHASE line with the POL unit.

deg

Degrees are displayed with the panel or bargraph display range being automatically selected as either +/-180 degrees or 0 to 360 degrees, depending on the value being displayed. When sweeping frequency and displaying on a line graph, integral multiples of 360 degrees are added or subtracted as necessary to make each new measurement plot closest to the preceding plotted point. This mode produces continuous graphs even over thousands of degrees, rather than the abrupt transitions between maximum and minimum typical of most graphic plots of phase.

deg1

Degrees are displayed on the panel or bargraph or plotted on line graphs with a fixed +/-180 degree range. Values exceeding the end of the range will make an abrupt transition to the opposite end of the range. Readings at 180 degrees will be inaccurate and unstable.

deg2

Degrees are displayed on the panel or bargraph or plotted on line graphs with a fixed +270/-90 degree range. Values exceeding the end of the range will make an abrupt transition to the opposite end of the range. Readings at +270 or -90 degrees will be inaccurate and unstable.

deg3

Degrees are displayed on a fixed 0 to +360 degree range. Values exceeding the end of the range will make an abrupt transition to the opposite end of the range. Readings at 360 degrees or 0 degrees will be unstable.

POL

The POL unit indicates an in-phase condition by displaying a 0 and an out-of-phase condition by displaying +180. The signal required for polarity testing is a low-duty-cycle sinewave burst from the BUR-GEN module.

8.5. Sine Burst Units

When the BUR-GEN module is installed on the generator and SINE BURST, SINE TRIG, or SINE GATE selected as the waveform, several units are available to control the duration of a burst and the interval between the beginning of successive bursts. **CYCLES** refers to complete cycles of the generator frequency. The **secB** unit refers to seconds of burst duration. **%ON** is the duty factor of the burst: burst duration divided by burst period. **Bps** is bursts per second, the repetition rate of the train of bursts. See the BUR-GEN chapter for more details on these units and their usage.

8.6. DSP Units

Units of display with the DSP module are totally dependent upon the particular DSP program in use. See the documentation provided with each DSP program for an explanation of these units.

9. GENERATOR PANEL

See the Generator and Analyzer Hardware chapter beginning on page 32-1 for description and a block diagram of the analog generator. The GENERATOR panel is reproduced in Figure 9-1. The fields can be grouped into five functional areas: waveform selection, amplitude control, frequency control, output configuration control, and (if the BUR-GEN module is present) tone burst control.

9.1. Waveform Selection

The WAVEFORM line, consisting of the main waveform field and, for certain waveforms, the waveform modifier field, permits selection of the generator output waveform. The waveform field selections are SINE, EQSINE, SMPTE, CCIF, DIM, SQUARE, PSEUDO, and RANDOM. EQSINE is a

sinewave whose amplitude is adjusted as a function of the selected frequency according to an attached equalization file. See the EQUALIZATION chapter (page 23-1) for a complete discussion of generator equalization curve capability. SMPTE, CCIF, and DIM are all intermodulation distortion test signals available if the intermodulation signal generator option has been installed onto the generator module. See the INTERMODULATION DISTORTION chapter (page 16-1) for details. SQUARE, PSEUDO, RANDOM, and the BURST, TRIG, and GATE waveform modifier selections of the SINE waveform are signals available if the BUR-GEN option has been installed onto the generator module. See the BURST-SQUAREWAVE-NOISE GENERATOR chapter (page 20-1) for full details. The

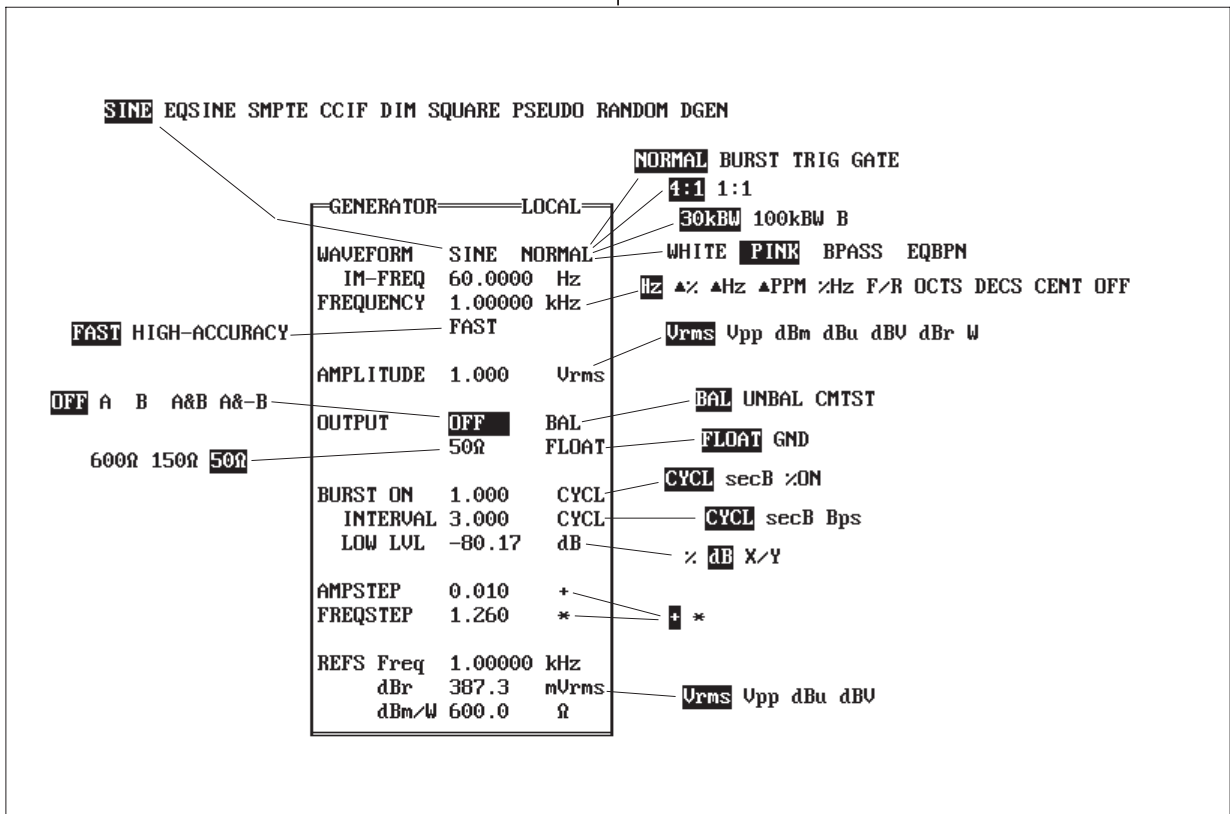

Figure 9-1 GENERATOR Panel

DGEN selection, of the DSP module is installed and if the currently-loaded .DSP program includes signal generation capability, permits the output of the DSP generator to be routed via D/A converter through the analog generator power amplifier, transformer, and attenuators.

The table below shows the waveform modifier selections available under each of the waveforms.

WAVE-FORM	WAVEFORM MODIFIER	COMMENTS
SINE	NORMAL	STANDARD
	BURST	BUR OPT
	TRIG	BUR OPT
	GATE	BUR OPT
EQSINE		STANDARD
SMPTE	4:1	IMD OPT
	1:1	IMD OPT
CCIF		IMD OPT
	30 kW	IMD OPT
	100 kW	IMD OPT
DIM	B	IMD OPT
		BUR OPT
SQUARE PSEUDO	WHITE	BUR OPT
	PINK	BUR OPT
	BPASS	BUR OPT
	EQBPN	BUR OPT
		BUR OPT
RANDOM	WHITE	BUR OPT
	PINK	BUR OPT
	BPASS	BUR OPT
	EQBPN	BUR OPT
DGEN		DSP OPT

9.2. Amplitude Control

The amplitude control and indication fields consist of:

- the **AMPLITUDE** line (numeric field and units)
- the **POST-EQ** line (numeric field; same units as **AMPLITUDE**)
- the **AMPSTEP** line (numeric field and additive/multiplicative choice)

- the **dBr REF** line (numeric entry or capture of present value by <F3> function key or /<+> key, and units)
- the **dBm/W REF** field (numeric entry).

The **AMPLITUDE** numeric entry field can either have digits entered directly from the keyboard or it can be incremented/decremented by use of the **AMPSTEP** value and the <+> and keys. In direct digit entry, System One understands the common prefixes of k for kilo, m for milli, u for micro, and n for nano. It will also accept entries in scientific notation, such as 1E1 for 10 volts. If an amplitude outside the range of the generator is entered, the system will sound a warning signal and display a “Conflict with Maximum (or Minimum) Amplitude” warning at the lower left of the panel. The actual generator amplitude will remain unchanged.

The amplitude units can be selected by use of the “choice” cursor, controlled by the space bar or <+> and keys. The <Enter> key then actually makes the selection. See the **UNITS** chapter for definitions of the various units available. When units are changed, the generator open-circuit voltage will not change; open-circuit amplitude will simply be re-stated in the various units.

The **POST-EQ** field is visible only when **EQSINE** waveform is selected. **POST-EQ** units are always the same as **AMPLITUDE** units. **POST-EQ** is a display-only field. It shows the actual amplitude the generator is asked to furnish, which is a function of both the value set in the **AMPLITUDE** field and of the value of an attached equalization file at the particular frequency at which the generator is set. If no equalization file is attached, a value of 1.00 is assumed for equalization at all frequencies. See the **EQUALIZATION** chapter.

AMPSTEP is used to select the size of change when manually incrementing and decrementing amplitude with the <+> and keys in panel or bar-graph mode. Any desired value can be entered into the **AMPSTEP** numeric field. If the arithmetic operator to the right of the number is +, the <+> and keys will respectively add or subtract the **AMPSTEP** numeric value to (from) the **AMPLI-**

TUDE value each time they are operated. This will only occur while the cursor is located on either the AMPLITUDE numeric field or the AMPSTEP numeric field, or during bargraph (F2) mode with GEN AMPL selected as SOURCE-1. The units of AMPSTEP are always the same as the units selected for AMPLITUDE. Thus, an AMPSTEP of 0.20 will produce 0.2 dB increments if the AMPLITUDE units are dBm and 200 millivolt increments if the AMPLITUDE units are Volts rms.

If the arithmetic operator is *, the <+> key will multiply the AMPLITUDE value by the AMPSTEP value (and the key will divide by the AMPSTEP value) each time it is operated while the cursor is located on either the AMPLITUDE or AMPSTEP numeric fields. For example, an AMPSTEP of 1.050 * will cause the amplitude to increase to 1.05 times its previous value each time the <+> key is pressed, and to decrease to 0.95238 times (1.0/1.05) the previous value each time the key is pressed. This permits manually-controlled logarithmic amplitude sequences if the AMPLITUDE units are Vrms or Vpp.

The dBr REF line lets the operator tell the system what value of amplitude to use as the zero dB reference for the generator dBr (dB relative) units. The power-up default value of dBr REF is 387.3 millivolts, the voltage across a 150 Ohm resistor when one milliwatt is being dissipated in the resistor. Any new value may be entered into the numeric field from the keyboard, and the units may be selected in the usual select and <Enter> fashion.

It is frequently convenient to make the present value of the generator amplitude become the reference value for dBr. The generator amplitude (POST-EQ value if EQSINE mode is in use) can be transferred to the dBr REF field at any time by pressing the <F3> function key, or by moving the cursor to the dBr REF numeric field and pressing the <+> or key. The value transferred will immediately display in the dBr REF field, and if the AMPLITUDE units are dBr the display will be seen to be 0.00 dBr.

The dBm/W REF field is used for the operator to inform the system of the value of external load resistance connected across the generator output. Any value may be entered from the keyboard. This value of resistance is then used by the system, along with the known value of generator source impedance, to compute what value of emf the generator should be set to in order to deliver the specified value of power in dBm or Watts to the load. ***When the DUA-GEN option is present and both outputs are turned on (A&B or A&-B), the system assumes that both outputs are loaded with the value of resistance shown in the dBm/W REF field.***

If either of the power units (dBm or W) is selected and a change in generator source impedance or specified load resistance is then made, the system will re-calculate and re-set the generator emf to maintain the previously-specified power level under the new conditions.

Since the generator emf range is finite (approximately 10 uV to 26.6 Vrms balanced, 10 uV to 13.3 Vrms unbalanced or common mode test configuration), not all values of power can be delivered to any arbitrary value of load resistance. An error message will result if the generator is unable to deliver the requested power to the specified load from the presently selected source impedance. The generator current delivery capability is also finite (rated 115 mA peak balanced, 230 mA peak unbalanced). If the system is asked to deliver an amount of power into a low load impedance which would exceed the current rating, an overload indication will appear.

9.3. Frequency Control

The frequency control fields consist of:

- the FREQUENCY line
- the FAST/HIGH ACCURACY line
- the FREQSTEP line
- the IM-FREQ line (SMPTE and CCIF modes only)
- the REFS Freq line.

FREQUENCY may be set and changed by direct numeric entry into the field to the right of the FREQUENCY label; the system understands k as kilo and will also accept scientific notation such as 3.5e3 for 3500 Hz. Frequency can also be changed in an increment-decrement fashion by use of the FREQSTEP capability. If a frequency outside the range of the generator is entered, the system will sound a warning signal and display a “Conflict with Maximum (or Minimum) Frequency” warning, leaving the actual generator frequency unchanged.

Frequency may be expressed absolutely, in Hz and kHz, or in a number of relative frequency units. The reference value for the relative frequency units may be entered in the REFS Freq field near the bottom of the panel. Any value may be typed in, or the <Alt><F3> keystroke may be used to automatically transfer the present value from the FREQUENCY field into the REFS Freq field.

Generator frequency can be controlled in two modes, each with its own trade-offs. FAST mode will be used for the large majority of audio testing. FAST mode produces worst-case frequency resolution of 0.25% or better and accuracy of 0.5%, which is adequate for most applications. It yields frequency settling times of about 10 milliseconds. HIGH ACCURACY mode includes a two-step frequency calibration each time the generator frequency is changed, using a quartz-based counter on the generator module as the calibration source. The result is frequency resolution of 0.005% and accuracy of 0.03%, with a calibration cycle time ranging from less than 150 milliseconds at frequencies above 50 Hz to about 3/4 second at 10 Hz. Even when FAST mode is selected, the calibration cycle of HIGH-ACCURACY mode may be invoked by pressing the <Enter> key while the cursor is on the frequency numeric entry field. HIGH-ACCURACY mode cannot pull the generator frequency within the 0.03% specification if the generator, in the FAST mode, has drifted outside its rated 0.5% range.

FREQSTEP functions similarly to AMPSTEP. Any value may be entered into the numeric field next to the FREQSTEP label, and either + (additive) or * (multiplicative) may be selected as the arithmetic operator in the field to the right of the step

size. The default value (value used when System One software is first loaded) is 1.25992 * (multiplicative), which is the 1/3 octave multiplier value (display rounds to 1.260). Thus, if the cursor is placed on either the FREQSTEP numeric field or the FREQUENCY numeric field, or in bargraph mode, the generator frequency will be moved in three logarithmically equal steps over a 2:1 frequency range (one octave) when the <+> key is pressed three times. The key similarly decreases the frequency in steps. For steps of a constant number of Hz, select + as the arithmetic operator, enter the step size into the FREQSTEP numeric field, and use the <+> and keys. When a relative frequency unit is selected at the GENERATOR FREQUENCY field, FREQSTEP will control operation in the units selected. Thus, another way to obtain 1/3 octave steps is to choose OCTS as the unit, .33333 + as the FREQSTEP increment size and arithmetic operator, and use the <+> and keys.

System One's intermodulation distortion test signals consist of two frequencies. In the SMPTE modes (which also generate signals for DIN imd testing), the lower-frequency tone is selected via the IM-FREQ line, which will be visible only when the SMPTE or CCIF waveforms are selected. In the CCIF twin-tone mode, the spacing between the two tones is selected on the IM-FREQ line. The <+> and keys allow selection of any of the available frequencies, or a frequency may be entered with the digit keys and the software will select and display the nearest available intermodulation frequency. The IM-FREQ line has no effect on the DIM modes, where the squarewave frequency selection is made automatically when DIM 30kBW, DIM 100kBW, or DIM B is selected as the waveform. See the INTERMODULATION DISTORTION chapter beginning on page 16-1 for more details.

9.4. Output Section Control

The output section control area consists of four fields on the GENERATOR panel:

- channel on/off and phase (OFF, A, B, A&B, A&-B)

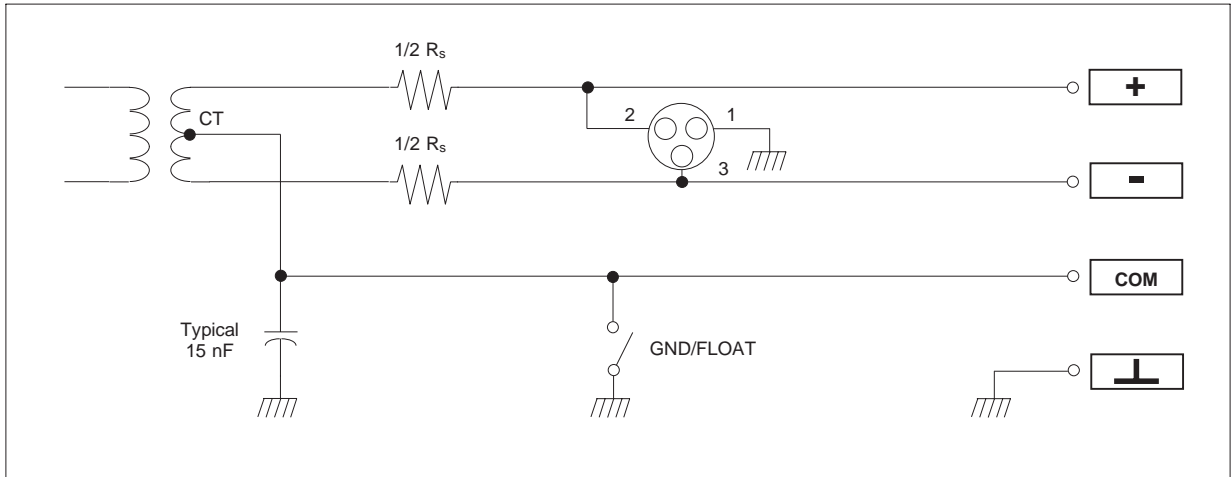

Figure 9-2 Balanced Mode Output Configuration

- output configuration (BALanced, UNBALanced, CMTST [common mode test])
- source impedance (600, 150, or 50 Ohms balanced/common mode test, 600 or 25 Ohms unbalanced)
- FLOAT/GND selection.
- OFF/A/B/A&B/A&-B

Both outputs may be off (OFF); output A only may be selected (A); output B only may be selected (B); both outputs A and B may be on (A&B); or both A and B may be on, but with output B inverted 180 degrees in phase relative to output A (A&-B).

This latter mode is used during testing of multiplex stereo broadcast systems. **The OFF condition will produce lower residual signal and noise at both outputs than will be present at the non-selected output in either the A mode or B mode.** When either or both outputs are off or not selected, they are back-terminated in a resistance equal to the selected source impedance. This permits noise and crosstalk measurements to be made with no necessity of disconnecting cables or connecting termination resistors to the input of the device under test. **In both A&B and A&-B modes with either dBm or Watts selected as the generator amplitude units, the system assumes that both outputs are connected to load resistances of the value shown in the dBm/W**

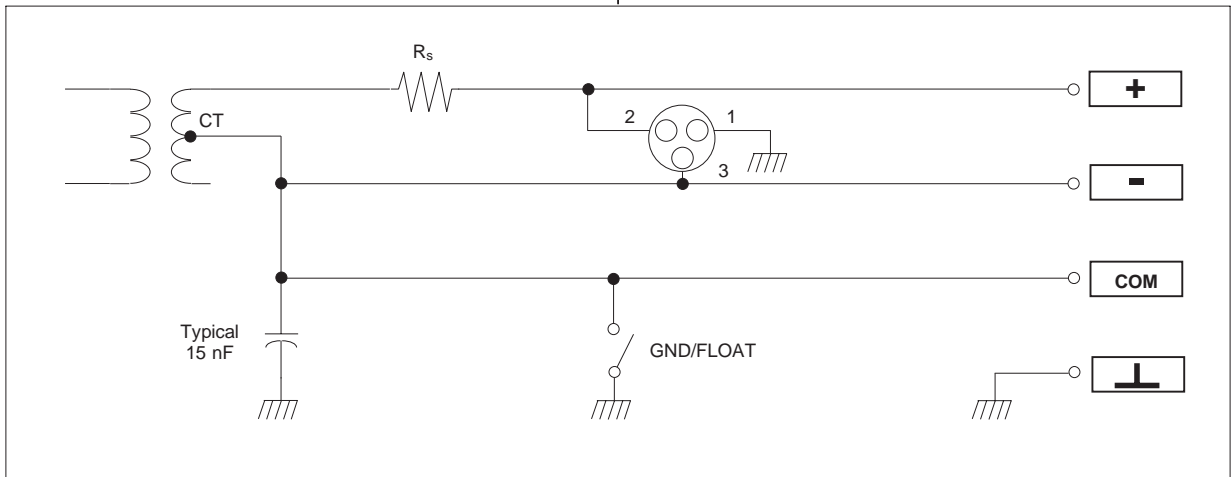

Figure 9-3 Unbalanced Mode Output Configuration

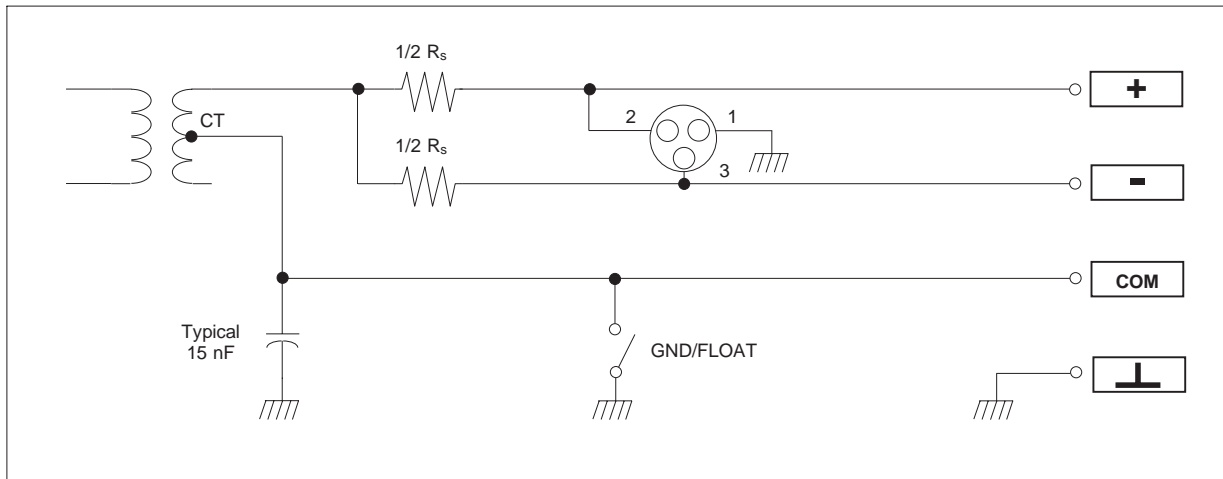

Figure 9-4 Common Mode Test (CMTST) Configuration

REF field. For these reasons, use only the OFF and A modes when the DUA-GEN option is not present or the second channel is not in use.

9.4.1. Bal/Unbal/Cmtst

Pin 1 of the XLR and the sleeve of the phone jack are connected to chassis ground at all times.

BALANCED mode (see Figure 9-2) provides a balanced signal from the generator output transformer. Pin 2 of the XLR connector and the (+) banana jack or the tip of the 3-conductor 1/4" phone jack are connected to the end of the transformer secondary winding which is in phase with the MONITOR jack on the generator auxiliary connector panel. Pin 3 of the XLR and the (-) banana jack or the ring of the phone jack connect to the opposite end of the transformer secondary. The transformer secondary center-tap connects to the COM banana jack on the generator output connector panel.

UNBALANCED mode (Figure 9-3) connects the high side of the transformer secondary to pin 2 of the XLR and the phone jack tip or (+) banana jack. The transformer secondary low side connects to pin 3 of the XLR, the ring of the phone jack or (-) banana jack, and to the COM banana jack. Maximum output amplitude in the UNBAL mode is one-half the maximum available in BAL mode, but the peak current available is twice that in BAL mode. At gen-

erator frequencies below 20 kHz, the generator may be used in BALANCED mode with one end of the output grounded if the highest output levels (above 13.3 Volts) are needed in an unbalanced system.

Note that adapter cables from the XLR connectors to typical unbalanced connectors such as RCA (Cinch) phono plugs or 1/4" or miniature phone plugs must be wired from pins 2 and 3 of the XLR connector. Pin 2 of the XLR must be connected to the center conductor of the plug and pin 3 of the XLR must be connected to the shell of the phono plug or sleeve of the phone plug. A separate ground wire from the ground connector on the GENERATOR panel to chassis ground on the device under test is also recommended. Using GROUND mode is likely to add noise through ground loops. When a stereo device is to be driven, the A and B channel cables should be twisted together or otherwise tightly dressed together to minimize hum coupling. Hum is a potential problem in this configuration since a loop exists, created by the fact that the signal common of both channels is normally connected together at the device input and also inside the GENERATOR output.

CMTST (common mode test) mode (Figure 9-4) permits the measurement of the common-mode rejection ratio (cmrr) of balanced-input devices without any cable changes from the normal connections used for all other tests. CMTST mode connects the transformer secondary high side (in unbalanced configu-

ration) to the center-tap of a pair of precision matched resistors between pins 2 and 3 (+ and - banana jacks, or tip and ring of the phone jack). The series resistance of the pair equals the selected generator source resistance. The transformer low side must be connected to ground at signal frequencies; for the majority of common mode testing, this is done by selecting GND at the FLOAT/GND field on the GENERATOR panel. For cases such as measuring the cmrr of microphone inputs which have a phantom power dc voltage present, it may be preferable to select FLOAT and to connect a large capacitor between COMMON and GROUND connectors on the generator connector panel. This will prevent current flow from the phantom power supply through the secondary of the generator output transformer. The CMTST FLOAT connection could also permit the introduction of some other common mode signal in addition to the generator output, by connecting the other signal source between generator COMMON and GROUND. Since CMTST mode uses half the transformer secondary, as does UNBAL mode, the maximum amplitude available is half that available in BAL mode.

9.4.2. 600/150/50

The source impedance selections available from generator are 600 Ohms, 150 Ohms, and 50 Ohms in BALANCED and CMTST modes. In UNBALANCED mode, 150 Ohms is not available and the lowest impedance selection changes from 50 to 25 Ohms. If the European broadcast option version of hardware has been installed and the European mode of the software has been invoked at start-up, the generator impedance choices will be 600 Ohms, 200 Ohms, and less than 40 Ohms.

9.4.3. Float/Gnd

FLOAT mode opens all connections from System One's chassis ground to any point on the generator output transformer secondary. GND mode connects the COM banana jack (transformer center tap when BALANCED, transformer low side when UNBALANCED) to chassis ground through a one ampere fuse located on the generator module circuit board.

GND mode is not normally recommended when driving unbalanced devices due to the probability of ground loops. FLOAT mode may be used in conjunction with a separate conductor connected between the generator COMMON connector and a ground on the device under test, for optimum noise rejection.

9.5. Tone Burst Control

The tone burst control section of the panel consists of the three lines labeled BURST ON, INTERVAL, and LOW LVL. These lines will not be visible (except by placing the cursor on them) unless SINE BURST, SINE TRIG, or SINE GATE is selected at the WAVEFORM line. SINE TRIG will only cause the BURST ON and LOW LVL lines to appear; SINE GATE will only cause the LOW LVL line to be visible.

The BURST ON field controls the duration of the higher-amplitude portion of a repetitive internally-generated tone burst or an externally-triggered burst. The INTERVAL field controls the time from the start of one burst to the start of the next during internally-generated repetitive burst operation. The LOW LVL field controls the amount by which the lower amplitude portions (between bursts) will be below the amplitude set in the AMPLITUDE field near the top of the panel. The values for each of these parameters may be entered and displayed in several units.

For more information on tone burst operation, see the BURST-SQUAREWAVE-NOISE GENERATOR chapter starting on page 20-1.

9.6. Interactions

The available range of amplitude (POST-EQ amplitude in EQSINE mode) and frequency are interdependent with one another and with certain parameters of the output configuration and the specified value of load resistance (dBm/W REF). For example, the maximum value of open-circuit voltage is not available over the entire frequency range; the maximum open circuit voltage available in UNBAL

or CMTST modes is half that available in BAL mode; the maximum amplitude available in square-wave and noise modes is half that in sinewave modes; the maximum available power (in dBm or Watts units) depends not only on the frequency and balanced-unbalanced configuration, but on the generator source impedance and the specified load resistance.

When making changes to AMPLITUDE, FREQUENCY, or one of the interdependent configuration or impedance values, you may obtain the “Conflict with Maximum Amplitude” or “Conflict with Maximum Frequency” warnings. It may be that the combination of conditions you are attempting to achieve is available, but that you are temporarily requesting an unavailable combination due to the sequence in which you are making the changes; a different order of change can then achieve your goal. For example, assume that you are operating at 10 Vrms at 15 Hz and wish to change to 25 Vrms at 30 Hz. Both are available combinations, but if you attempt to set 25 Vrms while still at 15 Hz, you will get a warning and no change. Changing the frequency first will then permit the amplitude to be increased to the desired level.

10. ANALYZER PANEL

The ANALYZER panel, reproduced in Figure 10-1, controls the entire audio analyzer (analog measurements) section consisting of the LVF Level and Frequency Measurement Module, the PHA-LVF Dual Input and Phase Measurement Option (if present), the DIS Distortion Measurement Module, the IMD-DIS Intermodulation Distortion Analyzer Option (if present), and the W&F-LVF Wow and Flutter Analyzer Option (if present). The choices available at each of the multiple-choice fields are also shown in the figure.

The analyzer includes four separate and independent meters. These are the PHASE meter, the FREQUENCY counter, the LEVEL meter, and the READING meter. Their readings are displayed near the top of the ANALYZER panel. The PHASE me-

ter always displays the phase difference between the signals present at the CHANNEL A and CHANNEL B inputs. The FREQUENCY counter always displays the frequency of the signal present at one of these inputs. The LEVEL voltmeter always displays the amplitude of the signal at one of these inputs.

The READING voltmeter is a flexible, multipurpose meter which can measure and display in any of ten different functions if all the available measurement options (IMD and W&F) are fitted; see below for a description of these ten functions. READING meter measurements are affected by choice of detectors, filters, and (often) the BP/BR tunable filter. Figure 10-2 shows the selection and display fields which affect only the READING meter measurements.

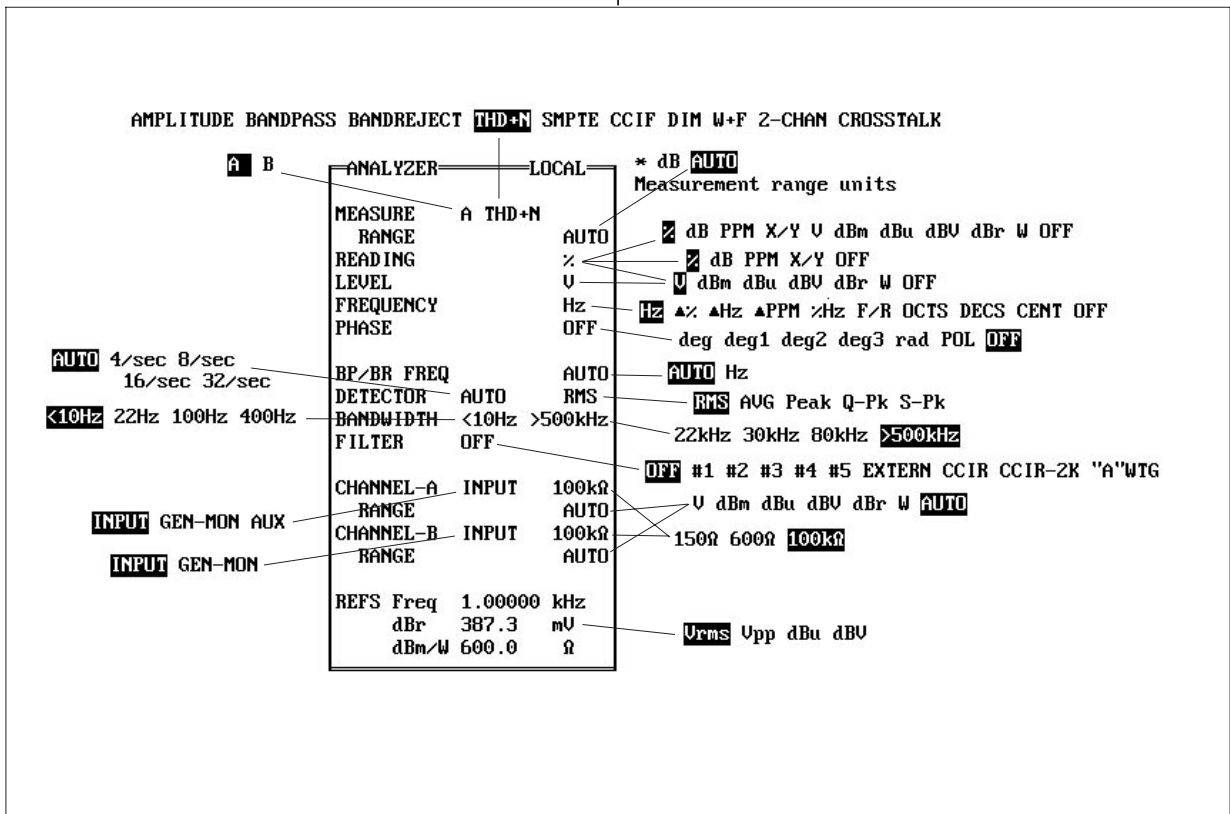

Figure 10-1 Analyzer Panel

Readings of the PHASE, FREQUENCY, and LEVEL meters are unaffected by any of these choices, since they measure signal prior to the circuit location of these filters. Figure 10-3 shows the analyzer selection fields which affect all meters. These include the channel selection (A vs B) field at the top of the panel, detector reading rate, and the input connector, termination and range control fields for both channels A and B. See the analyzer block diagram in the ANALYZER AND GENERATOR HARDWARE chapter for an understanding of the circuit location of these four meters.

10.1. Channel Selection and Principal Voltmeter Function

At the top of the panel on the MEASURE line, Channel A or Channel B may be selected if the PHA-LVF option is present. The principal (READING) voltmeter function is also selected on the

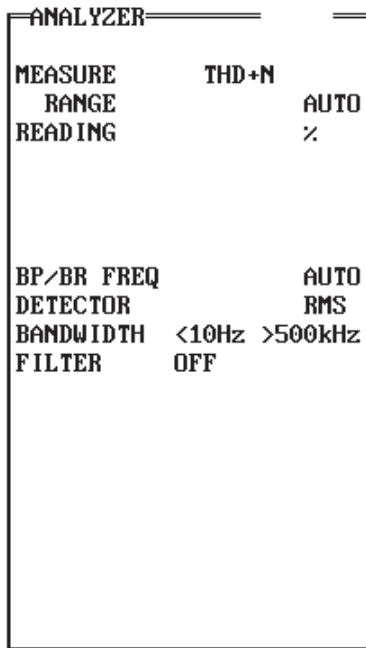

Figure 10-2 Analyzer Panel Fields Affecting Only the READING Meter

MEASURE line from AMPLITUDE, BANDPASS, BANDREJECT, THD+N, SMPTE, CCIF, or DIM, plus CROSSTALK or 2-CHANNEL (serial numbers SYS1-20300 and above only). With System One serial numbers below SYS1-20300, only one channel may be measured at any instant and a dashed line will be displayed instead of the CROSSTALK and 2-CHANNEL selections. Serial numbered units above SYS1-20300 permit amplitude measurements of both channels simultaneously in CROSSTALK and 2-CHANNEL functions.

- **AMPLITUDE** is a normal audio voltmeter mode.
- **BANDPASS** uses the tunable filter module two-stage filter in selective bandpass mode; the filter has a bandwidth of approximately 1/3 octave at the 3 dB points (Q of approximately 4.3), with skirt rejection slopes of 12 dB per octave. Center frequency tuning accu-

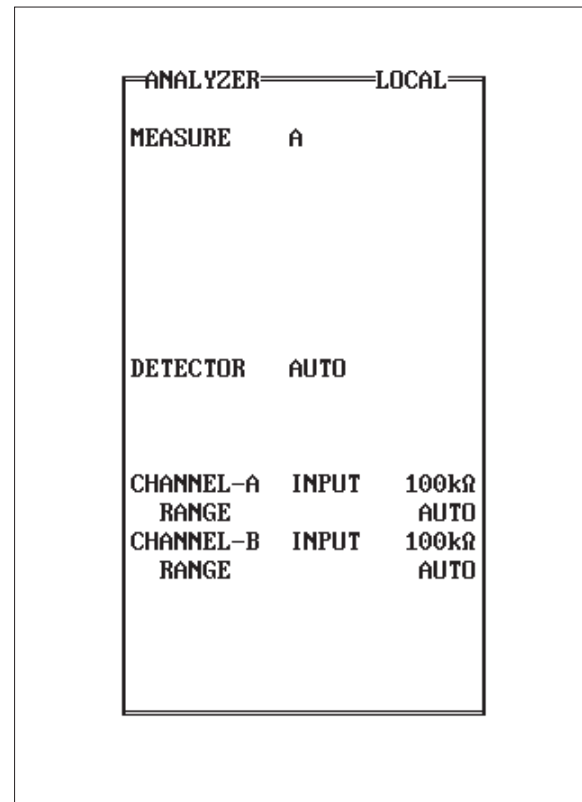

Figure 10-3 Analyzer Panel Fields Which Affect All Meters

racy is 3%. With serial numbers SYS1-20300 and above, the BANDPASS filter meets ANSI Class II 1/3 Octave specifications.

- **BANDREJECT** (notch) mode also uses the tunable two-stage filter, but in bandreject mode. BANDREJECT differs from THD+N in servo control of the notch. In THD+N function, servo circuits constantly operate to tune the notch frequency for maximum rejection of the signal fundamental frequency. In BANDREJECT mode, servos are disabled and the notch is tuned to the specified frequency with 3% accuracy.
- **THD+N** mode uses the tunable filter module two-stage notch filter, servo-controlled to automatically remove the fundamental component of the input signal so that the remaining harmonics plus noise may be measured. When any of the distortion ratio units (X/Y, %, dB, PPM) are used, the measurement of the READING meter through the notch filter is compared to the measurement of the LEVEL meter and the resulting computation is displayed in the READING field.
- **SMPTE**, **CCIF**, and **DIM** modes use the IMD-DIS option to measure intermodulation distortion products according to the selected standard. See the INTERMODULATION DISTORTION chapter for more details.
- **W+F** mode, if the wow and flutter option is present, measures to the IEC (DIN), NAB, and JIS standards plus wideband scrape flutter measurements. See the WOW AND FLUTTER chapter for more details.
- **CROSSTALK** function is available only with serial numbers SYS1-20300 and above. A dashed line displays instead of the CROSSTALK function choice if hardware below serial SYS1-20300 is connected. CROSSTALK function connects the principal voltmeter in bandpass mode to the channel selected at the top of the panel, to the left of MEASURE, and the LEVEL voltmeter and frequency counter to the alternate channel. The bandpass filter frequency is steered by the generator in generator-based sweeps and by the

counter in EXTERN sweeps. If a ratio unit (X/Y, %, dB, PPM) is selected, the number displayed on the READING line is the ratio of the selected (non-driven) channel to the alternate (driven) channel. If an absolute unit (V, dBm, dBu, dBV, dBr, and W) is selected, the READING field displays the measurement of the selected channel and the LEVEL field displays the measurement of the alternate channel.

- **2-CHANNEL** function is available only with hardware serial numbers SYS1-20300 and above. A dashed line displays instead of the 2-CHANNEL function choice if earlier hardware is connected. 2-CHANNEL function connects the principal voltmeter in amplitude mode to the channel selected at MEASURE, and the LEVEL voltmeter and frequency counter to the alternate channel. If one of the ratio units (X/Y, %, dB, PPM) is selected on the READING line, the number displayed on the READING line is the ratio of the selected channel (READING voltmeter) to the alternate channel (LEVEL voltmeter). With an absolute unit (V, dBm, dBu, dBV, dBr, and W) selected, the READING line displays amplitude of the selected channel and the LEVEL line displays amplitude of the alternate channel. *In bargraph display and 2-CHANNEL function (non-ratio unit selected at READING), the READING and LEVEL may be selected as desired for DATA-1 and DATA-2 to produce bargraphs of signal amplitude at both inputs simultaneously.*

The measurement in the function selected is displayed by the bright digits to the right of the READING label, and the units desired may be selected by the field at the right of the reading. Note that in THD+N, 2-CHANNEL, and CROSSTALK functions, both absolute units (V, dBm, dBu, dBV, dBr, and W) and ratio units (X/Y, %, dB, PPM) are available. The choice of units on the ANALYZER panel constrains the available unit selections on the SWEEP (F9) DEFINITION panel. Ratio units selected on the ANALYZER panel will permit only ratio units on the SWEEP (F9) DEFINITION panel;

absolute units on the ANALYZER panel permit only absolute units on the SWEEP TEST panel. See the UNITS chapter for more details.

10.2. Reading Meter Range Control

The range amplifier of the principal (READING) voltmeter is autoranging when AUTO is selected on the RANGE line immediately below the MEASURE line, near the top of the ANALYZER panel. Peak-sensitive detectors will automatically select the proper range for maximum resolution, depending upon the signal amplitude following the tunable filter module. See the analyzer block diagram in the ANALYZER AND GENERATOR HARDWARE chapter. For information on how to fix the gain of the READING meter range amplifier, see the Range section at the end of this chapter.

10.3. Other Measurement Functions

The **LEVEL** line displays the data from a second voltmeter on the tunable filter module board. This second voltmeter continually monitors the analyzer signal input, prior to any LF filters, HF filters, or optional FILTERS. It always uses true rms detection. Units are selected in the field to the right of its data display. The LEVEL voltmeter lacks the full-range sensitivity of the AMPLITUDE function of the main voltmeter, but has somewhat wider bandwidth. At signal amplitudes below approximately 10 mV the LEVEL voltmeter will begin to lose high-frequency response. At amplitudes below approximately 1 mV, its resolution will become a limiting factor in accuracy, even at mid-band frequencies. Thus, noise measurements and very low level signal measurements should always be made with the AMPLITUDE function of the main (READING) voltmeter. The READING meter maintains specified accuracy at any level, but becomes limited by its noise specification at signal levels below approximately 100 microvolts (see specifications section of System One brochure). The LEVEL voltmeter flatness is typically better than the principal (READING) voltmeter for wideband true rms measurements.

The **FREQUENCY** line of the ANALYZER panel displays the frequency of the input signal. With hardware serial numbers below SYS1-20300 and in most functions with hardware above those serial numbers, the counter measures on the channel selected at the top of the ANALYZER panel. In 2-CHANNEL and CROSSTALK functions with hardware serial numbers SYS1-20300 and above, the counter measures the alternate channel.

In BANDPASS, BANDREJECT or W+F functions with hardware s/n SYS1-20300 and above, when the analyzer BP/BR frequency is swept or fixed instead of AUTO, the counter is connected to the output of the BP/BR filter. This extends the counter usable sensitivity below 250 microvolts due to 12 dB gain in the filter and permits frequency measurements of one component of a complex signal due to the filter selectivity.

The actual measurement technique is a period average measurement followed by a reciprocal calculation in the analyzer microprocessor. The number of periods averaged is automatically selected as a function of the reading rate currently in use and the signal frequency being measured. The measurement may be expressed either in absolute units (Hz and kHz) or in a number of relative units with respect to the Freq REF value entered near the bottom of the panel; see the UNITS chapter for details.

PHASE, if the PHA-LVF module is present and both channels are presented with signals above the phase measurement threshold of a few millivolts, displays the phase of the signal at the CHANNEL-B INPUT referred to the CHANNEL-A INPUT. Units are selected to the right of the measurement display.

Input-output phase measurements of a device under test may be made by selecting GEN-MONitor instead of INPUT for the analyzer channel not connected to the output of the device under test. In addition, both the A and B outputs of the generator module must be turned on. One channel of the phase meter is thus connected to the generator output (device input) and the other to the device output, providing a measurement of device input-to-output phase shift. If high-gain devices are to be meas-

ured, their required input amplitude for linear operation may be less than the approximately 2 mV sensitivity of the phase meter. In this case, the signal at the BNC connector labeled MONITOR OUTPUT (GENERATOR AUXILIARY SIGNALS) can be connected to the CHANNEL-B connector to serve as the phase reference, instead of selecting GEN-MONitor at CHANNEL-B. This MONITOR OUTPUT signal is a constant amplitude signal of approximately 1 Volt, even when the generator outputs are at very low amplitudes.

Either CHANNEL-A or CHANNEL-B may be selected as GEN-MONitor. System One software will automatically correct the phase measurements so that the GEN-MONitor channel is the reference and phase measurements are relative to it. If both channels A and B are set to GEN-MONitor, channel A will again be the reference. The panel display range can be fixed in +/-180 degree display format (deg1), -90 to +270 degree format (deg2), 0 to +360 degree format (deg3), or can be automatically selected as +/-180 degrees or 0-360 degrees, depending on the measured value (deg).

Polarity testing may be performed with System One if the BUR-GEN module is present or another asymmetrical (low duty cycle) tone burst signal is available. The signal must consist of a tone burst of approximately 30% duty cycle, with the leading edge of the burst sinewave being positive-going. All tone bursts from the BUR-GEN module are initially positive-going. Polarity mode is selectable as a unit on the PHASE line of the ANALYZER panel, shown in Figure 10-4. When **POL** is selected, the PHASE indication can be only 0 or +180. The 0 indication shows that the measured signal is positive-going; a +180 indication indicates that a polarity reversal has occurred somewhere between the generator output and the analyzer input.

Polarity testing is a requirement when testing the wiring of mixing consoles, studios, and other sophisticated multi-channel audio systems to assure that no inadvertent cable transpositions have taken place.

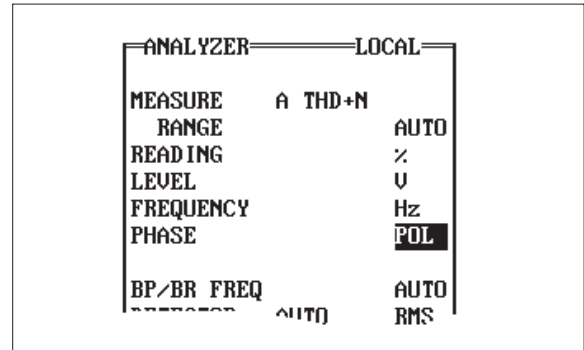

Figure 10-4 Analyzer Panel in Polarity Testing Mode

10.4. Filter Frequency Control

The BP/BR FREQ line permits control of the tuning of the bandpass/bandreject filter of the tunable filter module. Two modes are selectable—AUTO or Hz. In the AUTO mode, the filter will automatically be tuned to the generator frequency during frequency or amplitude sweeps where generator is the signal source. In sweeps with an EXTERNAL source (such as the signal from a pre-recorded test tape or disk or a distant-origination signal), AUTO mode steers the filter to the frequency being measured by the analyzer frequency counter. In panel mode with AUTO selected, the filter is also steered by the analyzer frequency data if the LEVEL voltmeter reading is above approximately 8 millivolts; below that level, the filter will be locked to the last frequency measured by the frequency counter.

When Hz is selected, the filter can be fixed-tuned to any frequency from 10 Hz to 200 kHz (+/-3%) by making a numeric entry in this field. If it is desired to transfer the present value of the FREQUENCY counter to this field, you may place the cursor on the BP/BR FREQ units (Hz) field and press <Enter>. When an ANLR BP/BR sweep is selected at SOURCE-1 or SOURCE-2, it will take control of the filter frequency during the sweep even if the ANALYZER panel selection was fixed at a specific frequency.

10.5. Detector Selection

The DETECTOR line permits selection of reading rate and of any of five detector types in the principal (analyzer) voltmeter. The actual hardware detector choices are RMS (true rms), AVG (average responding, rms calibrated), Peak (peak responding), and Q-Pk (quasi-peak response conforming with CCIR Recommendation 468-4).

The S-Pk “detector” uses the Peak detector hardware circuitry, but multiplies the measurement by 0.7071 before display. It thus displays the amplitude of a sinewave which would have the same peak amplitude as the signal being measured. It is particularly useful for expressing the output power of amplifiers with stimulus from an intermodulation distortion test signal or other non-sinusoidal signal. Using the S-Pk detector will show an amplifier’s available power at clipping to be essentially the same under sinewave or IMD waveform stimulus.

With Q-Pk, Peak, or S-Pk selections, the display automatically holds the maximum value for approximately 0.5 seconds, regardless of reading rate selection. All detectors are linear even with signal crest factors as high as 7.

The true RMS detector should be selected for accurate measurements when the signal is non-sinusoidal, such as a distortion measurement or wide-band noise measurement. If the signal is sinusoidal or sharply band-limited noise due to use of System One’s BANDPASS mode or optional bandpass filters for individual harmonic measurements, the AVG detector will exhibit faster settling, less error at low frequencies, and less noise.

10.6. Reading Rate

With the RMS detector, there is an inherent relationship between the fastest valid reading rate for full specified measurement accuracy and the lowest frequency component of the measured signal. 32 readings per second should be used only for repetitive signals faster than approximately 65 Hz. Similarly, 16 readings/sec is valid for 30 Hz and faster, 8 readings/sec for 20 Hz and faster, and 4 readings/sec

for 10 Hz and faster. These signal frequency limitations pertain not only to a single sine wave, but to the difference between the two most closely spaced components of a complex signal. For example, when measuring THD+N at 35 Hz in an amplifier with significant 60 Hz hum from the power mains, a 10 Hz beat product can exist between the power mains hum at 60 Hz and the second harmonic at 70 Hz. Properly measuring the amplitude of the signal, including this 10 Hz beat, would require use of the 4 readings/sec detector selection.

The field between the DETECTOR label and the detector type selection controls the update rate of the four measurements (READING, LEVEL, FREQUENCY, and PHASE). The five selections are AUTO, 4/sec, 8/sec, 16/sec, and 32/sec. If any of the four fixed selections are chosen, the update rate will be fixed at the selected rate during all modes of operation. If AUTO is selected, a software algorithm takes control of the reading rate. This algorithm selects 4/sec in panel mode and chooses appropriate selections under other conditions depending upon the display mode, signal waveform being generated, SOURCE-1 and SOURCE-2 selection, analysis function, and generator or bandpass filter frequency. See the “Auto and Fixed Sampling Rates” section of the SWEEP (F9) DEFINITIONS PANEL chapter for full information on these selections. Detector time constants are also switched along with the reading rate. The AUTO algorithm also causes the 22 Hz high-pass filter to be selected whenever the source frequency is above 60 Hz in a sweep.

Reading rates faster than the recommendations above may be used with some loss of accuracy, which may be an acceptable tradeoff in specific applications. Rates slower than the AUTO selections are required in some applications, such as when using the LEVEL meter at very low amplitudes. AUTO mode is generally recommended except for special cases. During swept frequency measurements with external sources, a faster reading rate may normally be selected consistent with the lowest frequency signal expected at which accuracy is to be maintained. Faster rates may be desirable for good information feedback during equipment adjustments using bargraph display mode.

10.7. Bandwidth Control

Both low and high frequency band limits of the principal (READING) voltmeter are controlled from the BANDWIDTH line. The low frequency band limit is controlled from the field immediately after the BANDWIDTH label. With no filter selected, the lower 3 dB limit is <10 Hz (typically approximately 4 Hz in amplitude modes and 6 Hz in THD+N or BAND-REJECT modes). Three-pole high-pass filters at 22 Hz, 100 Hz, and 400 Hz are selectable.

The right-hand field on the BANDWIDTH line similarly controls the upper band limit. With no filters, the bandwidth is in excess of 500 kHz. Three-pole low-pass filters at 80 kHz or 30 kHz may be selected. The 22 kHz low-pass filter selection is made up of three poles at 22 kHz, cascaded with the three-pole 30 kHz filter. The resulting six-pole response above 30 kHz produces somewhat greater attenuation of signals such as the 44.1 kHz or 48 kHz sampling frequency in digital systems.

In intermodulation distortion modes and wow and flutter modes, the bandwidth line becomes an indicator of detection bandwidth used in the selected mode.

10.8. Optional Filters

Optional FILTER capability on analyzers below s/n SYS1-20300 consists of four sockets on the analyzer module circuit board. Units with serial SYS1-20300 and above add a fifth socket plus front-panel BNC connectors for externally-connected filters. Optional filters made by Audio Precision may be plugged into the sockets. A blank circuit board is also offered for the sockets to allow user design and fabrication of custom filter designs. The ANALYZER panel shows the choices of OFF, #1, #2, #3, #4, #5 (s/n SYS1-20300 and higher only), EXTERNAL (s/n SYS1-20300 and higher only), CCIR, CCIR-2K, and "A"WTG whether or not filters are actually installed. Selecting an unoccupied socket will result in erroneous readings.

If a CCIR weighting filter is used, it must be installed in socket #1, nearest the rear panel of System One. If an A weighting filter is used it should be installed in the #2 socket, second from the rear. When any filter (A-weighting or otherwise) is installed in the #2 socket, it can be selected either with the #2 or the "A"WTG selection on the panel with identical results.

If a filter is plugged into socket #1, however, the results will be different depending on whether it is selected on the panel as #1, CCIR, or CCIR-2K. The #1 panel selection chooses the #1 socket with unity gain, as is appropriate for all available filters except the CCIR weighting filter. The CCIR selection also selects the #1 socket, but with a software-controlled gain factor of 12.22 dB (4:1 attenuation). This value is required in conjunction with the actual electrical gain through the CCIR filter to produce unity gain at 1 kHz as specified in CCIR recommendation 468-4 and earlier. Selecting CCIR-2K again selects the #1 socket, but with a software-controlled gain factor of 5.92 dB. This value produces the unity gain point at 2 kHz, as specified by Dolby™ for the CCIR-ARM noise measurement method (in conjunction with the AVG detector).

Other available filters include C-message and CCITT weighting filters, the receiver bandpass filter (200 Hz to 15 kHz bandpass plus 19 kHz notch), and a precision 20 kHz band limiting filter with sharp rolloff.

The FBP-*nnn* family of bandpass filters are intended for individual harmonic distortion measurements, especially with tape recorders. For example, assume that a 1 kHz fundamental tone is recorded on tape and that 2 and 3 kHz filters (FBP-2000 and FBP-3000) are plugged into sockets #3 and #4. Selecting THD+N mode with no optional filters selected will produce a READING of total harmonic distortion plus noise. Further selecting socket #3 (2 kHz bandpass) would produce a reading which is purely second harmonic. Selecting the #4 socket (3 kHz bandpass) would provide a third harmonic reading.

10.9. Input Configuration

The next two pairs of lines on the ANALYZER panel are input configuration controls for the channel A and channel B input circuitry. Selections are independent for the two channels. The INPUT vs GEN-MONitor (vs AUXILIARY, on units s/n SYS1-20300 and above) selection chooses either the panel connectors (INPUT) or an internal cable to the corresponding generator output connector (GEN-MONitor) to allow monitoring of the generator terminal voltage. An auxiliary input connector is added on units of serial number SYS1-20300 and above and may be selected as an A channel input in addition to the INPUT and GEN-MONitor choices.

The TERMination line permits selection of a 150 Ohm or 600 Ohm input termination or the 100 kilohm high impedance bridging input for the INPUT connector. A 300 Ohm selection replaces the 150 Ohm selection when the EURZ option is installed and the software properly invoked at start-up. Since excessive power dissipation is a potential problem with the low impedance terminations, they will be automatically disconnected if the input signal level exceeds approximately +32 dBu (30 Volts). The GEN-MONitor connection does not load the generator, even if a termination has been selected for the INPUT connector.

In all cases except the AUXILIARY input of units above serial SYS1-20300, the input is fully balanced (differential). The AUXILIARY input is unbalanced due to use of a grounded-type (BNC) connector.

Input RANGE will nearly always be left in the AUTO mode, though a manual range may be selected for certain specialized applications. The autoranging control circuitry responds to the peak value of the input signal, rather than the rms or average value as in other audio test equipment, preventing overload and non-linearity on signals with high crest factors. Note that the input manual range selection (under CHANNEL-A and CHANNEL-B) fixes only the input auto-ranging circuitry. The range amplifier circuitry located later in the READING meter circuitry can be fixed in the RANGE field near the top of the ANALYZER panel.

The balanced inputs to the analyzer appear at pins 2 and 3 of the XLR connectors. When making adapter cables from the XLR connectors to unbalanced connectors such as RCA phono or standard or miniature phone plugs and jacks, pin 2 of the XLR must be wired to the center conductor of the unbalanced cable. Pin 3 of the XLR must be wired to the shell of the RCA phono or sleeve connection of the phone plug or jack. ***When stereo devices (balanced or unbalanced) are being tested, take care that the left and right channel cables between System One and the device are tightly dressed together or even twisted to reduce the loop area into which hum can be magnetically coupled.***

A separate ground connection may be made from the chassis of the device under test to the GROUND connector on the analyzer input connector panel. If stimulus is also provided from System One, only one ground connection should be made between the device under test and System One. Experimentation may be required to see whether lower noise results with that connection made to the generator panel or the analyzer panel.

10.10. Reference Values

dBr REF is the zero dB reference for the dBr units of both the principal analyzer voltmeter and the LEVEL voltmeter. The default value at power-up is 387.3 millivolts, the voltage across a 150 Ohm resistor when one milliwatt is being dissipated in the resistor. A new dBr value may be entered into the numeric entry field, or the present value of a measured parameter may be transferred to this field by pressing either the <F4> function key, or by pressing the <+> or key while the cursor is on the dBr numeric entry field. This capability is extremely convenient in setting the reference level for frequency response sweeps, gain and loss measurements, signal-to-noise ratio measurements, common mode rejection ratio measurements, separation and crosstalk measurements, or other relative audio measurements.

When the <F4> key is pressed to set the dBr REF value, System One goes through the following priorities to determine which measurement will be entered into the dBr REF field:

1. If the principal voltmeter (READING) has dBr units selected on the ANALYZER panel, use the principal voltmeter reading
2. If the LEVEL voltmeter has dBr units selected on the ANALYZER panel, use the LEVEL voltmeter reading
3. If the READING voltmeter is in AMPLitude function or BANDPASS function or BANDREJECT function, use the principal voltmeter reading
4. If the READING voltmeter is in THD+N function with Volts or dBm or dBu or dBV or dBr, use the principal voltmeter reading
5. If both READING and LEVEL voltmeters are set to OFF on the ANALYZER panel, use the principal voltmeter reading
6. Otherwise, use the LEVEL voltmeter reading.

Note that the dBr REF value is not instantly changed when the <F4> key is pressed. This is due to a 200 millisecond delay, plus the SETTling panel criteria (see SWEEP (F9) DEFINITIONS chapter) being applied to the readings from the hardware, just as they are during graphic sweeps. This delay helps assure that stabilization is achieved after a test is loaded during a procedure, immediately before the dBr REFERENCE is set.

The dBr unit may be used in THD+N modes for applications such as expressing quantization distortion in digital systems in dB above the theoretical floor for the number of bits in the digital word. Assuming that the full-scale output voltage of the digital device is known, the theoretical floor can be computed in the units desired and entered into the dBr REF field. Selecting dBr as the THD+N units will then provide a reading of "excess distortion" above the ideal value. If an actual THD+N reading is to be entered into the dBr REF field by pressing the <F4> key (case 4 in the priority list above), care must be taken that none of the higher priorities will

override. Specifically, this means that dBr *must not* be selected as the LEVEL voltmeter unit, or case 2 would be in effect.

Units for the dBr REF value may be selected in the usual fashion by the field following the numeric field.

The dBm/W REF field is used to enter the value of circuit impedance across which the analyzer input is connected so that power measurements (dBm or Watts) can be correctly computed. Any numeric value may be entered into this field. This entry is not automatically made or changed when selecting analyzer input termination values, since the analyzer has no way of knowing what external impedances may be in parallel with its input. If the selected input impedance of System One cannot be neglected in comparison to external terminations, the parallel combination of the two must be computed and entered by the operator into the dBm/W REF field.

The Freq REF field is used to enter a reference frequency which will be used in all relative frequency units. Typical applications include tape and disk player speed (drift) measurements, measurements of the frequency drift of an oscillator, measurements of the frequency error through frequency-division-multiplex equipment, measurement of the slope (in dB per octave or dB per decade) of a filter, and measurement of musical notes in the terminology used by instrument tuners. The Freq REF value may be entered into this field from the keyboard, or the presently-measured frequency from the analyzer frequency counter may be automatically entered by pressing <Alt><F4>. See the UNITS chapter for a discussion of the units.

10.11. Range

The System One analyzer has gain range switching circuitry in three places. Each input channel, A and B, has switchable attenuators and gain stages immediately following the input connectors. The READING meter also has switchable gain stages prior to the low-pass, high-pass, and optional filters (see Figure 32-1 on page 32-2 of the Analyzer and

Generator Hardware Chapter). For the majority of System One operation, these three gain-control blocks should be left under AUTO control.

There are two reasons why selecting a fixed gain range may be desirable; speed, and transient-free MONITOR OUTPUT signals. During AUTO range operation, significant time is required for the autorange circuitry to detect that the signal is outside the optimum range for the present settings and to change the range. Changing is then normally accomplished one step at a time. The time required depends upon the reading rate, which in turn normally depends upon signal frequency and thus becomes longest with low frequency signals. A common case is when signal is removed and restored, either because the generator output is turned off and on or when one device is disconnected and another connected. When signal is removed in AUTO range mode, the instrument sensitivity is automatically increased one step at a time until the most sensitive range is reached. When signal is restored, the sensitivity is decreased one step at a time until the optimum range is found for the signal. The period of time required may be many hundreds of milliseconds or even more than one second.

With fixed ranges, this autoranging time is eliminated. The risk of a fixed range is that the signal may move outside that range. If the signal amplitude increases above the range maximum, clipping can occur in the analyzer amplifiers with severe amplitude errors, increased distortion, and apparent frequency multiplication resulting. If the signal amplitude decreases below the range minimum, the effects are less catastrophic but distortion and noise measurement performance will be limited and below instrument specifications as the signal approaches the instrument internal noise levels.

Note in Figure 32-1 on page 32-2 that the CHANNEL A and CHANNEL B MONITOR OUTPUT BNC connectors follow the input ranging circuits and the READING MONITOR OUTPUT BNC connector follows the READING meter selectable gain stage. As the signal amplitude rises or falls, the signal present at these BNC connectors tends to remain at a relatively constant amplitude but with sudden transient changes each time a range is switched. If

these transients are undesirable for a particular monitoring purpose, or if it is desired that the signal at these connectors linearly follows the input signal up and down, the ranges can be fixed. It is not necessary to fix the range of the READING meter gain amplifier in order to eliminate transients from the CHANNEL A and B MONITOR OUTPUTS, but both the INPUT RANGE for the channel in use and the READING RANGE must be fixed to eliminate transients at the READING MONITOR OUTPUT.

For improved speed or to eliminate MONITOR OUTPUT transients, it may be preferable to lock any or all of these circuit blocks into fixed gain ranges. Each input channel range block is controlled by the right-hand field following the RANGE label, on the line below the CHANNEL-A and CHANNEL-B labels. The READING meter channel gain amplifier may be fixed (in most functions and modes) by the right-hand field on the RANGE line immediately below the MEASURE label near the top of the analyzer panel.

If any of these fields is changed from the normal AUTO selection, the gain of the circuit block controlled will be fixed at the present value (which had been automatically selected depending upon the signal or noise amplitude present at the time). Thus, the easiest way to specify a fixed range is to apply a signal to the analyzer inputs at the absolute maximum level which can occur for the particular test to be made. Then, change the field(s) from AUTO and save the test with the resulting value stored. To select other fixed-range values, the cursor can be placed in the field to the immediate left. In the

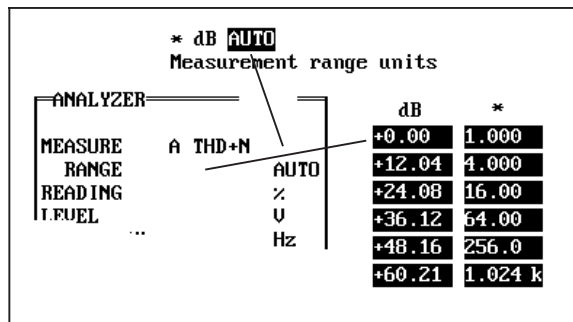

Figure 10-5 READING Meter Gain Amplifier Gain Fixing Fields and Selections

cases of the two INPUT channels, a variety of amplitude units is selectable and any desired signal amplitude may be typed into the field, followed by <Enter>. The software will then select and display the most sensitive range which will not be overloaded by a signal of that amplitude.

For the READING channel, only a small number of gain ranges are selectable (see Figure 10-5). This gain value may be displayed either in dB or as a gain ratio with the "*" unit. The <+> and keys may be used to scan up or down through the available gain ranges. In AMPLITUDE and 2-CHAN functions, the available gain ratios are 1, 4, 16, 64, and 256 (gains of 0.00, +12.04, +24.08, +36.12, and +48.16 dB). In all remaining READING meter functions except W&F, an additional 1024 gain value (+60.21 dB) is available. In the W&F function only AUTO is permitted because the analyzer operates in a single range.



11. SWEEP (F9) DEFINITIONS PANEL

Much of the power of System One comes from its easy setup and use of sweeps of frequency or amplitude, or measurements versus time. The parameters for these tests are controlled from the SWEEP (F9) DEFINITIONS panel section.

11.1. Stimulus and Horizontal Axis Control

Near the bottom of the SWEEP (F9) DEFINITIONS panel, on the SOURCE-1 line, you can select GEN, ANLR, SWI, DCX, DSP, or EXTERN as the stimulus source for a sweep test. GEN and ANLR are the System One generator and analyzer, respectively. SWI refers to the SWR-122 family of

System One switching modules. DCX refers to the DCX-127 module. DSP is the Digital Signal Processing Module. EXTERN is for use with external sources such as pre-recorded test tones from a compact disc or test tape, or a test signal originating at a distant location. EXTERN mode is also used for TIME (chart recorder) measurements.

11.1.1. Source-1 Generator

When GEN is selected, subsidiary choices in the field to the right may be made from FREQUENCY sweeps, AMPLitude sweeps, or NONE (a single point measurement with tabular display). If the BUR-GEN option is installed, the three further

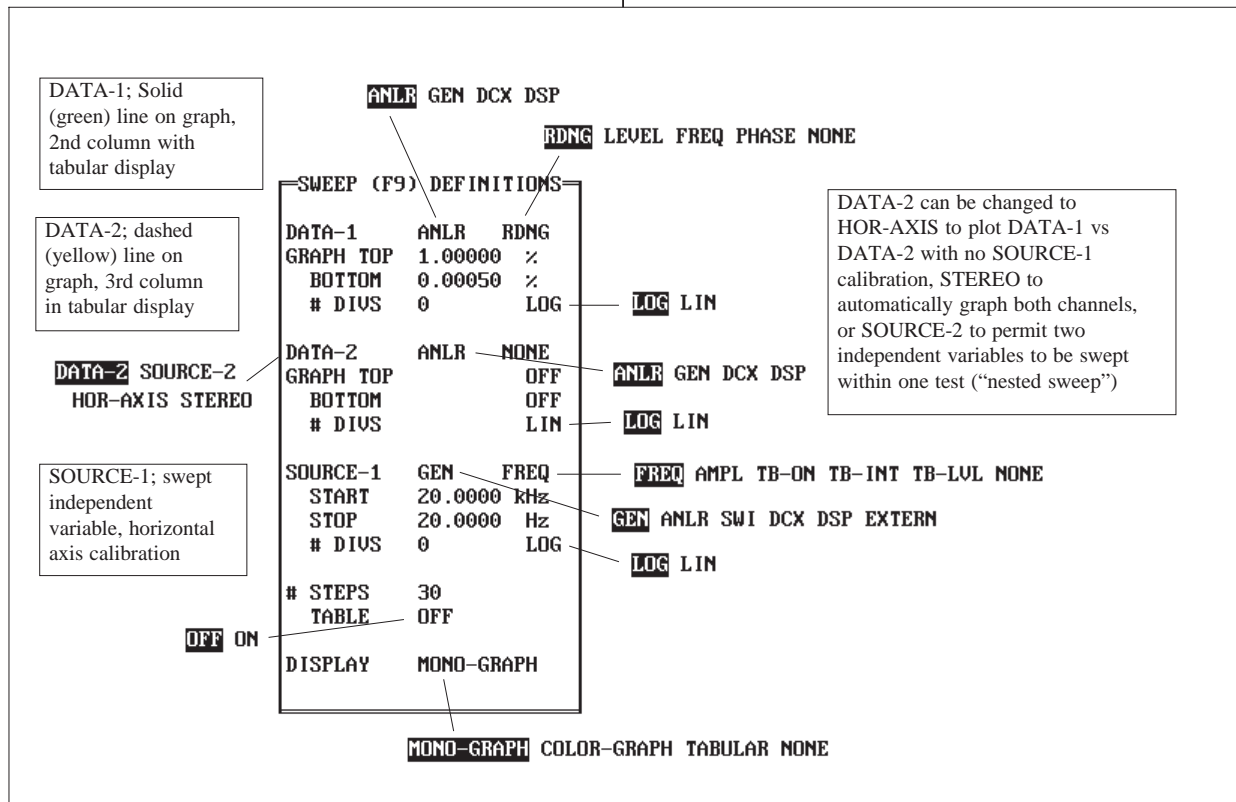

Figure 11-1 Sweep (F9) Definitions Panel

choices of TB-ON, TB-INT, and TB-LVL will be effective. TB-ON sweeps the tone burst on time, TB-INT sweeps the tone burst interval, and TB-LVL sweeps the amplitude of the lower level of the burst signal. See the BURST-SQUAREWAVE-NOISE GENERATOR chapter for more details.

Frequency sweeps using the generator as the source are made by selecting GEN FREQ as SOURCE-1. The software will vary the frequency according to the SWEEP (F9) DEFINITIONS panel. The amplitude setting and all other conditions set up on the generator panel will be maintained, unless EQSINE mode is selected on the GENERATOR panel or GEN AMPL is selected at SOURCE-2 (see nested sweeps, below). If the EQSINE mode is selected or a nested sweep is being run, the generator amplitude will also be controlled. Similarly, amplitude sweeps with the generator use the SWEEP (F9) DEFINITIONS panel for amplitude control but maintain frequency and all other conditions as set on the generator panel, unless GEN FREQ is selected at SOURCE-2. A test made with the NONE selection will take a single point measurement at the amplitude and frequency conditions set on the GENERATOR panel. The NONE selection automatically produces tabular output if either MONO-GRAPH or COLOR-GRAPH is selected for DISPLAY.

11.1.2. Source-1 Analyzer

With the ANLR choice, the sweepable parameter is the frequency of the DIS-1 bandpass/bandreject filter (BPBR) in BANDPASS or BANDREJECT modes. NONE can also be selected with ANLR for a single-point measurement.

11.1.3. Source-1 Switcher

A number of modes are available for switcher control when SWI is selected; see the SWITCHER chapter for more information.

11.1.4. Source-1 DCX

The DCX selection can produce sweeps of either variable DC output of the DCX-127 or of the parallel digital output word of the DCX-127. See the DCX-127 chapter for more details.

11.1.5. Source-1 DSP

The DSP selection choices depend upon the particular Digital Signal Processing program downloaded to the DSP module. See the Digital Signal Processor chapter and the documentation with each individual DSP program for more details.

11.1.6. Source-1 External

Under the EXTERNAL source selection, FREQUENCY sweeps, LEVEL sweeps, or TIME (“chart recorder” mode) may be selected. The units available on the START and STOP lines are those appropriate to the independent variable (FREQ, LEVEL, TIME, switcher channel, etc.) and choices are made from among them just as on the GENERATOR or ANALYZER panels.

11.1.7. Other Source-1 Parameters

The # STEPS parameter allows control over the resolution of the stimulus in the test. # DIVS gives control over the number of division lines (tic marks) in LINear modes; in LOG modes, a standard logarithmic set of division lines will always be used. In linear sweep modes with MONO-GRAPH display, the maximum number of horizontal divisions selectable is 13 except during SWItcher scans, when up to 25 divisions may be selected (plus the single case of 30 divisions). Entering 0 for the # DIVS will cause the software to make an automatic selection. In COLOR-GRAPH display with the low resolution CGA displays and linear sweep, the automatic selection mode is always used except for SWItcher scans, when up to 25 divisions may be selected.

Frequency and amplitude sweeps may be made from high to low or low to high, and the switchers may be scanned in either direction. Measurements versus TIME (chart recorder mode) must be in the direction of increasing time. Direction is controlled by selecting the end points appropriately on the START and STOP lines. For most applications, frequency sweeps from high to low are preferred since most real world devices and System One settle faster at high frequencies. Though sweeping from high to low does not always reduce the total sweep time, it provides more data on the screen quickly to begin interpretation of while the low frequency portion of the sweep is being completed.

Low to high frequency sweeps may be preferred when phase is being graphed with the deg (degrees) or rad (radians) units selected on the SWEEP (F9) DEFINITIONS panel. When plotting with either of these units, System One software automatically adds multiples of 360 degrees to phase measurements as required to obtain a continuous graph even through many complete phase rotations. Starting at low frequency may be advantageous since phase delay through a system may be less at low than at high frequencies (unless the system includes high-pass filtering). If this automatic plotting of phase as a continuous function is not desired, the units on the SWEEP (F9) DEFINITIONS panel may be selected as deg1 (fixed 180 degree range), deg2 (fixed -90 to +270 degree range), or deg3 (fixed 0 to 360 degree range). Fixing the phase range as deg1 may be particularly valuable when using Bargraph mode to display phase error while adjusting tape head azimuth on tape recorders.

START and STOP values in EXTERNAL sweep mode (see below) must be selected to correspond with the direction of sweep of the external source, since System One avoids retrace effects by not plotting the line between data points when transitions occur in the direction opposite to that implied by the START and STOP values; see the External Sweep section below for more details.

11.2. Generator Sweeps and Analyzer Filter Sweeps

Generator frequency or amplitude sweeps and analyzer bandpass/bandreject filter frequency sweeps are not truly continuously-varying analog sweeps, but a series of fixed points.

11.2.1. System-Computed Sweeps

If the SWEEP TABLE feature is OFF, or if no test file has been named as the SWEEP SOURCE, the system will compute all intermediate values for sweeps. (See the Table-Based Sweeps section below for an alternative method.)

The STEP TYPE may be selected from LOG or LIN. With LOG selected, the span between the START and STOP points will be divided into the number of logarithmically equal (constant multiplier) steps specified by the # STEPS value. If LOG is selected but zero or a negative number entered for either the START or STOP value, the system will default to LIN since the logarithm of zero and negative numbers is not defined. The sweeping device (generator or analyzer filter) will then proceed through them. LIN operation is similar except that the span between START and STOP is divided into arithmetically equal steps. In LIN operation, the START and STOP values will exactly determine the limits of the graph. In LOG mode, the graph limits will always be set to significant figures of 1, 2, 3, 5, or 8.

The number of steps desired can be entered on the # STEPS line. Note that the number of stimulus and measurement *points* will be one greater than the number of *steps*. For example, if you select # STEPS as 1, two points will be generated (START value and STOP value). Zero steps can be specified to produce a single measurement point at the START value of the "sweep", though selecting NONE as the sweep parameter is generally the preferable way of obtaining single point measurements.

Generator frequency and analyzer BP/BR filter frequency sweeps can also be made in relative frequency units rather than absolute Hz and kHz. Gen-

erator relative frequency sweeps are with respect to the number in the REFS Freq field of the GENERATOR panel. Analyzer relative frequency sweeps are with respect to the number in the REFS Freq field of the ANALYZER panel. Acoustical analysis work can be simplified, for example, by sweeping the analyzer 1/3 octave filter in 1/3 octave steps by selecting OCTS instead of Hz/kHz as SOURCE-1 units and choosing the START, STOP, and # STEPS values properly. For example, with START at +2 OCTS and STOP at -2 OCTS, 12 STEPS will produce 1/3 octave steps across that 4-octave span. The BPASS noise mode or sine wave of the generator can be similarly stepped in fractional octave or fractional decade steps of any desired size.

With the standard memory space allocation procedure and a computer with sufficiently large memory, the upper limit on the # STEPS which can be saved or re-plotted is 1089. For any specific computer size and memory space allocation, press <Esc> <H> to display the HELP panel, which will show the maximum number of steps available. Sweeps may be run on-screen (and printed to paper) with a larger number of steps than the maximum shown, but saving the test or re-plotting via the <F7> key will only save or re-plot the initial portion of the sweep up to the maximum limit. Larger numbers of steps, up to 16,000 maximum, can be accommodated by reducing the size of memory allocations for other buffers. See the Controlling Memory Usage section of the CREATING YOUR CUSTOM SOFTWARE START-UP PROCESS chapter for more details.

The optimum number of steps to select is a trade-off between time and data detail. A larger number of steps will take more test time and produce more detailed data. For distortion versus frequency sweeps of typical devices from 20 Hz to 20 kHz, 10 to 30 steps is usually adequate. Frequency response measurements of relatively flat devices such as most power amplifiers can also be shown adequately with 30 steps or less, while frequency response measurements of equalizers, loudspeakers, and similar devices with rapidly-changing response may profit by 75 to 100 steps or even more.

A practical upper limit on the number of steps for graphic display is set by the graph size and the graphic resolution of the computer display system; in CGA color displays, about 255 points (200 if two parameters are being graphed) is the horizontal graphic resolution limit; in EGA and VGA color graphics, monochrome graphics with a CGA system, or the Toshiba 3100 orange monochrome display, about 575 points (520 with two parameters graphed) is the horizontal graphic limit; and with the Hercules high-resolution monochrome graphics, about 615 points (560 with two parameters) is the horizontal graphic resolution limit. (The principal advantage of the Hercules card is 348 point vertical resolution compared to 200 vertical points with the CGA card.)

11.2.2. Table-Based Sweeps

System One also supports table-based sweeps. This feature may most commonly be used in production test applications, when it is desired to test at certain exact points across the frequency or amplitude range being tested. This may be desirable as a time saving technique if, for example, high detail of frequency response is critical at certain portions of the spectrum (such as at band edges) but response is non-critical or simply unlikely to vary across other areas, such as mid-band. Another application of table-based sweeps is in testing graphic equalizers, real time analyzers, or other filter-bank devices; the table can consist of the specified center frequencies for each filter in the bank.

Table-based sweeps make use of the STEP TABLE ON/OFF line and the Names Sweep menu command. The Edit Data and Save Sweep capabilities are normally used to create a sweep (.SWP) file to be used as the sweep source table.

The simplest method of creating a sweep source table is to set up the SWEEP (F9) DEFINITIONS panel for the type sweep (FREQUENCY or AMPLITUDE) desired, specifying the units you wish to use in the table, and with a # STEPS value equal to one less than the number of values you plan to have in the table. It is also convenient, though not critical, to select as the START and STOP values those numbers which you plan to have as the end values in the

table. Press <F9> to run a test in this condition, then press <Esc> EDIT DATA to bring the tabular listing of that sweep into the edit buffer.

You may now replace the computer-generated intermediate values with the specific values you wish to have in your table; if you specified the START and STOP points correctly on the SWEEP (F9) DEFINITIONS panel, you will not need to change them. The values should be monotonic (proceeding continuously from high to low or low to high, with no reversals) if the test which will use the table will be graphed or will have comparison limits attached. Data entries in the second and third columns are irrelevant; they will not be used when this xx.SWP file is being used as a sweep source table. It is necessary, however, for the second and third columns to have either units or OFF listed as column heads. It is also necessary for each value in a column (other than the last column) to be followed with a comma to delimit it from the following value on the same row. SAVE the SWEEP, specifying a file name which will remind you of its intended use; the xx.SWP extension will be added automatically.

Now, go to panel mode and create the test which will use this table. If the test is a generator-based sweep, set up the GENERATOR panel for the other major generator parameter (AMPLITUDE if your table controls frequency, FREQUENCY if your table controls amplitude). Select the generator output configuration plus all analyzer conditions, and the remainder of the sweep definitions panel. Set STEP

sec	V
0.003861944,	10.030220990,
0.114436939,	10.030220990,
0.212567880,	10.030220990,
0.311074286,	10.033402440,
0.409339338,	10.030220990,
0.507604360,	10.033402440,
0.605869412,	10.033402440,
0.704241752,	10.033402440,
0.802506804,	10.030220990,
0.900771856,	10.033402440,
1.031863451,	10.033402440,

Figure 11-2 Time Measurement Example

TABLE to ON. Note that while the STEP TYPE LOG/LIN line will not control the relationship between actual swept values when a table is in use, it will determine whether the horizontal axis of the graph (if graphic display is selected) will be logarithmic or linear. Similarly, the START and STOP values will control the calibration of the horizontal graph axis, even though the actual points at which testing is done are controlled by the table and may be within or outside the span covered by START and STOP. If DISPLAY TABULAR will be selected, START and STOP are irrelevant as long as they are not equal.

When the panel is set up for the test, use <Esc> and the Names Sweep menu command to specify as the sweep source table the xx.SWP file you created for the table. You may now Save Test under an appropriate name. Whenever this test is loaded and run, it will use the values from the sweep source xx.SWP file specified instead of the START and STOP values and computed intermediate sweep points. If you copy tests to other disks or sub-directories on a hard disk, remember to keep the sweep source table on the same disk or directory as the xx.TST file which calls it, or specify the full path with the name. Otherwise, an error message will result and the test will not run.

11.2.3. Measurements Versus Time

Measurements versus TIME do not override any settings of the generator or analyzer panels. They simply cause a sampling of the DATA-1 and DATA-2 parameters (see below) across the total time interval specified by START and STOP. The exact times at which measurements will be made depends on the choices of # STEPS and START and STOP

sec	V
0.026309493,	10.029823300,
0.288385361,	10.031414030,
0.550702631,	10.031811710,
0.812644362,	10.031414030,
1.074961662,	10.031811710,

Figure 11-3 Time Example, Low Reading Rate

times on the SWEEP (F9) DEFINITIONS panel, the reading rate selected on the ANALYZER panel, and the number of data samples and the settling tolerances and resolutions selected on the SWEEP SETTLING panel. An example may be the best way to explain these relationships. If a START time of 0 and STOP time of 1 second are selected and 10 is entered as # STEPS, the system will attempt to take eleven measurements with the first near zero time, the second at one hundred milliseconds, etc. If a reading rate of 32/sec is selected on the ANALYZER panel and if SETTling is turned OFF on the SWEEP SETTLING panel, the actual sample times will vary between the exact specified instants and approximately 1/32 second later. Figure 11-2 shows the EDIT DATA results of such an EXTERN TIME measurement, with the actual times lagging the specified by amounts ranging from as little as 0.77 milliseconds to as much as 31.8 milliseconds. Note that the displayed resolution does not indicate an equivalent absolute accuracy.

If a slower reading rate, such as 4/sec, were selected, the actual samples could lag the ideal times by as much as 1/4 second. In this case, eleven samples would not be taken. The system will take the first available sample after time zero, but each sample at the 4/sec rate will inhibit the taking of some of the succeeding samples. In the 4 readings/sec example of Figure 11-3, the nominal 0.1 second sample did not occur until 0.288 seconds due to the approximate 1/4 second (actually 262 milliseconds in this case) interval between samples. This eliminated the nominal 0.2 second sample; the nominal 0.3 second sample was taken at 0.55 seconds, eliminating any possibility of the 0.4 and 0.5 second samples; the nominal 0.6 second sample occurred at 0.812 seconds, and the nominal 1.00 second sample occurred at 1.07 seconds.

If settling is not turned OFF on the SWEEP SETTLING PANEL, an additional time element will be introduced as the system compares consecutive data points with one another and with the specified TOLERANCE and RESOLUTION values to assure that data is settled before retaining a sample; see the SWEEP SETTLING section later in this chapter for

a fuller description of this feature. It is likely that in many TIME measurements, settling will be turned OFF.

The <F10> (pause) key, during TIME measurements, only inhibits the taking of measurements; it does not delay the generation of triggers to the elapsed time clock. When <F10> is operated again to permit graphing, the computer will begin measuring and graphing at a point determined by the time between operations of <F10>, not at the time-zero point on the graph.

11.3. Measurement Parameters and Vertical Axis Control

The DATA-1 and DATA-2 lines at the upper and central portions of the SWEEP (F9) DEFINITIONS panel permit selection of analyzer (ANLR), generator (GEN), DCX-127 (DCX), or digital signal processor (DSP) parameters to be plotted. If ANLR is chosen, any of the four measured parameters at the top of the ANALYZER panel may be plotted, and the graphic coordinates may be selected for display of those measurements. The measurement parameter selected at DATA-1 (at the top of the SWEEP panel) will be graphed by a solid line (green on a color display) and calibrated at the left side of the graph, with the grid drawn across the entire graph. The parameter selected at DATA-2 (at the center of the SWEEP panel) will be drawn with a dashed line (monochrome) or yellow line (color), and calibrated with a narrow column of tic marks at the right edge of the graph. It is also possible to plot two measured parameters versus one another as an x-y plot; see the section "Plotting Versus Measured Parameters" below for details.

The choices of analyzer (ANLR) parameter to be plotted as DATA-1 or DATA-2 are RDNG, LEVEL, FREQ, PHASE, and NONE. RDNG refers to the main analyzer measurement voltmeter whose measurements are displayed on the READING line on the ANALYZER panel. The function of this meter may be set to AMPLITUDE, BANDPASS, BANDREJECT, THD+N, SMPTE, CCIF, DIM, W&F, CROSSTALK, or 2-CHANNEL (if the appropriate hardware options and versions are installed).

LEVEL refers to the LEVEL voltmeter on the DIS-1 module, which continuously monitors the input signal prior to any filtering. FREQ and PHASE are the analyzer frequency counter and phase meter, respectively. Polarity test display is via the PHASE selection. When POL is selected as the phase “unit” on the ANALYZER panel, only POL units are available at DATA-1 or DATA-2.

Generator amplitude may also be plotted as DATA-1 or DATA-2 by selecting GEN instead of ANLR in the field following DATA-n, then selecting AMPL or INVAMP as the generator parameter to be plotted, with appropriate units. It is useful to plot generator amplitude if it is not held constant during sweep tests, such as in the REGULATION mode (see the REGULATION chapter) or in the equalized sweep mode (see the EQUALIZATION chapter). Selection of INVAMP causes dBr to be plotted. This is useful in REGULATION mode when measuring frequency response of a system at constant output by varying the generator amplitude. To produce a conventional frequency response graph, the inverse of generator amplitude must be plotted since a gain fall-off of the device under test will require more generator amplitude in order to hold output constant.

When DCX is selected at DATA-1 or DATA-2 (or HOR-AXIS or STEREO instead of DATA-2), further selection may then be made of the DCX-127 digital voltmeter (DMM) or digital input (DIGIN). The voltmeter selection will graph voltage or resistance, depending on which function is selected on the DCX-127 panel. See the DCX-127 chapter for more details.

When DSP is selected at DATA-1 or DATA-2, the further selections for parameter to be plotted are totally dependent upon the particular DSP program which has been downloaded to the DSP module. See the documentation for each DSP program for details.

The fields to the right of GRAPH TOP and BOTTOM permit setting the graph’s upper and lower boundaries. Units of display for each parameter may be selected from those appropriate for the parameter being measured. The units selected on the

sweep panel for display on the graph are independent of the units selected for numeric display of the same parameter on the ANALYZER panel, with the exception of absolute versus relative units in distortion modes, CROSSTALK mode, and 2-CHANNEL mode. For graphic display in one of the relative units (% , dB, PPM, or X/Y), a relative unit must be selected on the ANALYZER panel. For graphic display of absolute units, (Volts, dBm, dBu, dBV, dBr, W) an absolute unit must be selected on the ANALYZER panel.

LOG or LIN vertical display may be selected; **LIN is automatically chosen if the GRAPH TOP or BOTTOM value is zero or negative.** The # DIVS (which functions only with LIN vertical displays) controls the number of divisions into which the graph will be divided. A 0 entry causes an auto-division-mark selection. The maximum number of divisions is 20. With LIN selected, the graph top and bottom lines will be exactly the values specified in GRAPH TOP and BOTTOM. **In LOG mode, the graph top and bottom will always be lines with significant figures of 1, 2, 3, 5, or 8.**

11.4. Graphic and Tabular Display

At the very bottom of the screen, select DISPLAY MONO-GRAPH, COLOR-GRAPH, TABULAR, or NONE.

In COLOR-GRAPH mode with a CGA display system, because of the lower resolution of the color graphics card in the computer, larger alphanumeric characters are required for legibility. The size of these characters forces the omission from color graphs of several pieces of information displayed on monochrome graphs. These include the title (AUDIO PRECISION unless changed via the Names Title function), the test name, and the date and time. The actual graph area of CGA color graphs is also smaller than monochrome and the graphic resolution is poorer. EGA and VGA COLOR-GRAPH displays do not sacrifice detail for character size for color due to their higher resolution capability. Color graphs are attractive and are sim-

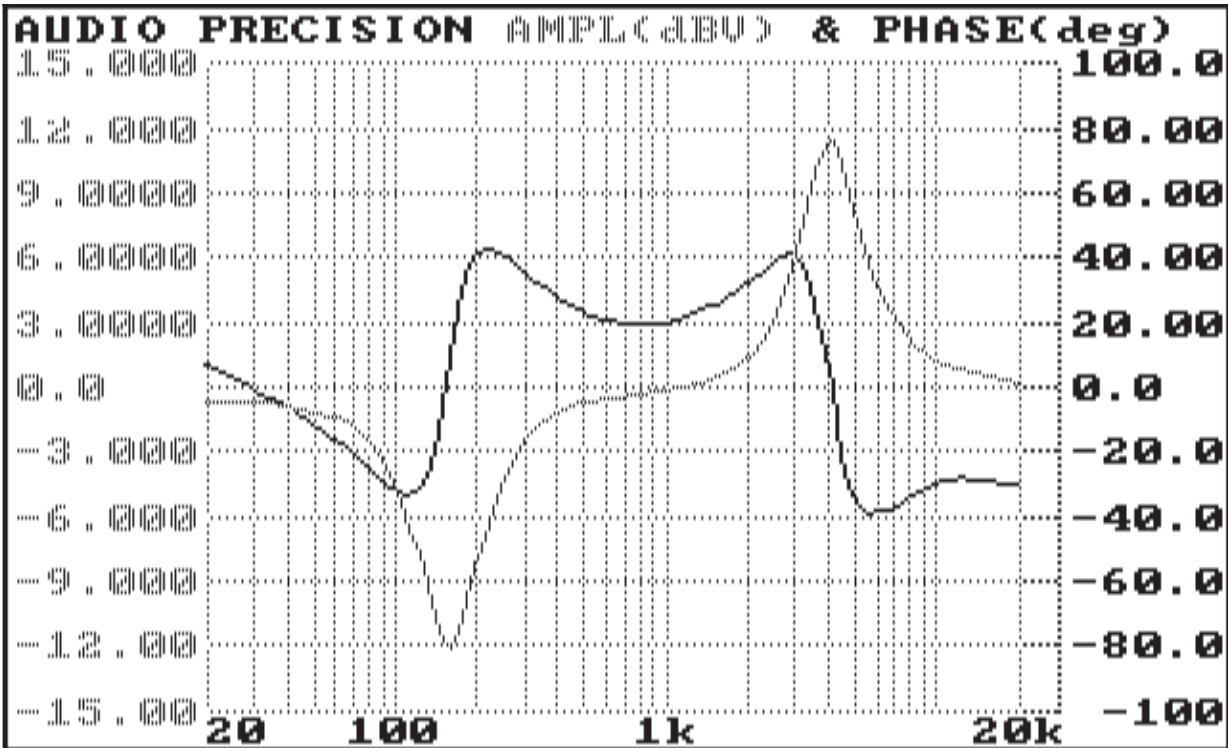

Figure 11-4 Sample Graph from CGA Color-Graph Mode

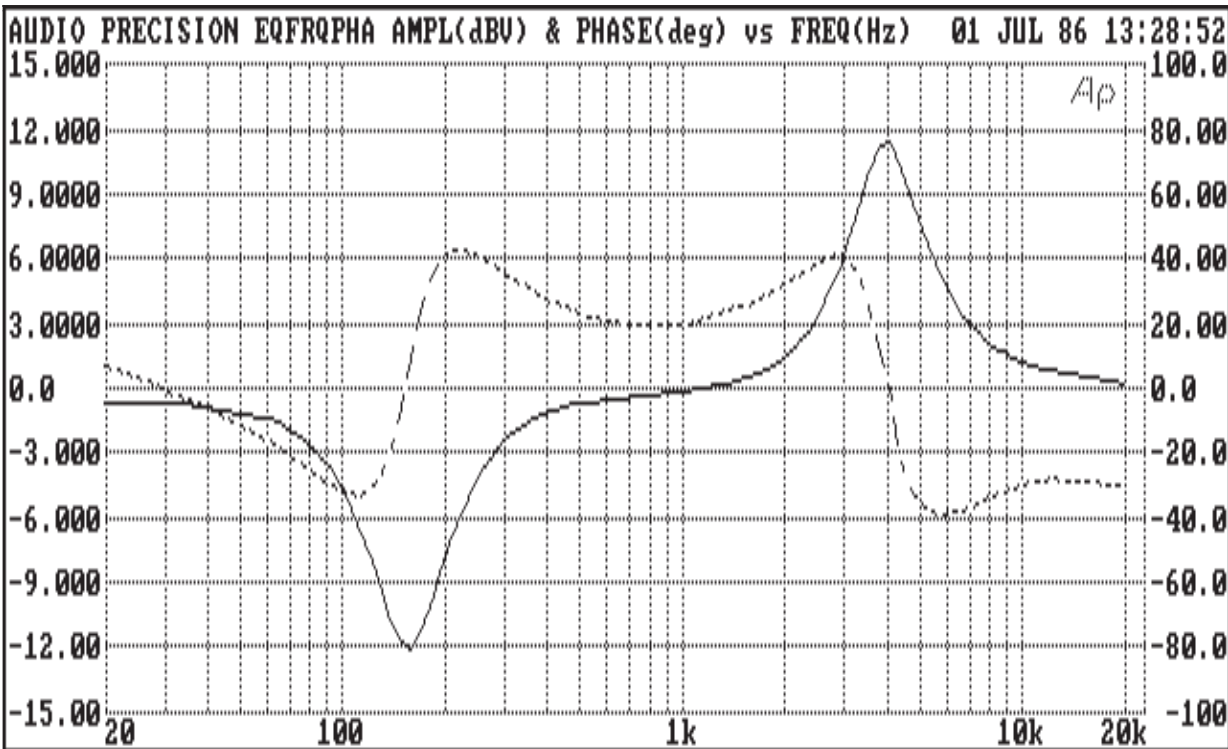

Figure 11-5 Sample Graph from Mono-Graph Mode, CGA Display System

pler to interpret when two variables are plotted onto the same graph, since each is plotted in a different color.

When you are using a color display but printing hard copy with a monochrome printer, you will probably wish to change the DISPLAY selection to MONO-GRAPH before doing the printout in order to have the additional information, solid line vs dashed line data discrimination, and higher resolution (if CGA display system) on the hard copy. See Figure 11-5 and Figure 11-4 to compare printout of the same graph on a CGA system with the DISPLAY in MONO-GRAPH versus COLOR-GRAPH.

DISPLAY TABULAR will produce a tabular listing on screen as a test runs, showing the independent value and the one or two measured values, plus any out-of-limit readings if limit files are attached to the test (see the ACCEPTANCE TEST LIMITS chapter). Tabular display is automatically selected if single-point measurements are made using either the GEN NONE or ANLR NONE selections for SOURCE-1.

DISPLAY NONE is intended principally for production test or other applications with non-technically-skilled operators who would not be able to interpret either graphic or tabular displays. The screen will be blank except for a message showing that the test is in progress or has completed. DISPLAY NONE also slightly shortens test time.

11.5. Running Tests

To make a sweep test and graph, press function key <F9> or <Esc> Run Test. You may interrupt a sweep to return to the panel by pressing the <Enter> key. A sweep may be interrupted and re-started onto the same graph by pressing key <F9>. You can cause a sweep to pause by operation of <F10> and to resume by another operation of <F10>. The grid can be pre-drawn but actual testing delayed by pressing <F9>, followed immediately by <F10>; this permits synchronizing to some external signal source such as a compact disk or tape player, by not starting actual data acquisition until the test tones begin on the device being tested. <F7> (or <Esc> Run

Graph) will retrieve the data of the most recently made test, even if you have gone to the panel and changed measurement or graphic parameters in the meantime. <F9> will then run the test again.

11.6. Graphic Cursors

With a graph displayed on screen (except with CGA color displays), pressing either the left or right arrow key will cause a graphic cursor and numeric display areas to display on screen. These numeric display blocks show the exact value(s) at the intersection of the cursor and the DATA-1 (and DATA-2, if used) curves on screen. The right-hand numeric display shows the exact horizontal location of the cursor (independent variable in most cases). The left-hand numeric display is the vertical intersection of the cursor with the DATA-1 display line. If DATA-2 (or HOR-AXIS or STEREO) is in use, the center numerical display shows the value of that variable.

The left arrow causes the cursor to first appear at the right edge of the screen, then move to the left (downwards numerically) through the data points. The right arrow causes the cursor to appear at the left edge and move upwards through the display. The cursor will move to and display only actual data readings; it does not interpolate between data points. Holding down the <Ctrl> key while pressing the arrow keys (in the numeric keypad only, not the separate arrow keys on 101-key keyboards) causes the cursor to move in steps of five data points. Holding down the <Shift> key while pressing the arrow keys (in the numeric keypad only, not the separate arrow keys on 101-key keyboards) causes the cursor to move in steps of twenty data points. Pressing <Home> will cause the cursor to jump to the extreme left end of the screen. <End> jumps the cursor to the extreme right end.

To remove the cursor from the screen, <Esc> to the menu, then press <F7> for a re-plot.

11.7. Re-Plotting to Improve the Graph

A key advantage of System One software is that data is stored in memory as absolute, floating point numbers rather than as graphs or screen positions (with the exception of Image Save mode, described below). This means that after a test is made (or even stored to disk and later retrieved), it can be freely re-plotted with different units, changes in log-lin choice, and changes in the graph coordinates until the best graphic presentation is obtained.

For example, a test of distortion versus frequency may have been made in which the distortion line ran off the top of the graph during the test. Further thought may also lead the test engineer to the conclusion that he would prefer to display distortion in dB below fundamental rather than percentage. He can return to the panel, change units on the SWEEP (F9) DEFINITIONS panel from % to dB, choose a new value for GRAPH TOP greater than the highest reading obtained, and press <F7> for a re-plot with the new graphic selections. The START and STOP frequencies can be changed to zoom in on a particular part of the spectrum, or the GRAPH TOP and BOTTOM values can be changed to position the measured data as desired. The re-plot capability is commonly used to make the graphic coordinates identical for two tests done at different times, so that they may be printed out for use in a report where the formats should be identical or overlaid via Image Save (see below) for comparison.

11.8. Dual Sensitivity for Same Variable

One measured parameter may be displayed with two different graphic sensitivities by selecting it at both DATA-1 and DATA-2, but using different GRAPH TOP and BOTTOM values. For example, assume that it is desired to sweep the frequency response of a bandpass filter and to display both the nose shape to 3 dB bandwidth, and also the skirt shape and 60 dB rejection. Select AMPLITUDE as the main voltmeter function (READING) and select RDNG at both DATA-1 and DATA-2. To display the nose shape with the solid (green) line, select 0.5

dBr and 3.5 dBr as GRAPH TOP and BOTTOM for DATA-1. To display the skirts and 60 dB bandwidth with the dashed (yellow) line, select 0 dBr and 60 dBr as GRAPH TOP and BOTTOM for DATA-2. Set the generator frequency to the filter center frequency and press F4 to normalize the dBr units to the peak response. Set the generator sweep frequency limits appropriately at SOURCE-1, and press <F9> for a single sweep which will display in two sensitivities. Note that this mode does not require separate readings to be taken for DATA-1 and DATA-2; System One software will use the same measurements for both displays.

11.9. Multiple Sweeps

Consecutive operations of <F9> can create any number of multiple sweeps on screen. This is typically done while changing parameters of the device under test between sweeps. Examples include response sweeps of an equalizer at different settings, or a BANDPASS (third octave) sweep of the noise spectrum of a cassette tape recorder while comparing several types of noise reduction. Only the most recent sweep data is retained in memory if each sweep is started with the <F9> key, and all are displayed with the same color even with EGA and VGA display systems.

When it is desired to store several consecutive sweeps in memory and save them all to a .TST file, the <Ctrl><F9> key combination should be used to start each sweep after the first one. Sweeps started with <Ctrl><F9> do not erase the previous data as <F9> sweeps do, but append the new data onto the bottom of any existing data. Note that the Maximum Data Points parameter shown on the HELP panel still governs the number of points which can be saved or re-graphed via <F7>. If Maximum Data Points is 500, for example, and 99-step (100-point) sweeps are being made, only the first five sweeps can be re-displayed or saved into a .TST file.

Starting each successive sweep with <Ctrl><F9> will also cause each of the first four sweeps to be displayed with a different color on EGA and VGA

displays. If more than four sweeps are made with the <Ctrl><F9> keys, the same four colors will repeat in succession.

When the graph cursor is used on a file with multiple sweeps stored by use of the <Ctrl><F9> keys, the cursor will travel through the sweeps one by one. The <Home> key can be used to jump to one end of the data and the <End> key to the other.

A similar result to operations of the <Ctrl><F9> key can produce a multi-sweep screen display of .TST files even if the tests were separately run and saved. This is accomplished via the APPEND TEST and APPEND DATA features. APPEND TEST will append the data from the specified .TST file onto the bottom of any data presently in memory. APPEND DATA does a similar thing, but from a specified .DAT file. The data from any number of previously-saved tests can thus be brought into memory for display or to be re-saved as a composite, multiple test file. With EGA and VGA systems, up to four different colors will be used to display the multiple data sets, as with <Ctrl><F9>.

Note that certain precautions must be taken if any of the test data is not in absolute units. If data in the file specified during APPEND TEST is in dBr units, for example, it will be re-computed against the dBr REF value presently on the panel when it is loaded. Similarly, dBm data will be re-computed against the dBm/W REF value on the panel when it is loaded. If it is instead desired to preserve the absolute amplitude relationships of the data in the various files being appended, they should each be changed to an absolute unit and re-saved to disk before the APPEND TEST operation is done.

11.10. Repeated Sweeps

It is sometimes desirable to make repeated sweeps, erasing the data from the grid at the end of each sweep to avoid clutter. <Alt><F9> will trigger a sweep, erase, and repeat operation which is convenient while making adjustments to the device under test. This repeat cycle may be terminated by pressing <Esc>. Note that this mode uses any im-

age stored in the Image Save buffer, if graphically compatible, or writes over it if incompatible; see the Image Save section below for more information. When it is desired to graph any attached limits via the <Alt><F7> feature before entering the sweep, erase, and repeat operation, the <Alt><F8> command must be used to store the limits into the image buffer. Thus, the keystroke sequence to automatically graph limits, store their image, and start a repeating sweep cycle is:

<Alt><F7> <Alt><F8> <Alt><F9>.

With EGA and VGA display systems, the stored image will be monochrome even when normal displays are in color.

Sweep-erase-repeat mode (<Alt><F9>) and Image Save mode (<Alt><F8> and <F8>) are not functional if the software was started with the /8 command line option to conserve memory.

11.11. Stereo Mode, Nested Sweeps, and Measurements on the Horizontal Axis

The DATA-2 line contains three other choices for measurement and plotting flexibility. STEREO mode permits two-channel devices to be tested more efficiently. SOURCE-2 permits two types of parameters to be swept in a test, with one "nested" inside the other. For example, generator frequency may be swept from 20 Hz to 20 kHz at one amplitude; the amplitude may then be automatically increased by a specified amount, another frequency sweep made, the amplitude increased again and frequency swept again, etc. HOR-AXIS mode on the DATA-2 line permits two measured values to be plotted against one another, rather than plotting both as dependent variables versus an independent variable such as generator amplitude. Each of these modes is discussed below.

11.11.1. Stereo Mode

Selecting STEREO instead of DATA-2 produces two different types of operation, depending on whether an EXTERNAL sweep or a GEN-ANLR-SWI-DCX-DSP sweep has been selected at SOURCE-1.

11.11.1.1. Generator-Based Stereo Sweeps

When a generator (or analyzer BPBR filter or switcher or DCX) sweep has been selected as SOURCE-1 and STEREO mode is selected, System One will automatically make two successive sweeps of the stimulus. The first sweep will be made with the generator output channel selection and analyzer input channel selection as set up on the GENERATOR and ANALYZER panels. This first sweep will be plotted in the usual DATA-1 conventions (solid line monochrome, green line color, 2nd column if table). At the conclusion of the first sweep, System One will automatically switch generator output channels and analyzer input channels as required to perform the identical test on a second channel or device, plotting the results in the usual DATA-2 conventions (dashed line monochrome, yellow line color, 3rd column if table). Both sets of data are stored in the same xx.TST file and will be re-graphed simultaneously when <F7> is pressed, even though they were measured sequentially. Both channels may have limits files attached to them, and the limits need not be the same (see ACCEPTANCE TEST LIMITS chapter).

The same units would normally be used for both channels of a stereo device. The COMPUTE EXCHANGE menu command or its "shorthand" equivalent, <Alt><X>, can simplify this. At DATA-1, select the desired parameter (RDNG, LEVEL, etc.) and enter the desired GRAPH TOP and BOTTOM, LOG-LIN selection, and # DIVS. Move the cursor to the STEREO (DATA-2) line and select the same parameter (RDNG, LEVEL, etc.). Press <Alt><X> and the GRAPH TOP and BOTTOM, LOG-LIN, and # DIVS will be automatically copied into these fields. Since COMPUTE EXCHANGE (<Alt><X>) also exchanges any data in the DATA-1 and DATA-2 fields, it may be desirable to press <Alt><X> a

second time if the test has already been run to restore the data values to their original columns. See the COMPUTE EXCHANGE description in the MENU chapter for more details.

The two channels may also have their units, GRAPH TOP, and GRAPH BOTTOM selected independently. This independent selection of GRAPH TOP and BOTTOM for the two channels permits either overlaying of the two channels or deliberately separating them by any desired amount to prevent one line from obscuring data of the other. For example, a stereo amplifier frequency response sweep might be made with +1.0 dBr and -1.0 dBr as GRAPH TOP and BOTTOM for DATA-1, but +0.9 dBr and -1.1 dBr chosen on the STEREO (DATA-2) line to cause a 0.1 dB offset between the two sets of data. When different GRAPH TOP and BOTTOM values are selected for the second channel, a separate set of calibration marks will appear alongside the right margin of the graph. When both channels use the same calibration, no calibration marks will be displayed on the right.

If A was selected on the GENERATOR panel as the output configuration of a STEREO sweep, B will be automatically selected during the second sweep. Similarly, if B were selected on the panel, A will be used during the next sweep. If the generator output configuration is set on the GENERATOR panel to OFF, A&B, or A&-B, no generator change takes place between the two sweeps in STEREO mode.

Whichever analyzer input channel is selected at the top of the ANALYZER panel will be interchanged with the other channel on the second sweep in STEREO mode. At the CHANNEL-A and CHANNEL-B INPUT lines further down the ANALYZER panel, no change will be made between sweeps if both channels have INPUT or GEN-MONITOR selected on the panel. If, however, one channel is set to GEN-MONITOR and the other to INPUT, the selections will be interchanged during the second sweep.

These interchange conventions not only permit stereo device tests such as frequency response or thd+n versus frequency, but also support stereo cross-

stalk measurements and tests of input-output phase variations on stereo amplifiers. With units with serial number SYS1-20300 and higher, the 2-CHANNEL and CROSSTALK modes present improved alternate methods of making frequency response and crosstalk measurements on stereo devices.

11.11.1.2. External Stereo Sweeps

External sweep mode is commonly used with uncontrollable (or only semi-controllable) signal sources such as pre-recorded test tapes, test compact discs, or a network feed from a continuously-cycling step tone oscillator. Most such sources are designed for slow, manual methods of audio measurement and thus dwell at each frequency for times ranging from 10 or 20 seconds to one minute. One to three seconds is typically adequate for System One to measure response or phase or distortion on both channels of a stereo system. Thus, the logic behind STEREO mode with EXTERNAL sweep is for a given parameter to be measured on both channels during a single pass.

In this mode, System One will measure the specified SOURCE parameter (frequency for EXTERNAL FREQUENCY sweeps, amplitude for EXTERNAL LEVEL sweeps) from the ANALYZER-panel-selected channel until it settles within definitions of the SWEEP SETTling panel as described later in this section. System One then measures the parameter specified at DATA-1 until the data is settled, automatically toggles the analyzer input to the opposite channel, and measures the DATA-2 parameter until it settles. Following settling on the second channel, System One switches back to the first (ANALYZER panel-selected) channel and waits for the SOURCE parameter to change by more than the SPACING value entered at the bottom of the SWEEP (F9) DEFINITIONS panel; it then repeats the cycle. Both channels will be plotted simultaneously, even though the measurements are actually being made in sequence.

Crosstalk and stereo separation from external sources can be measured by two methods with hardware after serial number SYS1-20300 and one method with hardware prior to s/n SYS1-20300. With either hardware version, if BANDPASS mode

SWEEP (F9) DEFINITIONS		
DATA-1	ANLR	RDNG
GRAPH TOP	+6.00	dBu
BOTTOM	+2.00	dBu
# DIUS	0	LIN
STEREO	ANLR	RDNG
GRAPH TOP	+6.00	dBu
BOTTOM	+2.00	dBu
# DIUS	0	LIN
SOURCE-1	ANLR	BPBR
START	.999000	kHz
STOP	1.00100	kHz
# DIUS	0	LIN
# STEPS	1	
TABLE	OFF	
DISPLAY	MONO-GRAPH	

Figure 11-6 Sweep Test Panel for Channel Balance, Original Hardware

is selected at the top of the ANALYZER panel, System One will measure the incoming signal frequency and steer the bandpass filter to that frequency while measuring the panel-selected channel. The *signal-driven channel* must thus be selected on the ANALYZER panel. After settling, System One switches to the alternate channel, keeping the bandpass filter fixed at the same frequency. The driven (panel-selected) data is displayed with DATA-1 conventions and the non-driven channel is displayed with DATA-2 conventions. The actual crosstalk or separation is the difference between the two lines on the graph. Use of bandpass mode permits measurement of crosstalk below wideband noise level on playback-only tape machines such as videotape recorders.

With System One s/n SYS1-20300 or higher, STEREO mode is no longer necessary when measuring crosstalk or separation from EXTERNAL sources. Instead, CROSSTALK function may be selected and the desired unit (usually dB or X/Y) selected on the READING line. The *non-driven* channel must be

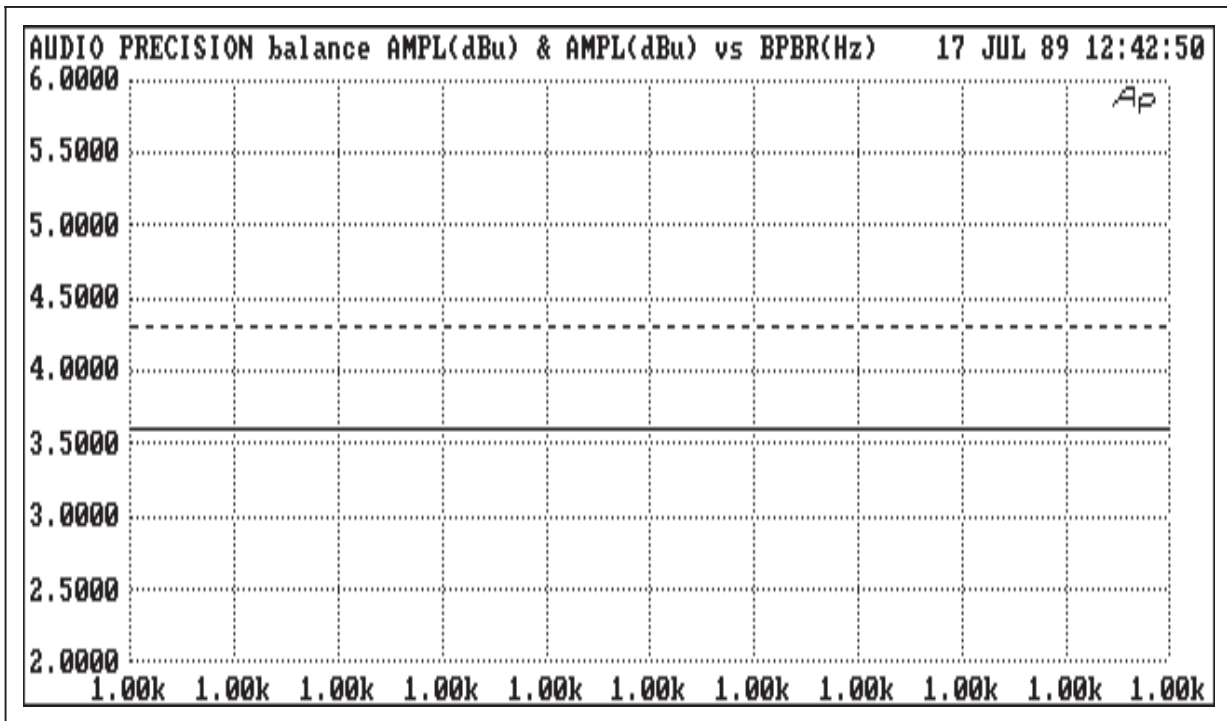

Figure 11-7 Typical Display, Channel Balance Adjustments with Original Hardware

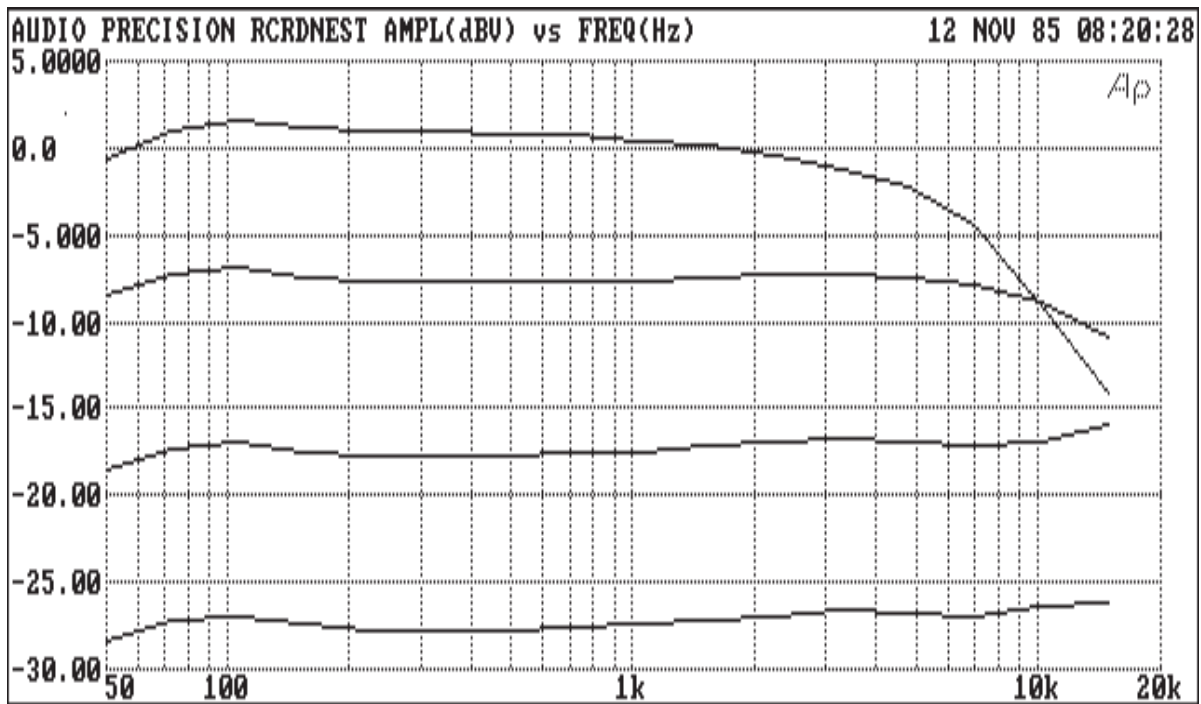

Figure 11-8 Nested Sweep Frequency Response of Cassette Recorder at Four Amplitudes

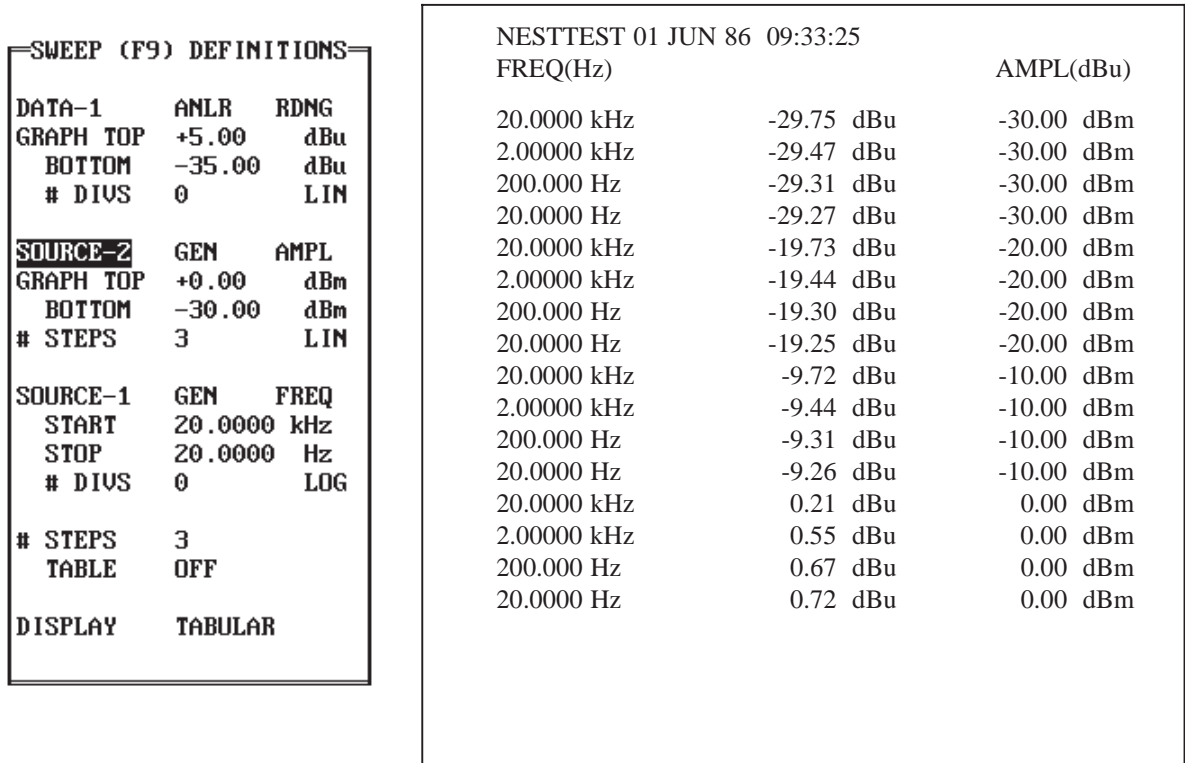

Figure 11-9 Sweep Test Definition Panel and Table Display, Nested Sweep

selected on the ANALYZER panel, since CROSTALK function automatically connects the LEVEL meter and frequency counter to the alternate channel and the principal (READING) voltmeter, in band-pass mode, to the channel selected on the ANALYZER panel. By selecting RDNG as DATA-1, the crosstalk will be plotted as the EXTERNAL sweep progresses. No channel toggling is involved and the graph plotted will not need further correction in the case of non-flat frequency response, since each measurement is the difference between the amplitudes on the two channels.

11.11.1.3. Channel Balance Adjustments

Channel balance adjustments, to cause equal levels from both channels of a stereo system, are a frequent need. One example is a head height adjustment on a stereo tape recorder, while playing a reference tape.

With units of serial number SYS1-20300 and higher, 2-CHANNEL function provides a superior way of making such balance adjustments. 2-CHANNEL function connects the READING voltmeter to the selected channel and the LEVEL voltmeter to the alternate channel. They may then both be displayed simultaneously in bar-graph mode by selecting RDNG and LEVEL as DATA-1 and DATA-2 and pressing the <F2> key. Alternately, dB or X/Y may be selected as the READING unit, RDNG selected as DATA-1, <F2> pressed, and the balance adjustments made for zero dB (or a 1:1 ratio).

With hardware below serial number SYS1-20300, channel balance adjustments can be facilitated with a repeating one-step ANLR BPBR "sweep" at SOURCE-1, with STEREO mode instead of DATA-2. See Figure 11-6 for the panel setup. The <Alt><F9> key will start a continuous sweep-erase-repeat sequence. The generator and analyzer channel selection will be toggled at each step, with the A channel data plotted as a solid (green) line and the B channel data as a dashed (yellow) line. These two

input channels will be alternately measured and plotted as often as the **SETTLING** panel conditions permit. Bandpass measurement mode is not used, so the measured data is not affected by the filter “sweep”; this is merely a method of obtaining rapid channel switching and display of both channels. The device under test is then adjusted until the amplitudes on the two stereo channels are equal. See Figure 11-7 for a typical display during such adjustments.

11.11.2. Plotting Measurements on the Horizontal Axis

The most common graphic format in System One is with the independent variable (typically generator frequency, generator amplitude, or time) along the horizontal axis and one or two measured parameters calibrated along the vertical axis. For certain measurements, it is desirable to plot one measured parameter versus another as an x-y plot. For example, it is very useful to provide an amplitude sweep at a fixed frequency to the input of an amplifier or tape recorder while measuring both distortion and amplitude at the device output. It may then be desired to plot distortion versus output amplitude of the device, not showing the stimulus amplitude at all. This is accomplished by changing from **DATA-2** to **HOR-AXIS** at the center of the panel. The analyzer function selection on this line will be plotted horizontally on the graph, with the parameter selected as **DATA-1** plotted vertically.

11.11.3. Nested Sweeps

The **SOURCE-2** selection on the **DATA-2** line offers the capability of nesting a generator amplitude sweep inside a generator frequency sweep or vice-versa; nesting a generator frequency sweep inside a scan through switcher positions; nesting an analyzer bandpass filter sweep inside a generator frequency sweep; nesting a frequency sweep inside steps of control voltage (**DCX-127 DCOUT**) of a VCA, and other such combinations. An example graph of a cassette tape deck measurement with nested sweeps is shown in Figure 11-8, consisting of four 50 Hz to 15 kHz sweeps, each at an amplitude ten dB higher

than the previous. On an EGA or VGA color display, each sweep in the nest will be displayed with a different color, up to four sweeps. The colors will then repeat.

Nested sweeps are created by use of the **SOURCE-1** line and the **DATA-2/SOURCE-2** line of the **SWEEP (F9) DEFINITIONS** panel. If a **FREQUENCY** sweep has been selected for **GEN** on the **SOURCE-1** line, it can be nested inside an amplitude sweep by changing from **DATA-2** to **SOURCE-2**, and selecting **GEN AMPL** to the right of **SOURCE-2**. Enter the desired amplitude for the first sweep into the **GRAPH BOTTOM** field and the amplitude for the last sweep into the **GRAPH TOP** field. Use the **# STEPS** field to select the number of steps of amplitude which will be made between the first and last sweeps, and select **TYPE LOG** or **LIN** to control the type of progression between those amplitudes. For example, if **GRAPH TOP** is 0 dBm, **GRAPH BOTTOM** is -30 dBm, **TYPE** is **LIN**, and **# STEPS** is 3, the result will be four sweeps through the frequency range selected on the **SOURCE-1** line—the first at a generator output amplitude of -30 dBm, the second at -20 dBm, the third at -10 dBm, and the last at 0 dBm. See Figure 11-9 for a **SWEEP (F9) DEFINITIONS** panel set up for a nested sweep with the example just described, and for an example of the screen display if **DISPLAY TABULAR** were selected. Note that with the **TABULAR** display (or when examining data in the **Edit Data** mode), the third column indicates the value of the “outer loop” of the nest, as controlled by the **SOURCE-2** parameters.

GEN AMPL can be selected as **SOURCE-1** and **GEN FREQ** as **SOURCE-2** to nest an amplitude sweep inside a frequency sweep. Similarly, an amplitude or frequency sweep can be nested inside a switcher scan to perform the same test on many channels of a multi-channel device; see the **SWITCHER** chapter for more details.

A key difference between a nested sweep and a series of individual tests combined via **Image Save** (see below) is that all the data from all sweeps in a nested sweep are stored in one standard **xx.TST** file. The multiple sweeps can thus all be retrieved with a single **Load Test** operation and re-plotted with a sin-

gle <F7> keystroke, and after-the-fact changes in graphic units and coordinates can be made just as they can with a single sweep. Since a nested sweep is a standard xx.TST file, the total number of points in all the nested sweeps cannot exceed the Maximum Data Points value (viewable on the HELP panel).

When the graph cursor is used with a nested sweep test, the right-hand numeric display will show the SOURCE-2 value for each sweep while the left numeric display shows the actual data value.

With the normal start-up procedure and a large-memory computer, the MAXIMUM DATA POINTS value is 1,089 points. Thus, a 30 step frequency sweep with a 30 step amplitude sweep nested inside it could be run (though it would take quite a long while to run), but a 50 step frequency sweep could not have more than approximately 20 amplitude steps nested inside it. When more than 1089 total points are required, S1 software can be loaded with the /B option to specifically set buffer sizes as needed. See the "Controlling Memory Usage" section of the CREATING YOUR CUSTOM SOFTWARE START-UP PROCESS chapter for more information.

If the data from a nested sweep (or APPEND TEST or APPEND DATA operations) is examined with the Edit Data capability, it will be seen that the end of one sweep and beginning of the next is signified with an artificial data row consisting of a duplication of the ending value of the independent variable in the first column and an extremely large negative number (-1.000E32) in the second and third columns. When graphing data, this row signifies to System One that it should move (but not draw a vector) to the following point and then continue plotting data. With EGA and VGA color displays, the trace color is also changed each time this row is reached. This "move but don't draw" capability may be useful in applications other than nested sweeps, and a data row of this description could be entered into any file in Edit Data mode to obtain the same function.

A useful application of an amplitude sweep nested inside a frequency sweep is testing compressors and other processors such as noise reduction units. Select AMPLITUDE as the main MEASURE READING on the ANALYZER panel and RDNG at DATA-1. Select GEN FREQ at SOURCE-1 with the desired start and stop frequencies. A family of curves of frequency response at levels from below the compression threshold to levels well into compression can then be run as one test by selecting SOURCE-2 GEN AMPL and properly selecting the GRAPH TOP and BOTTOM amplitudes and the # STEPS.

A frequency sweep nested inside an amplitude sweep is useful in determining the maximum output level (MOL) of a tape recorder. The SOURCE-1 area is used to select a GEN AMPL sweep and set the amplitude limits and number of steps for a test which will show the tape and tape machine distortion. The DATA-2 line can then select a GEN FREQ sweep with, for example, a LOG TYPE, 20 Hz for GRAPH BOTTOM, 20 kHz for GRAPH TOP, and 3 for # STEPS. The test will then run four consecutive amplitude sweeps, at 20 Hz, 200 Hz, 2 kHz, and 20 kHz.

11.12. Overlaying Graphs

As noted earlier, repeated operations of the <F9> key can build up any number of sweeps on screen when the difference between them results from changes to the device under test, such as testing a number of different settings of an equalizer. <Ctrl><F9> can be used if they are all to be saved or re-graphed via <F7>. Append Test can be used to make composite graphs of the results of two or more different tests already saved.

The graphics Image Storing capability can be used to make composite graphs, with a different set of advantages and disadvantages compared to the <Ctrl><F9> and Append Test method.

The image store and retrieve capability involves the use of two additional controls:

- <Alt><F8> (hold down the <Alt> key while pressing the <F8> key) to store graphics image of the present screen into computer memory
- <F8> to retrieve the stored graphics image to the screen

After an image has been brought to the screen, the <F7> key will plot data from memory onto it if the graph coordinates match. Similarly, the <F9> key will cause new test data to plot onto the image if the graphic coordinates match. Matching graphic coordinates refer to the sweep start and stop points, log-lin selection on horizontal and vertical axes, units on horizontal and vertical axes, and graph top and bottom lines. Even small deviations from the saved image will prevent the graphs from overlaying. Typical problems include having a DATA-1 or DATA-2 LOG selection but with dB units with a zero or negative GRAPH TOP or BOTTOM. In this case, a linear plot will result but overlay will be denied if one test is set for LIN and the other for LOG. If the stored image and the panel do not match in graphic coordinates, a new graph will be drawn; the stored image still remains in memory to be retrieved later with the <F8> key.

With VGA and EGA display systems, the stored image will be monochrome even though COLOR-GRAPH was selected for DISPLAY. This limitation was necessary due to the large amount of memory required to store high-resolution color displays with a large number of available colors.

The image store function will not work if S1.EXE was loaded with the /8 option in order to conserve memory.

An example may be the best way to explain the use of image store. Assume that monthly tests have been made for four months of the frequency response of a tape machine, and it is desired to see all four graphs overlaid to look for deterioration trends. Also assume that all four monthly tests were made by loading the same xx.TST file as a setup file, running the test, and then saving under filenames such as RESP_JAN.TST, RESP_FEB.TST,

RESP_MAR.TST, and RESP_APR.TST. The tests will thus all have identical graphic coordinates, since they were made with the same setup file.

First, Load Test RESP_JAN.TST and use <F7> to graph the data. Press <Alt><F8> to store the graphic image to computer memory. Then, <Esc> Load Test RESP_FEB.TST, press <F8> to bring the stored graphic image (January data) to the screen, and press <F7> to plot the stored test from February onto the stored graphic image. When it has plotted, press <Alt><F8> to store the composite combination of the two to computer memory. Similarly, <Esc> Load Test RESP_MAR.TST, bring the composite image to screen with <F8>, plot the March data onto it with <F7>, and store the new three-graph composite back to computer memory with <Alt><F8>. Any number of matching-coordinate graphs can be combined in this fashion, with the resulting image printed if desired.

Note that an error message "Saved Image Not Compatible With Graphics Mode" will be obtained in a display system when <F8> is pressed if the stored image (color graph or monochrome graph) format does not match the current panel display mode (display color-graph or display mono-graph).

The APPEND TEST and APPEND DATA commands (see the MENUS chapter) provide an alternate approach to creating composite graphs. The APPEND commands may be easier to use since they do not require the identically-matched graphic coordinates and graphics modes of Image Store. After appending several sets of data, the graphic coordinates or mode (color-monochrome-table) may be changed and the entire set of tests re-graphed via <F7>. Image Store, in contrast, permits no changes after the first image is stored. However, APPEND TEST and APPEND DATA will re-interpret any data not saved in absolute units (dBm and dB_r, for example), while Image Store is only a graphic technique which will not tamper with data or references. Furthermore, Image Store has no "Maximum Data Points" limitations and will thus support overlay of any number of tests with any number of points per test.

11.13. External Sweeps

EXTERNAL sweep mode uses as the independent variable external signals which step or continuously vary in frequency or amplitude from high to low or low to high, or which go through a repetitive cycle. The START and STOP values selected on the panel in EXTERNAL sweep mode determine the graphic horizontal limits and calibration, and the direction in which plotting will take place. Measurements will be made (but not plotted) outside those values if the external test source includes tones outside that range. If the external signal moves in the opposite direction to that implied by the choice of START and STOP values, data will be taken but no line will be plotted between those points. This feature permits EXTERNAL sweep mode to be used even with continuously recycling sweeps without any re-trace line being plotted across the graph.

Measurement of AMPLITUDE or LEVEL, FREQUENCY, and PHASE may be made on either stepped or continuously analog-swept (glide tone) external signals. Select EXT SOURCE 1 SAMPLE on the SWEEP SETTling panel for continuous analog-swept (“glide tone”) signals so that the external source (frequency or level) will be measured even though no two consecutive values agree. THD+N tests require a stepped external signal which dwells at each value for approximately one second or more, depending on the sweep settling parameters selected. The exact required dwell time depends on the signal frequency (more time required at low frequencies), reading rate, whether there is an off period with no signal between tones (more time required because System One will autorange down to the off level, then back up to the signal level), and on the parameters selected on the SWEEP SETTling panel; see the SWEEP SETTling section below.

EXTERNAL sweep performs the following functions (assuming a frequency sweep):

1. Measures frequency with the analyzer counter until the frequency measurements are stabilized within the conditions specified on the SWEEP SETTling panel.

2. Waits for the specified SETTling DELAY.
3. Verifies that signal amplitude as measured with the LEVEL voltmeter is above the MIN LVL voltage.
4. Measures the parameters selected by DATA-1 and DATA-2 until data settles.
5. Draws lines on the graph from the previous data point to this data point and sounds the “bell”.
6. Monitors frequency until it changes from the previous frequency measurement by more than the SPACING percentage entered in the SOURCE-1 area; when it does, goes to step 1 and repeats the cycle.

Unless extremely flat frequency response beyond 50 kHz is required during EXTERNAL frequency sweep measurements, it is recommended that the 80 kHz low pass filter or even the 30 kHz or 22 kHz filters be selected. Selecting any of these three low-pass filters also causes a low pass filter prior to the analyzer frequency counter to be selected, which improves the counter’s ability to quickly acquire and accurately measure the signal frequency under noisy conditions. Since EXTERNAL frequency sweep measurements are totally dependent on these frequency measurements to drive the test and calibrate the data, selecting a low pass filter improves both test speed and data quality.

If EXTERNAL LEVEL sweep is selected, it performs the following functions:

1. Measures amplitude with the LEVEL meter until the measurements are stabilized within SWEEP SETTling panel specified conditions.
2. Waits for the specified SETTling DELAY.
3. Verifies that signal amplitude as measured with the LEVEL meter is above the MIN LVL voltage.
4. Measures the parameters selected by DATA-1 and DATA-2 until data settles.

5. Draws lines on the graph from the previous data point(s) to this (these) data point(s) and sounds the "bell".
6. Monitors LEVEL voltmeter amplitude until it changes from the previous measurement by more than the SPACING percentage entered in the SOURCE-1 area; when it does, goes to step 1 and repeats the cycle.

If STEREO is selected instead of DATA-2, the system will first measure and settle the SOURCE value as described in either frequency or amplitude cases above, apply SETTling DELAY, measure and settle the DATA-1 parameter, switch to the alternate channel, again apply SETTling DELAY, measure and settle the parameter selected on the STEREO/DATA-2 line, switch back to the selected channel to verify that the SOURCE is still within its tolerance from the value which started this set of measurements, plot the data, and then monitor the SOURCE for a change greater than the SPACING percentage. If the source parameter was not still within tolerance upon the verification after DATA-2 measurement, the system will plot only DATA-1 on the assumption that the source may have shifted sometime during the DATA-2 measurement.

In the typical test disk or test tape situation of a mid-band reference signal preceding the start of a frequency-stepped or analog-frequency-swept series of tones, select the START and STOP values to imply the direction of frequency sweep which the test signal will take following the reference signal. System One will then measure the mid-band reference tone (unless it is the same frequency as the GENERATOR panel FREQUENCY value), but will not plot the transition from this mid-band value to the starting frequency since it will be opposite to the direction implied by START and STOP selection. If amplitude measurements are to be expressed in dBr units, the <F4> key may be pressed or invoked by a procedure while the reference portion is playing. Test tapes or disks with voice announcements of each frequency or level are typically usable with this mode, since the measurements cannot settle during the voice portions.

Three different modes of external sweep tests may be run, selected by pressing <F9>, <Alt><F9>, or <Shift><F9>. External sweeps begun with <F9> will accumulate data until terminated with the <Esc> or <Enter> key. If, for example, the signal is a continuously recycling frequency sweep, multiple plots will be made until the operator halts the test. If the test tone proceeds in an increasing direction (for example, 50 Hz, 100, 500, 1000, 5000, 15000, 50, 100, etc.), 50 Hz should be selected as START and 15,000 (or 20,000) Hz selected as STOP. Each upwards transition will then be plotted, but the transition (retrace) from 15,000 to 50 Hz will not be plotted since it takes place in the opposite direction to that specified by START and STOP.

If the test is started with <Alt><F9>, a sweep-erase-repeat mode will take place. If the external test signal is a continuously-repeating sweep through the frequencies in the example given above, the graph will be plotted from 50 Hz to 15,000 Hz, no retrace line will be drawn from 15,000 to 50 Hz, and the data line (but not the grid) will be erased when the 50 Hz to 100 Hz transition is plotted. This mode is designed for adjustments to be made while the external signal repeatedly sweeps, eliminating the clutter which would result in <F9> mode with all previous graphs remaining on the screen. Typical applications are amplitude measurements from a three-head (simultaneous record-playback) tape recorder while adjusting bias or equalization, or phase difference measurements between two tracks of a tape recorder in playback mode while adjusting head azimuth. The sweep-erase-repeat mode will continue until terminated via <Esc> or <Enter> key. Sweep-erase-repeat mode will not function if S1.EXE was started with the /8 option to conserve memory.

The <Shift><F9> mode of external sweep is designed for use during procedures. It differs from the two other external sweep modes in that it automatically terminates the test, and will thus move on to the next test in a procedure, whenever the external signal makes a frequency transition *in the opposite direction to that implied by the START and STOP frequencies, to the frequency set in the GEN FREQUENCY field on the GENERATOR panel*. This mode is intended for use with known external sig-

nals, such as a test tape previously recorded by use of System One, or with a test compact disc where the frequency of the next tone following a frequency sweep or set of steps is known.

When making a test tape for this mode with System One, a generator-based frequency sweep will normally be set up on the SWEEP (F9) DEFINITIONS panel; it is common to leave the GENERATOR panel FREQUENCY set at a mid-band value such as 1 kHz. If the tape is allowed to continue recording for another few seconds following completion of the sweep, the result will be a period of steady tone at the GENERATOR panel frequency. It is the frequency-reversal from the sweep end point to this steady tone at the GENERATOR panel frequency which then serves as the signal to halt the <Shift><F9> external sweep during execution of a procedure. If the test source is already created (such as a compact test disc with a series of tracks at different frequencies), the signal frequency on the track following the last of the frequency-step series should be determined and entered as the GENERATOR panel FREQUENCY when creating and saving the EXTERNAL sweep test for use in a procedure.



12. SWEEP SETTLING

12.1. The Settled Reading Problem

Automated measurement hardware is capable of generating rapid streams of questionable or totally erroneous data. This is due to the fact that reading rates and data transfer rates of ac measurement instruments are normally faster than the time required for the analog portions of the instrument to settle to specified or ultimate accuracy. Furthermore, many audio devices being tested have even longer settling times; compressors, limiters, and other types of signal processors can have decay or release times of several seconds. Three-head tape recorders, in record-playback mode, have a time delay of typically hundreds of milliseconds between the heads, synchronous satellite up-and-down links have a delay of approximately 250 milliseconds, and audio time de-

lay units may have delays of seconds. A knowledgeable audio test engineer using manual instruments allows for settling times and time delays. Each time he changes stimulus, he waits for the indicated measurement to stabilize before he writes down the number. System One software performs similar actions to guarantee the integrity of the measurements taken. The engineer setting up System One panels and creating tests has control over how the system defines a settled measurement, via the SWEEP SETTLING panel.

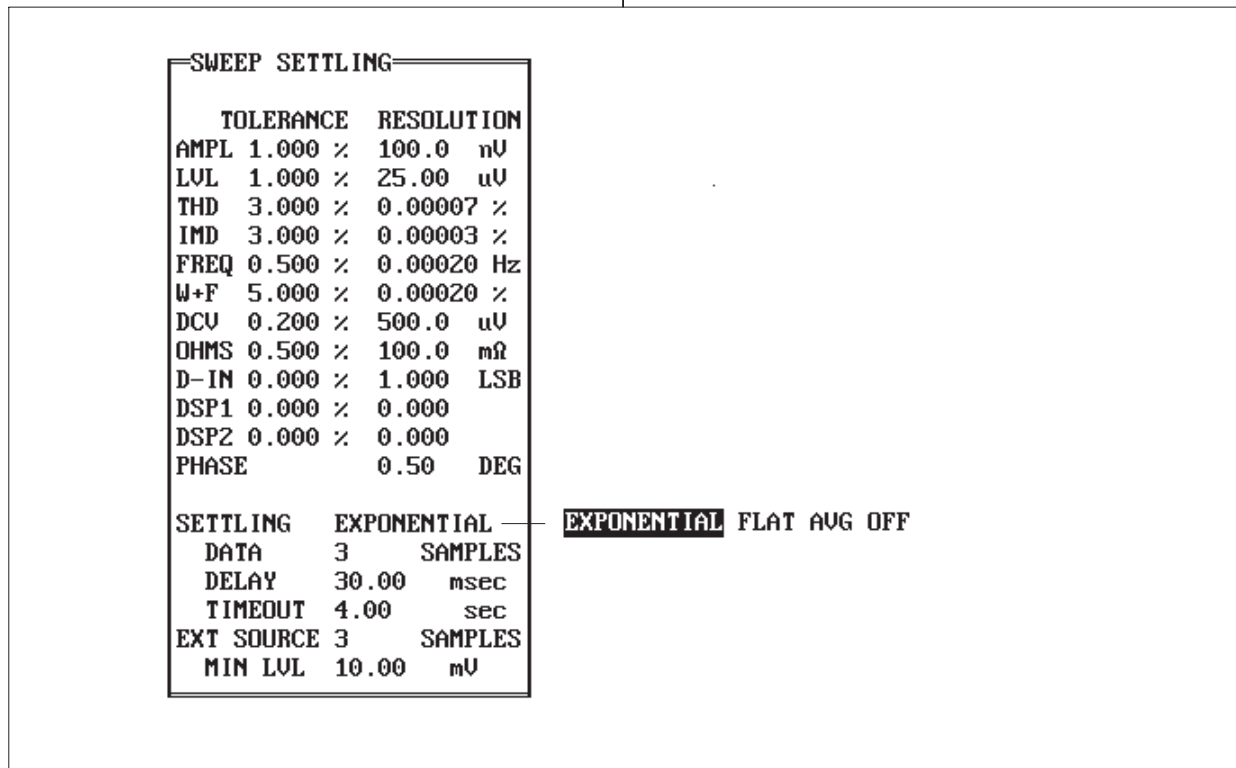

Figure 12-1 Sweep Settling Panel

12.2. Sweep Settling Control Panel

The SWEEP SETTling panel (Figure 12-1) can be interchanged with the panels normally in place via the <Pg Dn> and <Pg Up> keys. <Pg Up> and <Pg Dn> will interchange the entire set of three panel sections on screen (typically GENERATOR, ANALYZER, and SWEEP (F9) DEFINITIONS), with three other lesser-used panels. By using <Ctrl><Pg Up> and <Ctrl><Pg Dn>, it is possible to bring an off-screen panel section from one of the “lower pages” onto the screen in place of the panel section where the cursor is located. The system will rotate through the still-lower off-panel screens, allowing you to produce any combination of panels on screen that you wish. <Ctrl><Home> will return you to the original default combination of GENERATOR at the left, ANALYZER in the center, and SWEEP (F9) DEFINITIONS at the right, with the cursor on the GENERATOR OUTPUT field.

The sweep settling concept is to continually examine the series of measurement samples coming from the hardware. The rate at which the samples arrive is determined by the reading rate selected on the DETECTOR line of the ANALYZER panel. If AUTO is selected on that line, an algorithm will select the reading rate as a function of the present frequency during GEN and ANLR BPBR sweeps. The software makes comparisons between the most recent measurement sample and several immediately-prior samples, and finally accepts the newest measurement sample (and allows the stimulus to proceed to the next value) only when all those comparisons fall within specified limits.

The limits for each major type of measurement parameter are independently determined by a selectable tolerance and/or resolution value. AMPL (amplitude), LVL (level), THD (total harmonic distortion plus noise), IMD (intermodulation distortion), FREQ (frequency), W+F (wow and flutter), DCV (DCX-127 dc voltmeter), OHMS (DCX-127 ohmmeter), and D-IN (DCX-127 digital input) each have both a tolerance and a resolution value; PHASE has only a resolution value. Note that AMPL refers to all amplitude functions of the principal voltmeter—AMPLITUDE, BANDPASS, BANDREJECT, the THD+N function when used with absolute units

such as V, dBU, dBm, dBr, and Watts, and (with units after s/n 20300) CROSSTALK and 2-CHANNEL.

The consecutive number of samples which will be compared is determined by the DATA SAMPLES value. The SETTling line permits selection of three modes of control of the settling process. EXPONENTIAL causes an exponentially-shaped “window”, with height determined by the TOLERANCE parameter, to be applied backwards from the latest data sample. EXPONENTIAL is the recommended selection for most applications, since most transient signals settle in an approximately exponential fashion. FLAT extends the specific TOLERANCE value backwards horizontally and will provide the most-settled (but slowest) data. AVG causes a calculation to be made of the average of the number of samples specified, with the computed average value then plotted and saved. This is particularly helpful with noisy signals. OFF disables the settling function entirely, permitting plots of values such as peak noise, wow and flutter, and phase jitter.

If DATA 6 SAMPLES is selected, each measurement sample will be compared to the five previous samples with the EXPONENTIAL or FLAT “window” defining the comparison standards. If SETTling is EXPONENTIAL and a TOLERANCE of

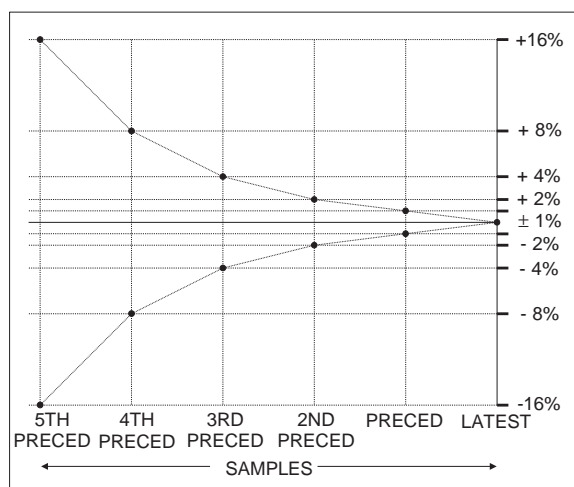

Figure 12-2 Sweep Settling Diagram

1% is specified, as illustrated in Figure 12-2, the most recent data point will be plotted and the stimulus permitted to step to the next value only when:

- the two most recent samples agree within 1%
- the most recent and the second preceding samples agree within 2%
- the most recent and the third preceding samples agree within 4%
- the most recent and the fourth preceding samples agree within 8%
- the most recent and the fifth preceding samples agree within 16%

As with any digital display instrument, digital resolution (“plus-or-minus one count error”) can become a limiting factor when measurements are made very near the bottom of the instrument’s dynamic range. This fundamental resolution limitation due to the digitization process can exceed the TOLERANCE value when very low values of a parameter are being measured. To keep this factor from preventing settling, “floor” values are specified by the RESOLUTION values for each major measurement parameter. If the RESOLUTION value is larger than the TOLERANCE percentage multiplied by the actual measurement, the system uses the RESOLUTION value instead of the TOLERANCE value, multiplies it by an amount determined from the EXPONENTIAL or FLAT algorithm, and makes its decision on that particular comparison.

12.2.1. Recommended Values

The EXPONENTIAL selection matches the settling curves of many real-world devices and is useful for most types of measurements. The default TOLERANCE values are also selected as best estimates of the settling and accuracy required in most typical audio measurements. The AMPL and LVL default tolerances of 1% (approximately 0.1 dB) may need to be considerably tightened, however, when measuring the flatness of System One itself or comparably flat external devices. Values of 0.1% (approximately 0.01 dB) or even tighter may be called for under such circumstances. On the other

hand, if a particular test is measuring noise or a noisy signal such as crosstalk, a tolerance of 5% (0.5 dB) to 10% (1.0 dB) may be appropriate.

12.3. Averaging for Noisy Signals

Rather than examining successive readings and discarding them until they agree within the specified tolerance, the settling algorithm can also average together a specified number of successive readings and plot the computed average. This mode is selected by the AVG selection as an alternate to EXPONENTIAL or FLAT. When AVG is selected and a sweep begun, the algorithm will first wait out the SETTLING DELAY value. It will then acquire and average together the number of consecutive readings from the hardware which is specified in the DATA SAMPLES field. This average value will be plotted, the SOURCE-1 parameter will step to its next value, and the delay and averaging process repeated.

When AVG is selected, the minimum value used for SETTLING DELAY should be 200 milliseconds. In usual SOURCE-1 sweeps of generator parameters or the analyzer bandpass filter, a transient is caused at each SOURCE-1 step. A SETTLING DELAY shorter than 200 ms will result in that transient data being included in the averaged data, producing an erroneous result. Shorter delays, such as 30 ms, are usable in the settled modes (EXPONENTIAL or FLAT) since the settling process itself discards older samples until a succession of samples fits within the specified tolerance.

The number of samples selectable for AVG mode can be from 1 to 99. Note that the maximum entry in this same field for EXPONENTIAL or FLAT modes is 6. Thus, you will receive an error message when changing from AVG to either of the settled modes if the number in the DATA SAMPLES field is greater than 6. The solution is to first reduce the DATA SAMPLES value, then change from AVG to a settled mode.

12.4. Timeout

Under some circumstances, the stream of measurement samples may never settle within the conditions specified by the TOLERANCE value and the window shape. This can occur because the tolerances are set too tightly for the amount of noise on the signal being measured. It can also occur during distortion measurements at, for example, approximately half the power mains frequency; the second harmonic and power mains hum can beat together, producing a cyclic variation over a period of hundreds of milliseconds or seconds.

To prevent the system hanging up under such circumstances, the TIMEOUT function is part of the SWEEP SETTLING process. If settling is not achieved within the time specified in TIMEOUT, the system computes the average of the last six points in order to save and plot, then permits the generator to move on to the next step. A "T" is displayed at the lower margin of the graph below any points where timeout occurs. In DISPLAY TABLE

mode, the word "TIMEOUT" is displayed to the right of the data whenever timeout occurs. TIMEOUT is not used in external sweeps.

12.5. Settling Delay

The SETTLING DELAY parameter controls the interval between when the generator or any other internally swept parameter is commanded to step and when the system starts applying the settling tests to the measured data stream. During GENERATOR sweeps, it should never be set to less than 10-15 milliseconds, to allow for worst case relay bounce time and stabilization of the generator. 30 milliseconds is a good default value. In cases where there is an additional time delay through the device under test, the SETTLING DELAY should be set to a value slightly longer than the known value of the time delay. Examples of time delay in audio testing include tests of three-head tape recorders in simultaneous re-

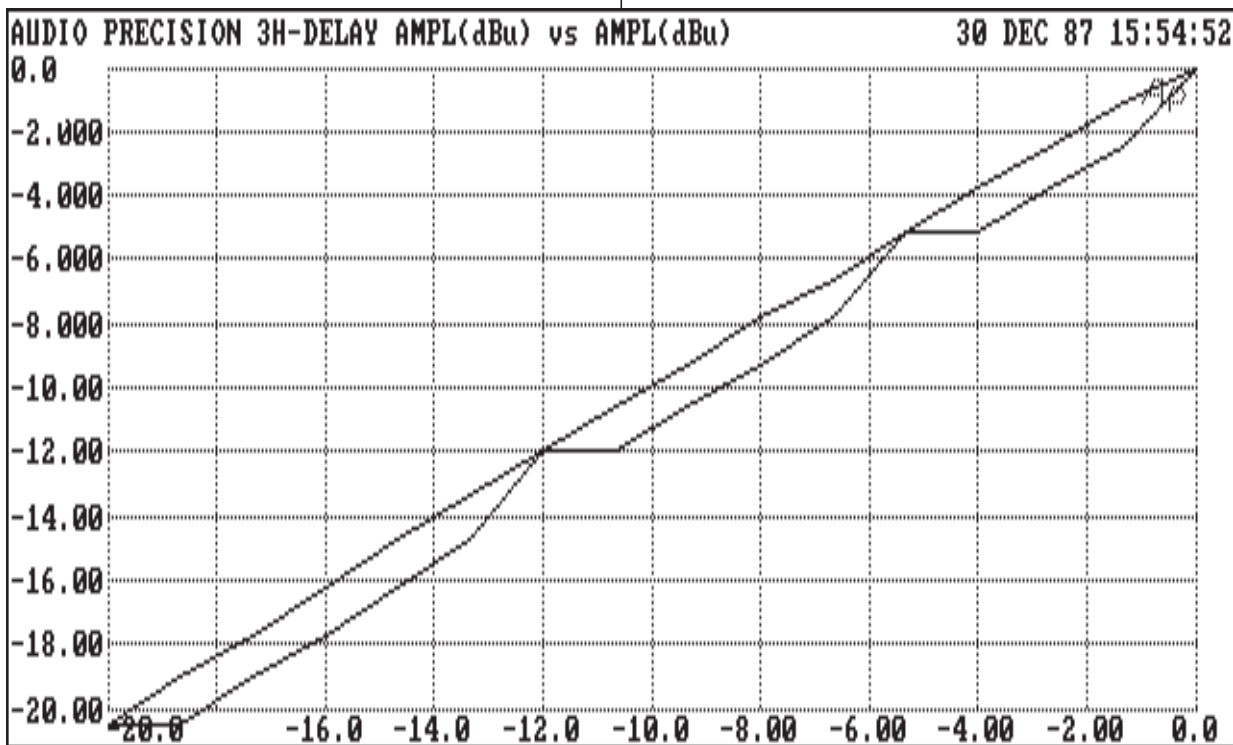

Figure 12-3 Determining Minimum SETTLING DELAY for Testing a Three Head Tape Recorder by use of 3H-DELAY.TST from Tests and Utilities Diskette

cord and playback mode, tests of analog or digital time delay units, and tests of satellite up and down links.

12.5.1. Testing for Delay Through the Device

A practical method to experimentally determine the minimum required SETTLING DELAY through a three-head tape recorder or similar device is via an amplitude vs amplitude (linearity) sweep. Set SOURCE-1 for a GEN AMPL sweep through a known-linear portion of the device's dynamic range, in relatively large steps such as 2 dB minimum. On a typical tape recorder, a GEN AMPL sweep from 20 to 0 dBu with 10 STEPS (2 dB per step), assuming a frequency of 1 kHz or less, is a good choice. Set SETTLING DELAY to a value which you are certain is longer than the delay time through the device. Select LEVEL as DATA-1, with GRAPH TOP and BOTTOM values corresponding to the expected output from the device. Such a test is stored on the Tests and Utilities diskette as 3H-DELAY.TST. If the device is unity gain, as is typical with professional tape recorders, these values would be 0 dBu and 20 dBu for the example given. Press <F9> for a sweep, which should result in a straight diagonal line plotted from the lower left to upper right corner of the graph. Use <Alt><F8> to "freeze" this graph in place.

You are now ready to experimentally determine the minimum required SETTLING DELAY. Change SETTLING DELAY to some lower value. For an extreme case of error, select a value as small as 30 milliseconds and press <F8>, then <F9>. You are likely to see an entirely new line or many new points plotted to the right of the reference line as the software settles on the amplitude output from the delaying device which was caused by the previous generator output step, but erroneously plots it offset to the right, at the horizontal value corresponding to the current generator amplitude (see Figure 12-3). Increase SETTLING DELAY and use <F8> and <F9> to bring back the stored reference and plot a new sweep. As you get close to the required SETTLING DELAY, many of the points will plot on the reference line but an occasional point will still plot

Gen. Freq.	Reading Rate
10-18 Hz	4/sec
18-29 Hz	8/sec
29-65 Hz	16/sec
>65 Hz	32/sec

Figure 12-4 Frequency vs Reading Rate in AMPLITUDE, BANDREJECT, THD+N, 2-CHANNEL Modes

BP Freq	Reading Rate
10-47 Hz	4/sec
47-75 Hz	8/sec
75-170 Hz	16/sec
>170 Hz	32/sec

Figure 12-5 Frequency vs Reading Rate in BANDPASS, CROSSTALK Modes

to the right of the line when the software mistakes old data as corresponding to the new generator amplitude. When you find a SETTLING DELAY which produces no error points to the right of the reference diagonal line, you may use this value on future tests of the device under the same conditions.

Note that delay is a function of tape speed on 3-head tape recorders. The SETTLING DELAY acceptable at 15 inches per second, for example, must be doubled for 7.5 inches per second.

SETTLING DELAY is also useful when recording a test tone tape to be used later as a playback test tape. In this application, SETTLING DELAY can be set up to several seconds to guarantee a minimum dwell time at each frequency as the recording is made. This additional time is necessary for EXTERNAL source testing, compared to the faster settling times during generator-based sweeps, since during EXTERNAL source tests the analyzer frequency

counter must acquire a stable frequency reading before the amplitude, distortion, or phase can be measured.

12.6. Auto and Fixed Sampling Rates

The AUTO selection on the DETECTOR line of the ANALYZER panel turns on an algorithm which optimizes the accuracy vs speed tradeoffs during most System One operation. It should thus be left in the AUTO mode for most applications. This algorithm takes charge of selecting reading rate and detector time constant (the RMS and AVG detectors each have several selectable time constants) as a function of frequency and test mode. It also switches the 22 Hz high pass filter into the circuit at frequencies above approximately 60 Hz. This algorithm, and the hardware it controls, is a major factor in the testing speeds System One is able to achieve while still maintaining data integrity.

When AUTO is selected instead of a fixed reading rate, System One will select the reading rate according to a number of modes, functions, and conditions as follows:

- In PANEL mode, selects 4 readings/second
- In bargraph mode (F2), selects 8 readings/second unless PSEUDO or RANDOM noise signals are selected on the GENERATOR panel. In this case, it selects 4 readings/second
- During EXTERNAL time “sweeps”, selects 32 readings/second except with a NOISE source selected on the generator panel. For EXTERNAL FREQUENCY and EXTERNAL LEVEL sweeps, selects 8 readings/second except with a NOISE source selected on the panel. If a PSEUDO or RANDOM noise source is selected on the generator panel, 4 readings per second is selected by AUTO.
- For all other SOURCE-1 selections (GEN, ANLR, SWI, DCX), chooses reading rate as follows:

PSEUDO or RANDOM noise signal	4/sec
SMPTE analysis	

mode	8/sec
CCIF analysis mode	8/sec
DIM analysis mode	16/sec
W+F mode	16/sec
All other modes	see Figure 12-4 and Figure 12-5

The remaining fields on the SWEEP SETTLING panel are involved only when using EXTERNAL sweeps. These lines are EXT SOURCE SAMPLES, and the MIN LVL value in Volts.

12.7. External Sweeps and Sweep Settling

During EXTERNAL sweeps the analyzer frequency counter measures the incoming frequency, the LEVEL voltmeter measures the incoming amplitude for comparison to the MIN LVL value, the DATA-1 and/or DATA-2 measurements are made, and System One waits until all are stable within the definition of the sweep settling panel. The DATA-1 and DATA-2 parameters are then accepted and plotted. If a frequency sweep is selected, the frequency counter continues to monitor the incoming signal but will not accept data and plot again until the measured frequency changes by more than a specified percentage from the previous value. For amplitude sweeps, the LEVEL voltmeter is monitored until the measured amplitude changes by more than the specified value. The SPACING parameter (which appears on the SWEEP (F9) DEFINITIONS panel only in EXTERNAL FREQ or LEVEL sweep modes) determines the percentage by which the frequency or amplitude must change before another set of measurements is taken. The cycle is repeated until halted by the operator (or by a reversal in frequency sweep direction to the frequency value set on the GENERATOR panel, if the EXTERNAL sweep was initiated with the <Shift><F9> operation).

EXT SOURCE SAMPLES is the number of consecutive frequency measurements (during frequency sweeps) or amplitude measurements (during amplitude sweeps) which will be compared to test for settling. These samples must agree within the TOLERANCE and RESOLUTION values specified for

FREQ or LVL at the top of the SWEEP SETTLING panel as described earlier for other data. MIN LVL prevents System One from taking data in EXTERNAL source mode when test signal dropouts occur, or in compact disc testing during the intervals while the disc player seeks from one track to the next. If the incoming signal amplitude (as qualified by the settling parameters) drops below the MIN LVL value, the system suspends data capture until the signal again exceeds that level. TIMEOUT is ignored during external sweeps.

When collecting amplitude, phase, or frequency data from a continuously-varying (analog) external source sweep, SOURCE SAMPLES must be set to 1. System One will then capture a set of data measurements each time the incoming frequency changes by more than the SPACING percentage from the previous measurement, without requiring the frequency to settle. If the analog sweep is fairly rapid, it may also be necessary to open up the TOLERANCE values for the measured parameters in order to obtain data. As in all EXTERNAL sweeps, be sure to select the fastest detector reading rate compatible with the lowest frequency at which accurate data must be obtained.

13. MENUS

```

CMD: RUN PANEL LOAD SAVE APPEND EDIT HELP XDOS DOS NAMES IF UTIL QUIT COMPUTE :
Run procedure, test, or graphs
AUDIO PRECISION SYSTEM ONE, v 2.10
  
```

Figure 13-1 Command Menu

The stimulus and measurement hardware of System One is principally controlled by Panels: the GENERATOR, ANALYZER, and SWEEP (F9) DEFINITIONS panels discussed in the preceding three chapters, plus several other more specialized panels described later in this manual. The selections and entries on these panels determine stimulus levels, frequencies, measurement functions, bandwidths, detectors, display formats and units, etc.

The Menus described in this chapter principally control more computer-oriented activities: loading files from disk and saving them to disk, linking several files together into procedures, editing files, attaching limit, equalization, or sweep files to a test file, taking conditional actions during procedures, sending control data to external devices, performing computations on test data, etc.

System One in general uses two levels of menus; in only one case do the menus extend to a third level. The top level (COMMAND, abbreviated CMD) menu is the line seen at original start-up of the system software, reproduced above. The table below shows the complete menu structure.

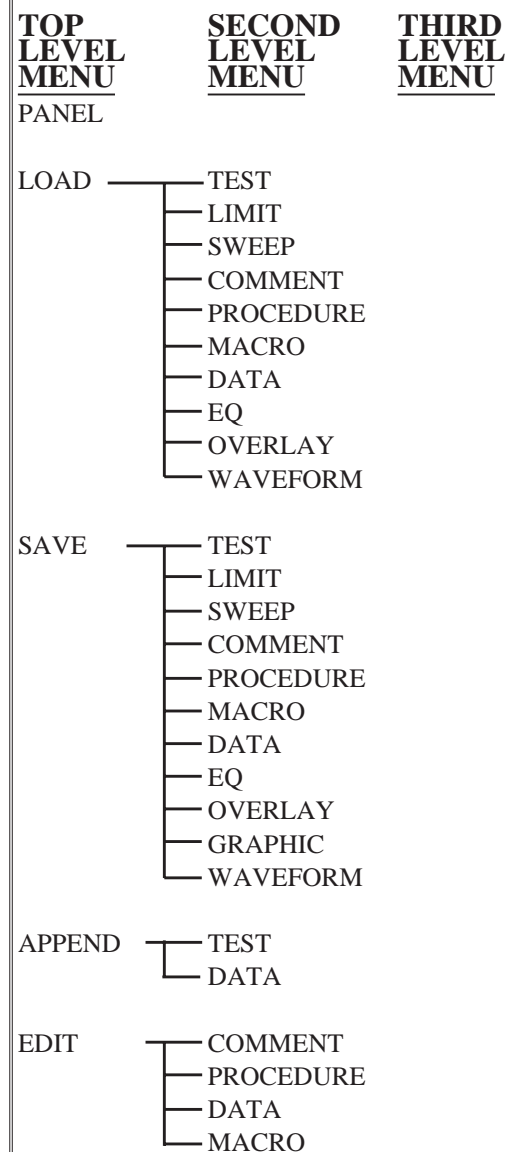
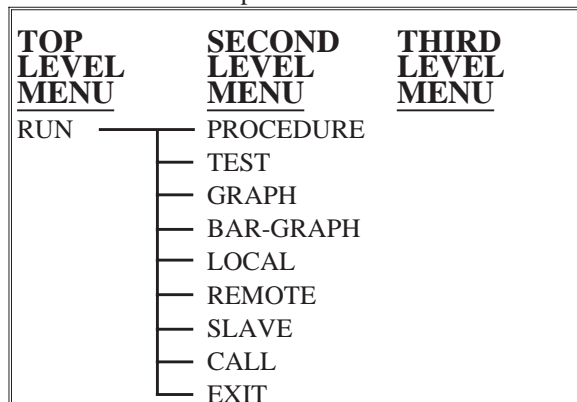

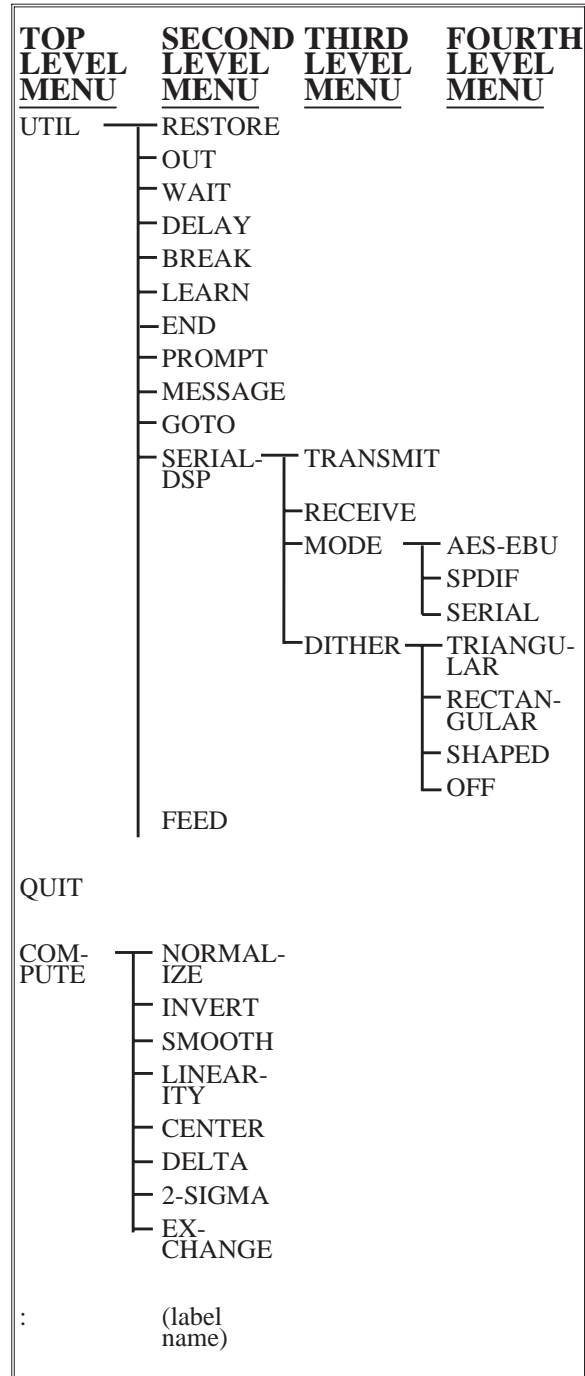
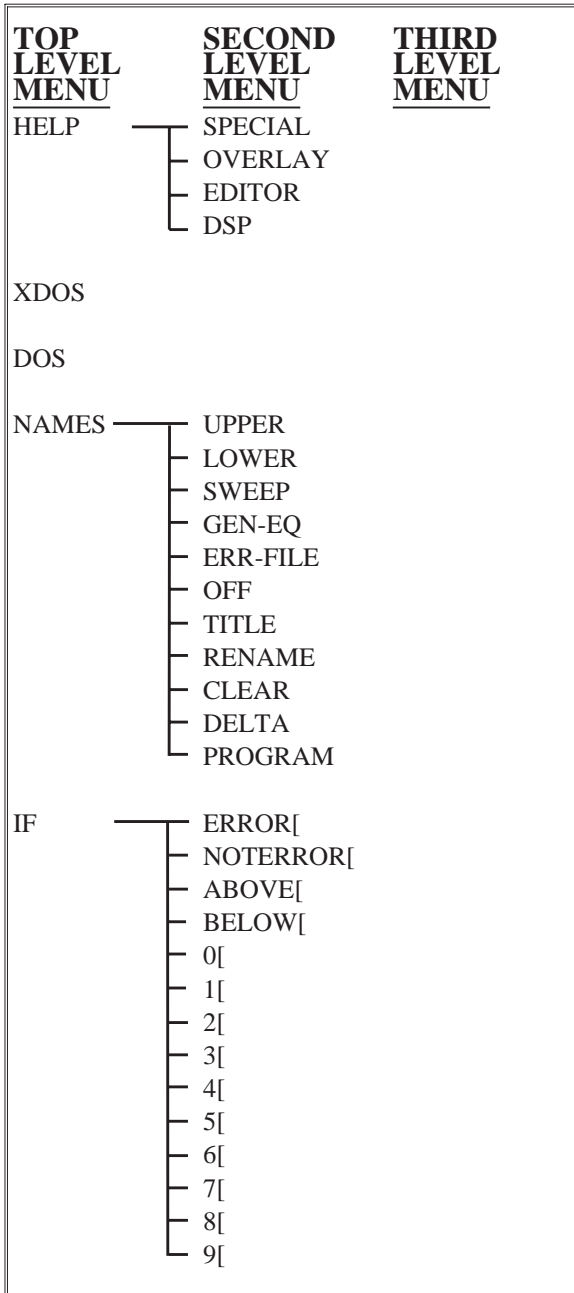

The single line description at the lower left of the screen (“Run procedure, test, or graphs”, in the example shown) provides more information than the menu command itself can carry. Selection of menu items is made in one of two fashions—by <Space> bar and <Enter> key (or mouse, if a mouse is available), or by pressing the key corresponding to the first character of the menu command.

With the <Space> and <Enter> technique, the <Space> bar moves the cursor clockwise through the selections. The <+> and key may alternately be used to move the cursor to the right or to the left, respectively. Rolling a mouse horizontally also controls the cursor. When the cursor is on the desired item, pressing <Enter> (right-hand mouse button) makes the selection.

Direct selection, regardless of the present position of the cursor, can be made by pressing the key which matches the first character of the desired command. The <L> key thus has the same result as using the cursor and <Enter> key to select LOAD.

13.1. Panel, Xdos, Dos, Quit

Four of the menu selections are single level and complete their entire operation when selected. These selections are PANEL, XDOS, DOS, and QUIT.

PANEL; display the instrument front panels.

XDOS; temporarily exit from System One software to the computer’s disk operating system. This will allow running a DOS program without removing System One from memory. You then resume System One operation instantly by typing EXIT <Enter>. Since System One software remains in memory, you will be limited on the size of other programs which can be run while in the XDOS mode. When System One loads, it attempts to leave 64k of memory available for operations under XDOS. See the “Controlling Memory Usage” section of the CREATING YOUR CUSTOM SOFTWARE START-UP PROCESS chapter for instructions on how to cause the system to leave more or less memory for DOS operations.

DOS; similar to XDOS, except returns to System One’s top level menu immediately after executing a single DOS command, rather than waiting for the EXIT <Enter> command. This command is useful for executing DOS commands during a procedure; see the PROCEDURES chapter.

QUIT; exit from System One software to DOS and allow System One software to be over-written in memory; thus, no ability to return to System One except by re-starting the software from the beginning by typing S1 <Enter>. Any stored image from the Image Save (<Alt><F8>) facility is lost when QUIT is executed. When the QUIT command is issued, System One automatically saves the current test in a file called APLAST\$.TST, the current procedure in a file called APLAST\$.PRO, and the current macro in a file called APLAST\$.MAC. If, when you next start System One, you wish to start up with this same test, procedure, and macro loaded which were in use when you quit, type S1 /L (for last) and the system will start with those files in use. See Command Line options in the CREATING YOUR CUSTOM SOFTWARE START-UP PROCESS chapter beginning on page 28-1 for more details.

Each of the remaining menu selections leads to a second level menu; these are RUN, LOAD, SAVE, APPEND, EDIT, HELP, NAMES, IF, UTIL, COMPUTE, and :. As you become familiar with System One commands, you may type the first letters of the desired commands in rapid sequence and proceed through the desired actions without stopping to have each menu displayed. For example, to load another test, press <Esc> <L> <T> filename <Enter>. Each of the two-level menu commands is discussed below, along with the second level menu choices.

13.2. Run Menu

**RUN: PROCEDURE TEST GRAPH BAR-
GRAPH LOCAL REMOTE SLAVE CALL
EXIT**

RUN PROCEDURE starts execution of any procedure presently in the procedure buffer. If the error message PROCEDURE BUFFER IS EMPTY

OR INVALID is displayed, it is either because no procedure has been loaded, because a procedure has been incorrectly edited to produce an unacceptable header or empty first line, or because a procedure from an earlier S1 software version has been loaded. If the earlier version procedure is compatible with the current version, it can be made to run by changing the first line of the procedure from PROCEDUREv1.xx or PROCEDUREv2.00 to PROCEDUREv2.10. Earlier version procedures should be compatible unless they included arrow-key-strokes to move the cursor around the panel to change settings during a procedure.

RUN TEST starts the test presently set up on the panel; this is identical to the <F9> key.

RUN GRAPH re-graphs data presently in memory, identical to the <F7> key.

RUN BAR-GRAPH displays the bargraph for analog indication of measurement parameters and analog control of stimulus. See the BARGRAPH chapter. This command is identical to the <F2> key.

RUN LOCAL, RUN REMOTE, and RUN SLAVE are all related to either “Split Site” (REMOTE) operation or use with the “S” (RS-232 serial) versions of System One. See the “Remote Mode for Transmission Testing and Laptop Computer Operation” chapter for details on these commands.

RUN CALL, followed by a sub-procedure name and <Enter>, jumps control from a procedure to the sub-procedure. See the Sub-Procedures section of the PROCEDURES chapter for more information and examples.

RUN EXIT, in a sub-procedure, returns procedure flow control to the point immediately following the RUN CALL statement in the calling procedure or sub-procedure. If a sub-procedure contain-

LOAD AND SAVE INFORMATION

```

Last loaded or saved Procedure (.PRO) file =
Last loaded or saved Comment (.TXT) file =
Last loaded or saved Data (.DAT) file     =
Last loaded or saved Macro (.MAC) file    =

File currently in memory                   =
(Last loaded or saved .TST, .LIM, .SWP, .EQ, or .OVL file)

```

```

LOAD: TEST LIMIT SWEEP COMMENT PROCEDURE MACRO DATA EQ OVERLAY WAVEFORM
Load test from .TST file                      AUDIO PRECISION SYSTEM ONE, v 2.10

```

Figure 13-2 Load and Save Information Panel

ing a RUN EXIT command is run by itself, an error message will result when the RUN EXIT line is reached since the sub-procedure was not called and does not know where to return.

13.3. Load Menu

LOAD: TEST LIMIT SWEEP COMMENT PROCEDURE MACRO DATA EQ OVER- LAY WAVEFORM

When the LOAD selection is made, an information screen is displayed in addition to the second-level menu choices. This screen shows the procedure, comment, data, and macro file last loaded or saved. It also shows the name of the file (.TST .LIM, .SWP, .EQ, or .OVL) currently in main file memory. This is the file whose panels will be displayed in PANEL mode, whose data will be displayed when the <F7> key is pressed, and whose data can be edited in Edit Data mode. See Figure 13-2 for an illustration of this information screen.

All Load commands have certain features in common. Each will ask for the file name of a previously-saved file of the appropriate type (xx.TST, xx.LIM, xx.SWP, xx.TXT, xx.PRO, xx.MAC, xx.DAT, xx.EQ, xx.OVL, xx.WAV) to load from disk. The first 88 file names (in the current directory) of that type will be shown and may be selected via arrow keys or mouse, or a file name of a compatible type (including disk drive prefix and/or complete subdirectory pathname, if not in the current directory) may be typed in. When typing in file names, the horizontal arrow keys maybe used to move back into the typed-in material to make corrections. The <Ins> key may be used to toggle back and forth between overtype mode and insert mode. *The DOS "wild card" symbols of * and ?, other disk drive designators such as B: or D:, and sub-directory pathnames may be used to view a directory of other types of files or files in other directories than the current directory.* See your DOS manual for more information on use of wild card symbols and path names.

Note that .TST, .LIM, .SWP, .EQ, and .OVL files all have the same structure and occupy the same main file memory area when loaded. Thus, if you wish to load and examine a test, then load and examine a limit file, and then go back to the test, you must load the test again since it will have been erased from memory (ram) when the limit file was loaded.

LOAD TEST asks for the file name of a previously-saved test to load into main file memory in order to either use the test setup or to examine the saved data (or both).

LOAD LIMIT asks for the file name of a previously-saved limit file to load into main file memory in order to examine and possibly edit the data.

LOAD SWEEP asks for the file name of a previously-saved sweep table file to load into main file memory in order to examine and possibly edit the specified frequency or amplitude steps.

LOAD COMMENT asks for the file name of a comment file to bring into the "Comments Buffer" section of memory, typically either to attach to the current test for print-out or for further editing of the comments. All comments and error files (files with xx.TXT file type) on the disk will be shown in alphabetical order; you may select the file via cursor or by typing in its name. Any other ASCII file may be loaded into the comments buffer if its full file name, including the extension, is typed in. Load Comment capability may thus be used to display a summary error file at the end of a test or procedure; the procedure SYS22CK.PRO distributed with System One software includes an example of this technique. *Load Comment may also be used to view ASCII files such as AUTOEXEC.BAT, CONFIG.SYS, and other files. These files may be edited in the comments editor and the edited versions may be saved under the original or new file names.*

LOAD PROCEDURE asks for the file name of a procedure file to bring into the "Procedure Buffer" section of memory, either to run or for further editing. All procedures files (files with xx.PRO file type) on the disk will be shown and may be selected with cursor or by typing.

LOAD MACRO asks for the file name of a previously-saved macro file to load into the “Macro Buffer” section of memory. Once loaded, it will define the keystroke sequences to be executed when a contact closure occurs at any of the eight pins of the PROGRAM CONTROL INPUT connector on the DCX-127 front panel. See the Edit Macro section below and the DCX-127 chapter for more details.

LOAD DATA asks for the file name of a previously-saved ASCII data file to convert into binary and bring into the test data section of main file memory, either to graph onto the screen (Run Graph or <F7>) or for editing. All data files (files with xx.DAT file type) on the disk will be shown and may be selected.

LOAD EQ asks for the file name of a previously-saved equalization file to bring into main file memory, typically for editing or to graph or examine.

LOAD OVERLAY asks for the file name of a previously-saved overlay file to bring into main file memory. The overlay file will set new test conditions for all fields which were saved, but will protect or preserve the values and parameters remaining from the previously-used test in any fields which were “punched out” when the overlay file was created and saved.

LOAD WAVEFORM asks for the file name of a previously-saved waveform acquired by the DSP modules in a System One + DSP or System One Dual Domain. That waveform will then be downloaded to the DSP module. Certain key settings of System One panels will also be restored to the settings in effect when the waveform was saved. See the DSP manual for more details.

13.4. Save Menu

SAVE: TEST LIMIT SWEEP COMMENT PROCEDURE MACRO DATA EQ OVER- LAY GRAPHIC WAVEFORM

When the SAVE selection is made from the COMMAND menu, an information screen is displayed in addition to the second-level choices. This

screen is identical to that displayed when LOAD is selected, and is illustrated in Figure 13-2 on page 13-4.

All Save commands have certain features in common. Each will ask for a file name under which to save the test, limit, sweep table, comments, procedure, macro, data, equalization, graphic data list, overlay, or waveform file. The file name supplied may be up to eight characters long and may include *alphabetic characters A through Z, numerals 0 through 9, and the symbols \$ () & ' _ - @ # { } % ~ !* DOS does not distinguish between upper and lower case letters in file names. The horizontal arrow keys may be used to move back into the typed-in material to edit it. The <Ins> key will toggle between overtype mode and insert mode when editing typed-in material. If you wish to save the file in a directory other than the current directory, you must supply the complete path name including disk drive prefix (if not the current disk) and subdirectory path. The full path name cannot exceed 26 characters. The extension (file type) need not be typed in and does not count as part of the 26-character limitation. The extension will be automatically supplied by the system, (unless a specific extension is typed in by the user) depending on the file type being saved: xx.TST for tests, xx.LIM for limits, xx.SWP for sweep tables, xx.TXT for comments, xx.PRO for procedures, xx.MAC for macros, xx.DAT for data, xx.EQ for equalization, xx.OVL for overlays, and xx.WAV for waveforms.

The first 88 files (in the current directory) of the type being saved will be shown alphabetically arranged on screen. Typing in the name of a file of the same type presently existing in the directory (or positioning the cursor on one of the file names displayed on screen and pressing <Enter>), will result in a message that the file name already exists. The system will request confirmation by pressing Y that you wish to over-write the existing file. If you do, the existing file will be destroyed and replaced by the current file you are saving. If you do not wish to destroy the existing file, press <Esc> Save (file-type) and supply a new file name which does not conflict. In a procedure (see the Procedures chapter), the Y for overwrite is not required. The soft-

ware assumes that the procedure has been properly planned and that it is permissible to over-write any file if the procedure issues a SAVE command.

SAVE TEST saves the current test setup, data, and comments (if any) to disk, with a xx.TST file type (extension). xx.TST files are binary files and cannot be viewed or edited by normal text editors. xx.TST files (and the identical-format xx.LIM, xx.SWP, xx.EQ, and xx.OVL file types—see below) occupy disk space which depends on the number of data points in the stored data. The minimum file size, with zero data points, is approximately 1,660 bytes for the header and panel setup information. Thirteen bytes are added for each data point. Thus, tests with up to 29 data points (28-step sweeps) will store in a 2k disk cluster. Tests with up to 186 data points (185-step sweeps) will store in a 4k disk cluster.

SAVE LIMIT saves the current test setup, data, and comments to disk, with a xx.LIM file type. *xx.LIM file types are binary files of identical format to xx.TST files and can be used interchangeably.* When attached to a test by the Names Upper or Names Lower command, only the data will be used. *The purpose of Save Limit is to create a distinctive file type (extension) so that only limit files will be displayed as the directory during Names Upper and Names Lower activities.*

SAVE SWEEP saves the current test setup, data, and comments (if any) to disk with a xx.SWP file type (extension). *xx.SWP files are binary files of identical format to xx.TST files and can be used interchangeably.* When attached to a test by the Names Sweep command, only the independent variable data (first column when viewed in DISPLAY TABLE or Edit Data modes) will be used. *The purpose of the Save Sweep command is to create a distinctive file extension so that only sweep table files will be displayed as the directory during Names Sweep activities.*

SAVE COMMENT saves, as an ASCII file, any text presently in the comments buffer. See Edit Comments for instructions on how to create text in the comments buffer. Comments files are saved with a xx.TXT file type. Save Comment is used

when creating a comments “form” for repeated use in different tests. *If the comments created are unique to the particular test and will not be used elsewhere, Save Comment is unnecessary since the comments buffer is automatically saved as part of the xx.TST file when Save Test is done.* Edit, Save, and Load Comments may also be used as a general-purpose text editor. If a specific extension is typed in, it will override the xx.TXT extension.

SAVE PROCEDURE saves, as an ASCII file, any procedure presently in the procedure buffer. See Edit Procedure below and the PROCEDURES chapter of this manual for instructions on how to create procedures. The xx.PRO file type will be added automatically.

SAVE MACRO saves the current contents of the Macro editor. Macros define the keystroke sequences which will be executed when an external contact closure is made at the PROGRAM CONTROL INPUT connector on the front panel of the DCX-127 module. This facility permits easy addition of completely flexible custom keyboards in addition to or in place of the standard PC keyboard. This is particularly useful in production test applications. The xx.MAC file type will be added automatically. See the Edit Macro section below and the DCX-127 chapter for more details.

SAVE DATA asks for a file name under which to save the data currently in memory as a tabular, comma-delimited ASCII file. This differs from the Save Test command, which saves test setup, data, and comments in a binary format not suitable for editing. *The purpose of Save Data is for transfer of data to other programs such as statistical, database, or spreadsheet programs.* The file type xx.DAT will be added automatically unless another extension is typed in.

SAVE EQ asks for a file name under which to save the equalization data currently in memory. *xx.EQ file types are binary files of identical format to xx.TST files and can be used interchangeably.* When used as an equalization file, only the independent and first dependent variable data (SOURCE-

1 frequency and DATA-1 amplitude) are used. See the EQUALIZATION chapter for more information on equalization capability.

SAVE OVERLAY asks for a file name under which to save the overlay file currently in memory. An overlay (xx.OVL) file differs from a xx.TST file only in that one or more panel fields have been “punched out”. The result, when an overlay file is loaded, is that the value from the previous panel conditions will be unchanged where any “punched-out” fields load. This has the effect of preserving a field from the previous test, instead of over-writing the parameter with a new value. Panels with one or more punched-out fields may only be saved as xx.OVL files. See the Partial Load (Overlay) section of the PROCEDURES chapter for more information.

SAVE GRAPHIC saves, under the file name supplied by the user, the necessary information to create a high-resolution (vector graphics) plot to an HPGL plotter or laser print to an HP LaserJet or PostScript-compatible laser printer such as the Apple LaserWriter. The saved file will have the extension .GDL (Graphics Data List. See the sections beginning on page 15-6 of the HARD COPY PRINT-OUT chapter for full details.

SAVE WAVEFORM saves, under the file name supplied by the user, the waveform data presently stored in data memory in the DSP module of a System One + DSP or System One Dual Domain unit. The .WAV extension will be automatically added. This waveform data may then later be downloaded from disk to the DSP unit by the LOAD WAVEFORM command for further analysis or display. The size of a saved waveform file on disk may be quite large (approaching 256 kbytes), depending on the amount of memory in the DSP unit, which FFT program was used to acquire the data, and whether the full contents of both data channels are saved. See the DSP chapter for more details.

13.5. Append Menu

APPEND: TEST DATA

The **APPEND TEST** and **APPEND DATA** commands permit loading and attaching data from a specified file to the end of the data presently in memory. Each command will ask for the name of a previously-saved file of the corresponding type (.TST or .DAT) to be appended to the data in memory. The data is appended following a $-1E+32$ value as a delimiter. This value is recognized as a special value during re-plots via F7. The system will then not draw a vector from the last point of the previous section of data to the first point of the next, eliminating re-trace effects. The entire data file, original plus appended, can then be saved or re-plotted with the F7 key exactly as a nested sweep re-plots.

The system will append the data from the specified file without checking for consistency in measurement parameters or units between the files. The user must thus assure himself or herself that it is logical to append files. When the file to be appended is logically consistent with the data in memory (for example, both frequency response tests) the units in which they are stored must still be considered. If both files have amplitude measured in absolute units (Volts, dBV, or dBu), the appended data will be correctly converted into the display units of the test presently in memory, to which they are appended.

If the appended test file used non-absolute units such as dBm or Watts (which depend on the circuit impedance value), dBr, or one of the relative frequency units, additional factors must be considered. In all cases, non-absolute units in the stored file being appended will be interpreted in terms of the reference value for that unit on the panel of the test into which it is loaded. dBm or Watts units will thus be correctly appended only if the dBm/W REF value on both tests is identical. If the appended test file used dBr units, the data will not load as the correct absolute amplitudes unless the dBr REF value saved with the test is identical to the dBr REF value on the LVF1 panel of the test to which it is being appended. When preserving absolute amplitude rela-

tionships is important, the best procedure when appending tests with dBr units is to first change to absolute units (dBU, dBV, or V) and re-save, then append. If the goal is to append dBr tests so that all pass through zero dBr at a specific horizontal value, a copy of each test can be prepared with the dBr REF value set to a standard value such as one Volt. Compute Normalize is then used to cause each test to go through zero dBr. The test copy can then be saved and ultimately appended.

13.6. Edit Menu

EDIT: COMMENT PROCEDURE DATA MACRO

EDIT COMMENT takes you to a full-screen editor. See the General Edit Capability section at the end of this EDIT section for a discussion of the editor capability. In Edit Comments mode, you can create alphanumeric text which will be saved with the current test and printed out along with a graph via Run Graph or <F7> or Run Test or <F9>, followed by the <*> key (without pressing <Shift>). These comments could consist of operator name, test conditions such as temperature, humidity, or voltage, status of the device under test such as the value of experimental components or the position of controls, or other information. When a test is saved, any comments in the edit comment buffer will also be saved along with the setup and data in a xx.TST file. It is also possible to save the comments buffer separately via Save Comments; this will result in a xx.TXT file.

The double vertical bar symbols in the “ruler lines” at the top and bottom of the editor screen mark the edges of the graph printout to which the comments will be attached. If it is desired to have comments exactly aligned below the graph boundaries, comments text should be generated only between those two columns. Note that the spacing between these symbols changes with different video display systems and changes if the /P command line option is used to specify different widths for graphic printout.

EDIT PROCEDURE uses the editor in order to edit or create a test procedure—a series of steps linked together in the desired order, with interspersed prompting messages to an operator, control commands via an interface to external hardware, and inclusions of user-written sections of software in other languages such as BASIC. Edit Procedure mode thus permits generation of a complete set of tests on a device which can then be run by operators of even sub-technician skill level. See the PROCEDURES chapter for complete details.

EDIT DATA places you in the editor with tabular data from the most recent test taken by the xx.TST file or current panel setup. The principal purpose of the Edit Data capability is to modify or create files for use as limits, sweep tables, or equalization curves. Note that the Edit Data function must translate data from the binary format in which it is stored into a readable ASCII format in columns, which can take several seconds for a long data file. Similarly, when <Esc> is pressed to exit from Edit Data to the command menu, several seconds may be required to translate all the data back into binary format if any data has been changed; if the data was simply examined but not changed, the transition back to the menu will be very rapid.

EDIT MACRO command moves you into the macro editor, used for defining actions which will be triggered by contact closures at the PROGRAM CONTROL INPUT connector of the DCX-127 module. This capability is intended for limited-function keyboards which will replace or supplement the computer keyboard, particularly in production test applications with limited-experience operators.

The PROGRAM CONTROL INPUT connector supports up to eight individual switches, connected to pins 1 through 8. A contact closure to ground (pin 9) at any of those contacts will trigger the “playback” of the keystroke sequence defined as the corresponding macro (1 through 8) in the currently-loaded macro file. Macro files may be created, saved (xx.MAC file type), and loaded as desired to define and re-define the functions.

Each macro is defined by a line or lines beginning with

N=

or

N+

where N is the number from 1 through 8 corresponding to the connector pin which will control it. The = sign is used for normal priority macros, and the + sign for high priority macros. The numeral must be in the first column with no preceding spaces. There must not be a space between the numeral and the = or + sign. Spaces following the = or + sign will be interpreted exactly as they would be during a procedure. For example, if the macro includes PANEL mode with the cursor on a multiple-choice field, spaces will move the cursor through the choices to the right. Each macro definition continues until the beginning of the next definition or the end of the buffer. Thus, it is possible for a single definition to occupy several lines.

Macros may be created directly in the editor or may be "learned" into the Procedure editor via the Util Learn feature and then transferred into the Macro Editor. A number of keystrokes which could be useful in macros cannot be directly created in the editor and thus must be learned in Util Learn mode and transferred into the Macro Editor. Figure 13-3 shows the IBM graphic representation of a number of those keystrokes, as they will be seen after pressing the corresponding keys during a Util Learn operation.

An entire procedure can be learned via Util Learn, saved with the .PRO extension, and loaded into the macro buffer by typing in the full name including the .PRO extension. It may then have the "1=" or "1+" macro designator added and the PROCEDUREv2.10 and UTIL END header and footer removed and be re-saved under another name with the .MAC extension.

Screen Display	Learn Mode Keystroke	ASCII Editor Keystrokes	Function
↑	<up arrow>	<Alt>24	cursor up
↓	<down arrow>	<Alt>25	cursor down
←	<left arrow>	<Alt>17	cursor left
→	<right arrow>	<Alt>16	cursor right
␣	<Ctrl><Home>	<Alt>235	panel cursor to ref. position
␣	<Home>	<Alt>187	panel cursor to top
␣	<End>	<Alt>195	panel cursor to bottom
␣	<PgDn>	<Alt>197	next set of panels
␣	<PgUp>	<Alt>189	last set of panels
␣	<Ins>	<Alt>198	insert mode (toggle to overwrite)
␣		<Alt>199	decrement value
+	<+>	<Alt>43	increment value
*	<*>	<Alt>42	screen dump print-out
␣	<Ctrl><right arrow>	<Alt>232	right end of mult. choices
␣	<Ctrl><left arrow>	<Alt>231	left end of mult. choices
␣	<Ctrl><PgDn>	<Alt>234	bottom of editor
␣	<Ctrl><PgUp>	<Alt>248	top of editor
␣	<Alt><P>	<Alt>141	punch out present field
␣	<Alt>	<Alt>164	blank all panel fields
␣	<Alt><R>	<Alt>128	restore all panel fields
␣	<Alt><A>	<Alt>146	increment overlay video attribute
␣	<Alt><S>	<Alt>147	decrement overlay video attribute
␣	<Alt><Z>	<Alt>160	set overlay video attribute to zero

Figure 13-3 Screen Appearance of Keystrokes Which May Be Used in Procedures and Macros

In the typical situation where several macros are to be defined, however, it is simpler to transfer them from the procedure editor to the macro editor via the <Alt><F6> capability. Any block of material in the Edit Procedure (or Edit Comment or Edit Data) buffer which is marked with the <Alt><F6> key will be deleted into the copy buffer of the Edit Macro buffer. This contrasts with the action of the <F6> key (without the <Alt> key), which deletes only into the copy buffer of the Editor section presently being used. After using <Alt><F6> to move text from the Edit Procedure buffer to the Edit Macro copy buffer, you can then exit to the menu with <Esc>, Edit Macro, move the cursor to the desired insertion point, and press <Alt><F5> to copy the text into the Edit Macro buffer. The additional information (3=, 5+, etc.) may then be added and the macro saved with the desired name.

Any macro terminates when it starts a procedure, even if there were additional keystrokes still in the macro. Any macro terminates if it causes Edit Macro. All macros are ignored when in Edit Macro mode.

Normal macros (=) will run if selected while a procedure is paused. The contact closure which would normally start a normal macro will be ignored if a procedure is running or if another macro is running.

High priority macros (+), if the initiating contact closure is made while a procedure is running, will immediately start executing. Since the status of the procedure at this time is undefined, the interaction of the macro and procedure running simultaneously is undefinable. It is thus best to start most high priority macros with:

N+/A1

This is the "procedure language" code for <Alt>F1, which aborts a procedure without turning off the generator. An exception to this rule would be a macro intended to be used as the "panic button" to stop any activity, which would be:

N+/F1

A macro to pause a procedure and commence again after pause would be:

N+/F10

A high priority macro will terminate any other macro running at the time the contact closure is made.

See the Program Control Input section of the DCX-127 chapter for more information and examples of macros.

13.6.1. General Edit Capability

A summary of all the keys usable in EDIT mode may be brought to the screen at any time by pressing <Esc> Help Editor; this screen is reproduced as Figure 13-7.

The editor functions in either insert mode or overwrite mode, selected by alternate operations (toggle) of the <Ins> key. When first selected, the editor will always be in insert mode. Movement of the cursor is controlled by the arrow keys, <Home>, and <End>. <PgUp> and <PgDn> permit paging through text. The <Ctrl> key "amplifies" the function of the left and right arrows and the <Home>, <End>, <PgUp>, and <PgDn> keys. Specifically, <Ctrl><PgDn> takes you to the end of the buffer and <Ctrl><PgUp> to the top of the buffer.

A section of text may be deleted to a copy buffer within that editor by moving the cursor to one end of the section, marking it by use of the <F6> key, then moving the cursor to the other end of the section and pressing <F6> again. If it is desired to copy the text from the buffer at some point, move the cursor to that point and press the <F5> function key. Only the block of text most recently moved to the buffer with the <F6> key will remain; any text previously in the buffer will be lost. Text in the "delete buffer" is maintained even through the loading of another file into that same editor, so the delete buffer may be used to "cut and paste" or copy text from one procedure file to another, one comments file to another, etc.

```

===== SYSTEM ONE STATUS AND INFORMATION =====
Maximum Data Points          = 410    (    0 used)
Internal EQ, Limit, Sweep Points = 200
Maximum Edit-Data Size      = 24657 (    0 used +    0 in copy buffer)
Maximum Edit-Procedure Size = 13523 (    0 used +    0 in copy buffer)
Maximum Edit-Comment Size   = 13523 (    0 used +    0 in copy buffer)
Maximum Edit-Macro Size     = 3002  (    0 used +    0 in copy buffer)
Bytes Reserved for DOS      = 65536
DSP Acquisition Buffer Size   = 0

PCI type          = 1 (at address 238 hex)
Display type     = 12 (UGA, Color Monitor)
Printer Status   = 90 hex, Selected, Not Busy, Paper OK
Graph Print      = Mode 3, Portrait, 3.3" High (72 dpi), 5.3" Wide (240 dpi)

Local Instruments:      GEN = Available
(updated by UTIL RESTORE) ANLR = Available
                        DCX = Not Connected
                        SWI = Not Connected
                        DSP = Available (+ DIO opt.)
                        CPU = 80386 with 80387 math coprocessor

=====
HELP: SPECIAL OVERLAY EDITOR DSP PANEL
Show special functions keys help screen      AUDIO PRECISION SYSTEM ONE, v 2.10

```

Figure 13-4 HELP Information Screen

```

===== SPECIAL FUNCTIONS KEYS =====
F1          Turn generator off NOW! Also aborts procedure playback.
Alt-F1     Aborts procedure playback without changing generator.
F2         Display readings on BAR-GRAPH screen.
F3         Set GEN dBr reference to the present GEN amplitude setting.
Alt-F3     Set GEN Freq reference to the present GEN frequency setting.
Ctrl-F3    Regulate as specified (and if enabled) on Regulation panel.
F4         Set Analyzer dBr reference to the present measurement.
Alt-F4     Set Analyzer Frequency reference to the present measurement.

F7         Plot data from memory. Use graph already on-screen if possible.
Alt-F7     Plot limits.
Alt-F8     Store graphics image of screen into memory.
F8         Recall previously saved graphics.
F9         Measure and plot new data. Use graph already on-screen if possible.
Ctrl-F9    Measure and plot new data, keeping old data.
Alt-F9     Auto-repeat test with erasure of last trace.
Shft-F9    External test with termination on reversal to panel frequency.

F10        Pause/continue (used during sweeps and procedures).
Alt-F10    Single step procedure (used after F10).
Ctrl-F10   Pause procedure for user numerical input.
*          Special Print-screen with comments.
Shft-PrtSc Normal ROM-BIOS Print-screen.

```

Figure 13-5 HELP SPECIAL Screen

OVERLAY KEYS FOR PANEL EDITOR			
Alt-P	Punch out the field on panel selected by cursor. Punched out fields will be missing in saved overlays.		
Enter	Returns the selected field to normal.		
Alt-B	Blanks all fields.		
Alt-R	Restores all fields.		
Alt-A	Adds 1 to video attribute value for overlay fields.		
Alt-S	Subtracts 1 from video attribute value for overlay fields.		
Alt-Z	Zeros the video attribute for overlay fields.		
S1 /On	Command line option to set the video attribute to 'n'.		
A Table of a few Video Attributes with effects on selected displays.			
Value	Color Display	Monochrome Display	Monochrome with intensity
0	Black	Black	Black
1	Dark Blue	Under-score	Dim
112	Reverse Video	Reverse Video	Reverse Video
135	Flashing White	Flashing	Flashing
Overlay video attribute presently = 1			

Figure 13-6 HELP OVERLAY Screen

EDITOR KEYS	
Up	Move cursor up one line.
Down	Move cursor down one line.
Left	Move cursor left one (1) character.
Right	Move cursor right one (1) character.
Ctrl-Left	Move cursor left five (5) characters.
Ctrl-Right	Move cursor right five (5) characters.
Home	Move cursor to the beginning of the line.
End	Move cursor to the end of the line.
Ctrl-Home	Move cursor to the top of the screen.
Ctrl-End	Move cursor to the bottom of the screen.
PgUp	Move one page towards the beginning of the text.
PgDn	Move one page towards the end of the text.
Ctrl-PgUp	Move to the beginning of the text.
Ctrl-PgDn	Move to the end of the text.
Del	Delete the character at the cursor.
Backspace	Delete the character before the cursor.
Insert	Toggle between Insert and Overtyping editing modes.
F5	Copy the Delete buffer to the text buffer at the cursor.
Alt-F5	Copy the Edit Macro Delete buffer to the text buffer.
F6	Block Delete to buffer from cursor to where F6 is again pressed.
Alt-F6	Block Delete to the Edit Macro Delete buffer.

Figure 13-7 HELP EDITOR Screen

If it is desired to move sections of text between editor sections (for example, from the procedure editor to the macro editor), the <Alt><F6> and <Alt><F5> keys may be used. Text marked at its beginning and end *in any editor* with the <Alt><F6> key will be deleted to the copy buffer of the Macro editor. Text currently in the Macro editor copy buffer will be copied to the present cursor position *of any editor* section when the <Alt><F5> key is pressed.

Note that the Load Comment, Edit Comment, and Save Comment capability may also be used as a simple, general purpose text editor to review or generate text files such as AUTOEXEC.BAT files. The automatic filename extension of xx.TXT given to comments files when saving can be over-ridden by supplying an explicit file type, such as xx.BAT if generating or editing a batch file.

13.7. Help Menu

HELP: SPECIAL OVERLAY EDITOR DSP PANEL

When the HELP selection is made, an information screen is displayed in addition to the second-level menu choices. This information screen shows memory assigned to the various buffers controlled by the /B option at S1.EXE startup. It also shows information on the interface card, display type, printer, print screen function, which instrument modules are connected to the system, and computer processor and math coprocessor type. This screen is reproduced in Figure 13-4.

HELP SPECIAL puts on screen a one-page summary of the effect of the function keys <F1> through <F10>. The Help Special screen is reproduced in Figure 13-5.

HELP OVERLAY puts on screen a one-page summary of the keys associated with overlay mode. The Help Overlay screen is reproduced in Figure 13-6.

HELP EDITOR puts on screen a one-page summary of the keys available when in any of the Edit modes. The Help Editor screen is reproduced as Figure 13-7.

HELP DSP displays a one-page summary of the key features of the particular DSP program which has been attached to a test and thus down-loaded to the DSP module. The Help DSP screen is thus completely DSP program-dependent.

HELP PANEL displays a summary of the two-character mnemonic codes which permit instant jumping to often-used fields on each software panel. These codes may be used during manual operation or to expedite making panel changes during a procedure.

13.8. Names Menu

NAMES: UPPER LOWER SWEEP GEN- EQ ERR-FILE OFF TITLE RENAME CLEAR DELTA PROGRAM

When NAMES is selected or the <N> key is pressed, the Names screen information display will appear in addition to the Names Menu subsidiary choices, as shown in Figure 13-8. This panel shows the names of the delta, upper and lower compare (limits), sweep source, generator equalization, error reporting, and DSP program files (if any) attached to the test presently in memory. The Names panel also shows the current graph title (normally AUDIO PRECISION). If you are upgrading procedures from version 1.60 to 2.10, note that three of these commands have been slightly changed since version 1.60. They must be changed in any 1.60 procedures imported for use under version 2.10 software. These three changed commands are NAMES GEN-EQ (formerly NAMES GEN#1-EQ), NAMES ERR-FILE (formerly NAMES ERROR-FILE), and NAMES RENAME (formerly NAMES RENAME-TEST).

NAMES UPPER asks for entry of the name of a file whose data is to be used as the upper acceptable limit to which currently-measured data will be compared during go/no-go testing. The file name may

be typed in, or selected from the directory with the cursor and <Enter> key. The displayed directory will show only files with the xx.LIM extension, but xx.TST, xx.EQ, or xx.SWP files could also be used by explicitly typing them in. The file named as the UPPER limit will normally have been created using the Edit Data capability. See the ACCEPTANCE TEST LIMITS chapter for a discussion of how to create a file for use as a limit.

NAMES LOWER is identical in principle to the Names Upper command, with the file name for the lower comparison test limit being attached to the test file.

NAMES SWEEP permits attaching to a test file another file to be used as a sweep source table. STEP TABLE ON must also be selected on the SWEEP TEST DEFINITION panel for the table to be used in the test. The directory will display only those files with a xx.SWP extension, but xx.TST, xx.EQ, and xx.LIM files have identical formats and

might be used in some circumstances. See the Table-Based Sweeps section of the SWEEP (F9) DEFINITION chapter.

NAMES GEN-EQ (formerly NAMES GEN#1-EQ) permits attaching to a test file another file to be used as an equalization file, controlling the output amplitude of the generator as a function of frequency. The directory will display only those files with a xx.EQ extension, but xx.TST, xx.SWP, and xx.LIM files have identical formats and might be used in some circumstances. See the EQUALIZATION chapter for more detail.

NAMES ERR-FILE (formerly NAMES ERROR-FILE) permits assignment of a file name into which out-of-limits information will be written during execution of a test with limits, so that a failure tag or report of deviations may be printed out or stored. When the test first runs, it will create an ASCII file of the assigned name with the xx.TXT extension. Each execution of a test will cause the test file name, date, time, and column headings for the inde-

NAMES	
Title of graph	= AUDIO PRECISION
Compute Delta file	= SUB-RESP.TST
Upper Compare file	= RESP-UP.LIM
Lower Compare file	= RESP-LO.LIM
Sweep Source file	= FCC.SWP
Gen Equalization file	= 75US_DE.EQ
Error Reporting file	= PROOF.TXT
Program file for DSP	= FFTGEN.DSP
Program version for DSP	= 2.10-00
Waveform file for DSP	= ISO31.WAV
File currently in memory	= MAINRESP.tst
(Last loaded or saved .TST, .LIM, .SWP, .EQ, or .OVL file)	
<hr/> NAMES: <u>UPPER</u> LOWER SWEEP GEN-EQ ERR-FILE OFF TITLE RENAME CLEAR DELTA PROGRAM Select file for upper compare limit AUDIO PRECISION SYSTEM ONE, v 2.10	

Figure 13-8 Names Panel

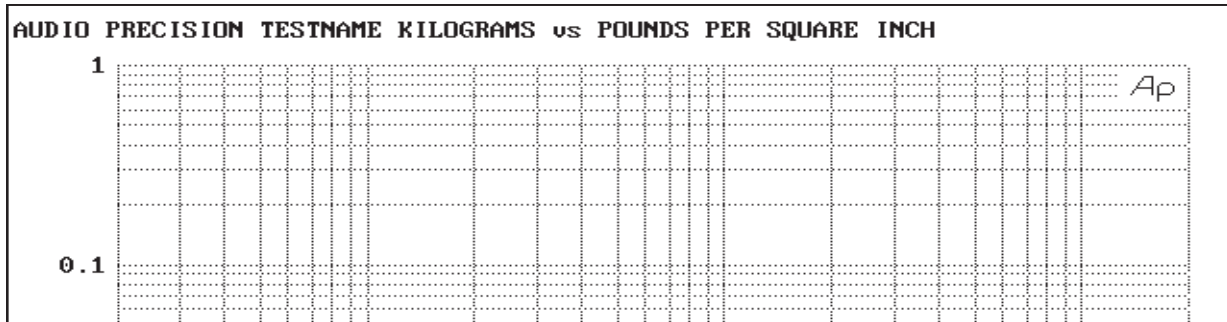

Figure 13-9 Top of Mono-Graph with Long Title Replacing Original Title, Test Name, and Units

pendent variable and dependent variable(s) to be written into the error file. If no out-of-limits measurements are made, the message “All data within limits” will be written into the file. The same error file may be named to more than one test file. Each time a test file runs, it will append error information to anything already in the error file; thus, naming one error file for all the tests in a procedure will cause it to become the master error summary of the entire set of tests. In such cases, the first line of the procedure should normally be

```
DOS ERASE xx.TXT
```

(where xx.TXT is the error file name) to erase the file remaining from when the procedure last ran.

If PRN or LPT1 (the DOS designations for the system printer) are specified instead of a file name, the system printer will print out the error file contents at the conclusion of the test.

NAMES OFF temporarily disconnects an error file from a test. The error file name can then be re-attached to the test by the sequence:

```
NAMES ERR-FILE <Enter>
```

The purpose of Names Off is for use in conjunction with Compute Center. Compute Center will slide test data vertically for best fit between upper and lower comparison limits. If Compute Center is to be used in a procedure with an error file, it is not normally desired for failure data to be written into the error file when the test is first run. Instead, the desired sequence is to run the test with limits attached but error file disconnected, run Compute Cen-

ter to center the data, re-connect the error file, and then re-compare the data to limits via F7, after the data has been slid for best fit.

NAMES TITLE permits replacement of the AUDIO PRECISION title in the upper left corner of graphs (CGA color displays do not show the AUDIO PRECISION name due to larger characters required by the poorer resolution). The Names Title function may be used, for example, by a manufacturer who desires to furnish test data to his customers and would prefer his company name in the title.

Names Title may also be used to deliberately over-write the standard units so that user-assigned units will appear in the top graph legend. Long titles will replace portions of the top line information. With MONO-GRAPH display or EGA and VGA COLOR-GRAPH displays, the maximum number of characters in the top row of the graph is 79. The top row may consist of four elements: the TITLE (normally AUDIO PRECISION), the test name (up to eight characters of the DOS file name, not including the .TST extension), the measured parameters and units (for example, THD+N (%)), and the date and time. If the total number of characters in those four elements exceeds 79, the lower priority elements will not be displayed. The priority among the elements is:

```
Title
Parameters and Units
Date and Time
Test Name
```

Thus, the test name is the first element to disappear when all elements (plus spaces between the elements) exceed 79 characters total. The date and

time are the second to disappear, etc. Since some parameters have more characters than others (BANDPASS vs THD+N, for example), the point at which lower-priority elements disappear will vary with test parameters.

Figure 13-9 is an example in which a long title has been substituted for the usual title. The long “title” includes a title, test name, and custom units:

```
AUDIO PRECISION TESTNAME KILO-
GRAMS vs POUNDS PER SQUARE INCH
```

This causes the actual units and test name to be replaced. Note that the horizontal arrow keys and <Home> and <End> keys may be used to move back into the “title” and the <Ins> key toggles between overtype mode and insert mode, to simplify editing of titles.

With CGA COLOR-GRAPH display, the title, test name, date, and time are not normally displayed due to the poorer resolution of the CGA display system. If, however, a title of more than 16 characters is entered in NAMES TITLE, the units will be deleted from the top line and the title displayed instead. The maximum title length which can be displayed in CGA COLOR-GRAPH mode is 39 characters.

NAMES RENAME (formerly NAMES RE-NAME-TEST) permits replacement of the test name which will be shown in the top line of monochrome-displayed or table-displayed and printed graphs. This command changes the name in computer memory; if the test had already been saved under its previous name, the old version of the xx.TST file will still remain on disk. A Save Test operation will save the test again under its new name.

NAMES CLEAR permits wiping out in one action up to seven files attached to a test: the upper comparison file, lower comparison file, error reporting file, sweep source file, generator equalization file, delta file, and DSP program file. *When a series of tests are being generated by modifications of an earlier test, any of these files attached to the original test will “propagate” through successive*

modifications unless conscious effort is made to remove them. The Names Clear function simplifies their removal.

NAMES DELTA specifies a file to be used in a Compute Delta operation. Compute Delta (see below) then subtracts the data in the named file from the data presently in memory. Note that, beginning with version 2.00, a Delta file name attached to a test is saved with the test just as any other attached name. In earlier software versions, a Delta file name did not save with the test but was effectively part of the environment, working with all tests loaded until it was replaced with another Delta file name.

13.9. If Menu

```
IF: ERROR[ NOTERROR[ ABOVE[ BE-
LOW[ 0[ 1[ 2[ 3[ 4[ 5[ 6[ 7[ 8[ 9[
```

The various **IF** commands permit conditional actions to take place in a procedure. IF ERROR[, IF NOTERROR[, IF ABOVE[, and IF BELOW[all cause the conditional action to take place depending upon whether an out-of-limits error occurs during the immediately preceding test.

The IF n[commands permit conditional action to take place depending upon which of the ten number keys, 0 through 9, the operator presses at a point in a procedure when the <Ctrl> F10 key (/C10) is executed.

The action to be taken in either case is described by the keystrokes between the If xx[statement and a closing bracket,]. As an example, assume that a file named ERRORFIL has been named as the error file for a test. If it is desired to have a procedure print an error file and halt the test when any out-of-limits measurement occurs, this could be the next line in the procedure after the <F9> command which starts the test:

```
IF ERROR[ DOS COPY ERRORFIL.TXT
PRN/R UTIL BREAK ]
```

If no out-of-limits measurement is found, the IF command will be skipped and the procedure will continue through the following steps. If an error does occur, the system will go to DOS, copy a file named ERRORFIL.TXT to the printer (note the /R for <Enter>, to select this file), then return to System One software and halt the procedure.

IF ERROR[permits conditional actions when an error occurs during a test with limits. The action to be taken is described by the keystrokes between the If Error[statement and a closing bracket,].

IF NOTERROR[permits conditional actions when an error does not occur during a test with limits. The action to be taken is described by the keystrokes between the square brackets [].

IF ABOVE[permits conditional actions to take place in a procedure if a measurement above an upper limit value occurs during a test. The action to be taken is described by the keystrokes between the If Above[statement and a closing bracket,].

IF BELOW[permits conditional actions to take place in a procedure if a measurement below a lower limit value occurs during a test. The action to be taken is described by the keystrokes between the If Below[statement and a closing bracket,].

IF n[permits conditional actions to take place in a procedure when the operator presses a number key (0 through 9) on his computer keyboard corresponding to statements in the procedure. This permits creation of menus within procedures so that operators may select from a number of possible courses of action. See the "Conditional Branching Upon Operator Input" section beginning on page 25-6 of the PROCEDURES chapter for more detail.

13.10. Util Menu

**UTIL: RESTORE OUT WAIT DELAY
BREAK LEARN END PROMPT MESSAGE
GOTO AES/EBU FEED**

UTIL RESTORE sets the System One hardware to the current condition of the System One software. It is not normally used unless there has been a power interruption, or if the System One hardware was not turned on and connected to the computer at the time the System One software was started.

UTIL OUT permits sending a data word to a specified address port within the computer or to digital output ports A, B, or C of the DCX-127 module. The purpose of this capability is control of external devices through an unused parallel port, via an interface card plugged into the computer, or via the DCX-127.

Util Out is normally used as part of a procedure, often to change the status of a remotely controllable device under test between portions of the test. Examples include switching a tape recorder from record to play mode or rewinding the tape, or switching the gain or equalization of a remotely controllable mixing console or audio processor. Util Out is the one menu command which does not return you to the top level menu after execution. This was done because sequences of several consecutive outputs are frequently required to control a device. For example, a device controlled by a momentary contact closure may require two commands via a relay card; one to close the relay, and a second to re-open it. Such sequences can be executed more rapidly in a procedure since Util Out does not need to go back to the top menu between commands.

Warning: writing to the wrong port can cause a serious malfunction in your computer.

The addresses of the three digital output ports on the DCX-127 module are A, B, and C. See the DCX-127 chapter of this manual for more details.

If a monochrome card with a printer port is present, its address in decimal is 956. A second and third printer port if present would be decimal 888

and decimal 632. If no monochrome card printer port is furnished, the decimal address of the first printer port (treated by DOS as LPT1) is 888 and the second port (LPT2) is 632. Each individual bit line of a printer port is compatible with LSTTL logic. See the "Control of External Devices" section of the PROCEDURES chapter for connector pin information on printer ports.

UTIL WAIT causes a procedure, during execution, to pause until a specific binary word appears at a specific address port in the computer. The purpose of this capability is to synchronize a test procedure with the device under test or some other external event through an unused parallel port or input/output card plugged into the computer. An example could be a procedure which first rewinds a tape machine (by use of Util Out, above), then waits for a signal from the machine that it is fully rewound before continuing through the procedure. Any address port can be specified with any data word (both expressed in decimal), and a "mask" word can also be specified for the cases where the status of some bits of the data word are not important. If the signal from the external device is a single logic line, all other bits could thus be masked off so that the Util Wait function looks only at the single relevant bit.

UTIL DELAY permits the insertion of a specified time delay (in seconds) during a sequence of tests and operations in a procedure. It is typically used to permit a remotely controlled device or fixture to settle into its new condition before the test continues.

UTIL BREAK causes a procedure to halt, returning to the COMMAND menu, when it executes. Util Break is usually used within an If Error statement, to stop a procedure when an out-of-limits measurement is detected.

UTIL LEARN starts the keystroke recording process when creating procedures by learning keystrokes. All succeeding keystrokes will be appended to the procedure until Util End is pressed. If a procedure is already in the procedure editor when you wish to generate a new, unrelated procedure, you should delete the old procedure by marking its

beginning and end with the <F6> key; you can quickly move to the end of the editor via <Ctrl><PgDn>. Util Learn automatically creates the header PROCEDURE (with the software version number) at the beginning of a procedure. Whenever a menu is on screen during the keystroke recording process, the appearance of the menu name will change to remind you that you are recording.

UTIL END terminates the keystroke recording process of generating a procedure.

UTIL PROMPT permits the entry of a message to the operator into a procedure. The message will then appear on the computer screen when the procedure executes. The <Esc> key must be used to return to the keystroke recording process when the prompt has been written. Procedure execution will pause with the message on screen until the <Enter> key is pressed by the operator.

UTIL MESSAGE permits entry of a message which will be written into the error file (if one has been attached to a test by use of the Names Err-file command) when the procedure executes. The <Esc> key must be used to return to the keystroke recording process after the prompt is written.

UTIL GOTO, followed by a line label and <Enter> key operation, causes flow of a procedure to jump to another location in the procedure, rather than simply continuing to the next line. The label is indicated in a procedure by a colon (:) symbol at the beginning of the line. See the PROCEDURES chapter for more information on procedure control flow and examples of use of the UTIL GOTO statement and labels.

UTIL SERIAL-DSP is the only menu command which leads to a third and fourth level. UTIL SERIAL-DSP is functional only with the digital audio inputs and outputs of System One Dual Domain. UTIL SERIAL-DSP permits control over which of three serial modes are to be used for digital domain interface, what type of dither (if any) is to be added to the digital output signal, and also permits control and monitoring of the status bytes used with the

AES/EBU and SPDIF/EIAJ interfaces. See the DIGITAL SIGNAL PROCESSOR chapter and separate DSP program manuals for more information.

UTIL FEED sends a form feed (page feed) command to an attached parallel printer. The intent of the UTIL FEED command is for use when a /F command line option has been used to override normal graph printout formatting. When formatting has been overridden, the printer will simply stop at the bottom of a graph. If desired, a UTIL FEED command may then be used to advance the paper to the top of the next page. See the Hard Copy chapter for more information on graphic printouts and the /F option (page 15-3).

13.11. Compute Menu

COMPUTE: NORMALIZE INVERT SMOOTH LINEARITY CENTER DELTA 2-SIGMA EXCHANGE

COMPUTE functions permit mathematical manipulation of the data in memory from a previously-made test. They can be executed immediately after a test is made, or can be run on test data previously run, saved to disk, and re-loaded.

As a group, the COMPUTE functions replace the original test data with a computed result. If it will ever be desirable to use the original data, save the test before using a COMPUTE function. If the results after using the COMPUTE function are also to be saved, use a different test name to avoid over-writing the original data.

Most of the COMPUTE functions allow numeric arguments to be typed in following selection of the second-level function, before pressing the <Enter> key. The prompt line for entry of these numbers indicates their meaning and whether or not they are optional. Items enclosed in square brackets [] are optional. Items enclosed in parenthesis () describe what information is to be typed in. These arguments and their effect are discussed under each command below.

COMPUTE NORMALIZE *multiplies* every DATA-1 or DATA-2 point in memory, *in the base unit*, by the same value. The base unit is Volts for all amplitude measurements (including distortion, wow and flutter, etc.), Hz for frequency measurements, degrees for phase measurements, and % for relative distortion or wow and flutter measurements. COMPUTE NORMALIZE is normally used only for amplitude measurements, where the data is normally viewed logarithmically (dB, or Volts with a LOG vertical scale). Given that a log display or dB linear is in use, COMPUTE NORMALIZE thus has the visual effect of offsetting amplitude data vertically without changing the shape of the curve.

The multiplier constant used is the value required to bring the data at a specified “horizontal” value (value of the independent variable) to a specified target value expressed in the displayed units.

The form of entry for the command is:

COMPUTE NORMALIZE [*data set*], *horizontal value*, [*target*] <Enter>

Data set, if typed in, must be the number 1 or 2. 1 refers to DATA-1 values (second column in the data editor or table display), 2 refers to DATA-2 values. If no number is entered, the system assumes DATA-1 is to be normalized.

HORIZONTAL VALUE is the point along the independent variable axis (usually SOURCE-1) which is to be exactly at the TARGET after multiplication. Pre-fixes such as k for kilo are permitted.

TARGET is the value after multiplication at the specified horizontal value. The software assumes that the TARGET value entered is in the selected display units for the data column (DATA-1 or DATA-2) being normalized. If no number is entered for TARGET, the system assumes the target to be 1.000 in the basic unit for the parameter measured. Volts is the basic unit for all amplitude parameters—AMPLITUDE, LEVEL, BANDPASS, BANDREJECT, 2-CHANNEL, XTALK. Thus, selecting COMPUTE NORMALIZE with no TAR-

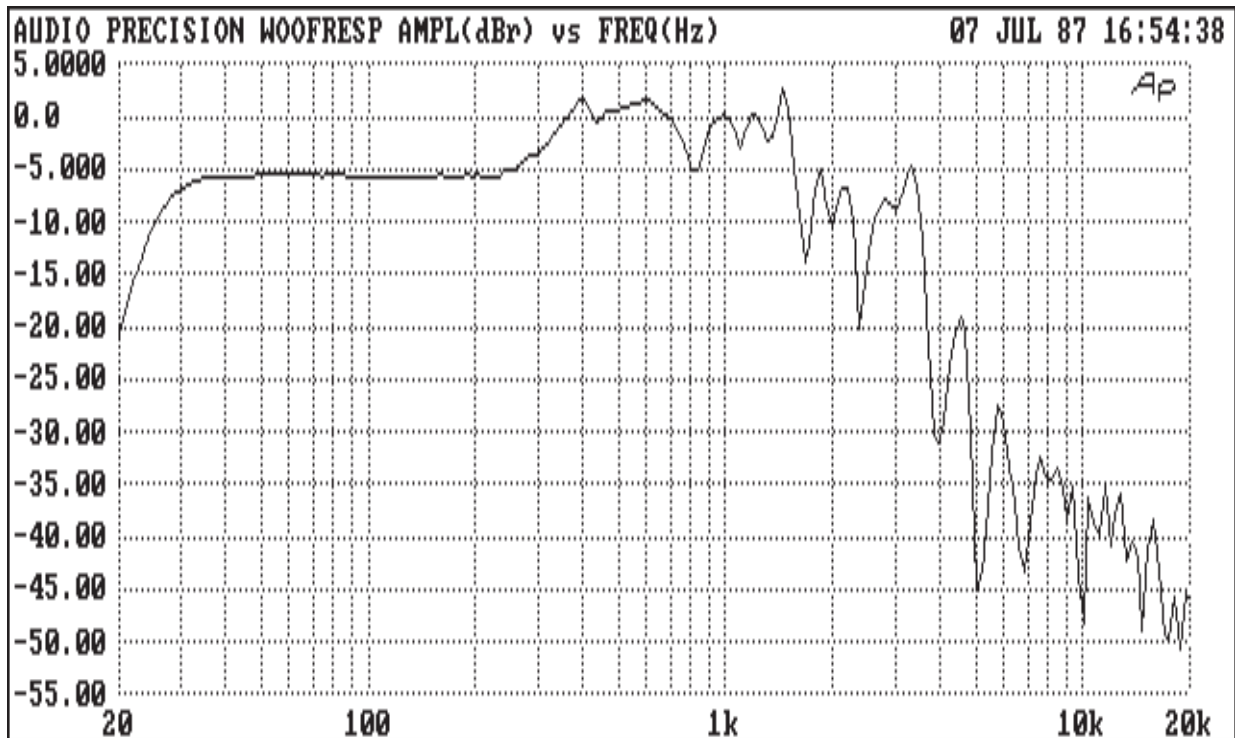

Figure 13-10 Loudspeaker Frequency Response by Sinewave Sweep (201 Points) Before Smoothing

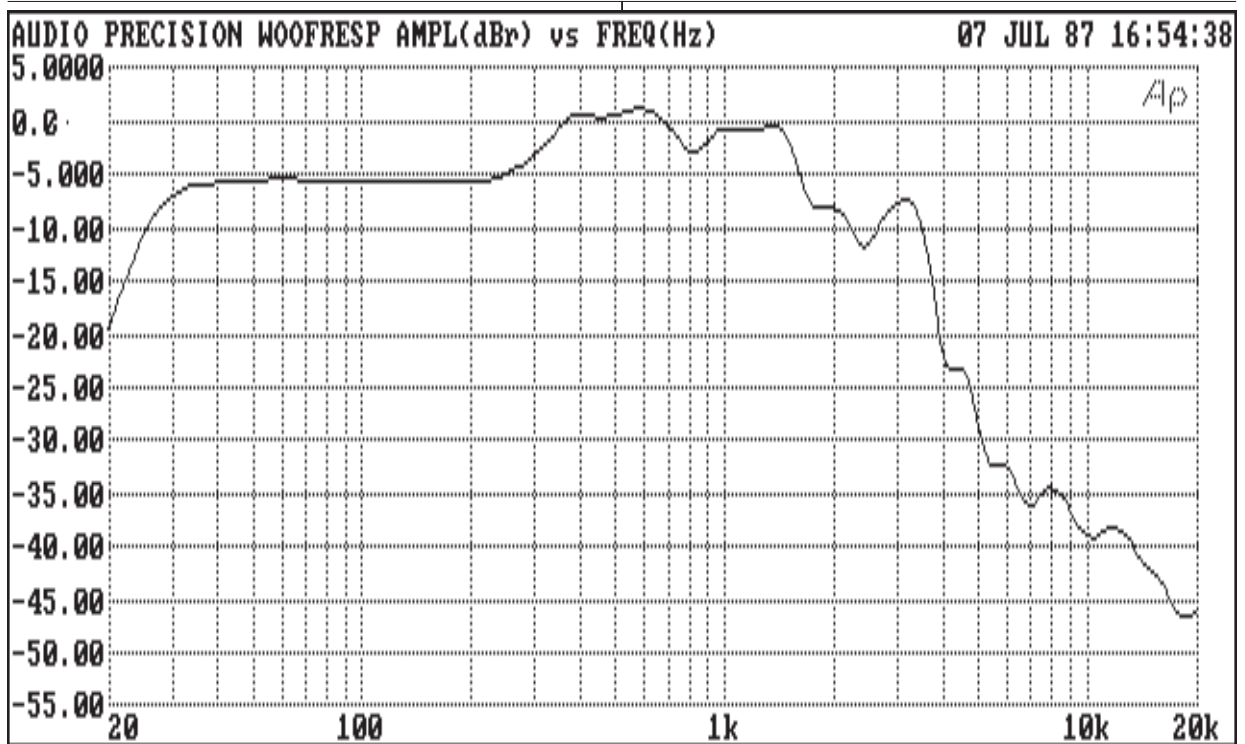

Figure 13-11 Loudspeaker Frequency Response After Default Smoothing

GET value specified will produce data going through 1.000 Volt (zero dBr, +2.2 dBu) at the horizontal value specified.

For example, assume that it is desired to remove the channel imbalance from a frequency response measurement of a stereo device such as a CD player. The DATA-1 value (left channel) already goes through zero dBr at 1 kHz as a result of pressing the F4 key while the 1 kHz reference was playing. To re-align the right channel data, normalize the DATA-2 column so that it also passes through zero dBr at 1 kHz. The command form would be:

```
COMPUTE NORMALIZE 2, 1k, 0 <Enter>
```

One use of Compute Normalize is in preparation of an equalization file (xx.EQ extension) which will not cause a change in generator output level when changing between SINE and EQSINE modes at the specified reference frequency. See the EQUALIZATION chapter for more details on equalization files. Compute Normalize can also be used to standardize an amplitude measurement data file or multiple sets of data files to pass through unity as a common reference point.

COMPUTE INVERT replaces each DATA-1 value in memory with its reciprocal; DATA-2 values, if present, are not affected. It thus “turns over” or inverts the shape of the data curve (assuming that the curve is graphed with decibel or logarithmic Volts units). Compute Invert creates a vertical rotation about a 1.000 Volt (0 dBr) value. The principal intended use of the Compute Invert function is in creating an equalization file for the generator EQSINE function which will exactly compensate for the varying frequency response of the device under test. See the EQUALIZATION chapter for more details and examples on use of this function. No numeric arguments are required or accepted for COMPUTE INVERT.

COMPUTE SMOOTH applies a smoothing algorithm to the data and can also average an entire data file to a single value. The smoothing is a simple running three-point average process. Each set of three adjacent points in the pre-smoothing data is av-

eraged, with the computed average becoming the center of the corresponding points in the smoothed data. The form of the command is:

```
COMPUTE SMOOTH data, [passes] <Enter>
```

DATA, as described above, is 1 or 2 to specify DATA-1 or DATA-2. DATA-1 is assumed if no value is typed in. PASSES describes how many times the smoothing algorithm is applied to the data. This argument is optional. If no value is entered for PASSES, the default selection will be three passes on short tests (up to 63 data points). On longer tests, the default number of passes will be the largest integer in one-half the square root of the number of the points in the data. Any positive integer (one or greater) may be specified for more or less smoothing. Figure 13-10 shows a loudspeaker frequency response measurement before default smoothing and Figure 13-11 after the default smoothing, which was 7 passes in this case.

To average all the data points in a test file, select COMPUTE SMOOTH with the selected data set and any negative number for the second argument; for example:

```
COMPUTE SMOOTH 1,-1 <Enter>
```

The system will average all the DATA-1 points, then replace them all with the computed average value. The graphic result will be a horizontal straight line at the computed average value.

COMPUTE LINEARITY generates a best fit straight line to a specified portion of the data, then calculates the deviation of each data point from that straight line. The line is generated by the least squares method. If only a limited portion of the data is used to generate the line, every data point (including those outside that limited range) is compared to the line. The form of the command is:

```
COMPUTE LINEARITY data, [low, high] <Enter>
```

DATA specifies DATA-1 or DATA-2. LOW and HIGH are optional entries. They define the “window” or portion of the horizontal axis (inde-

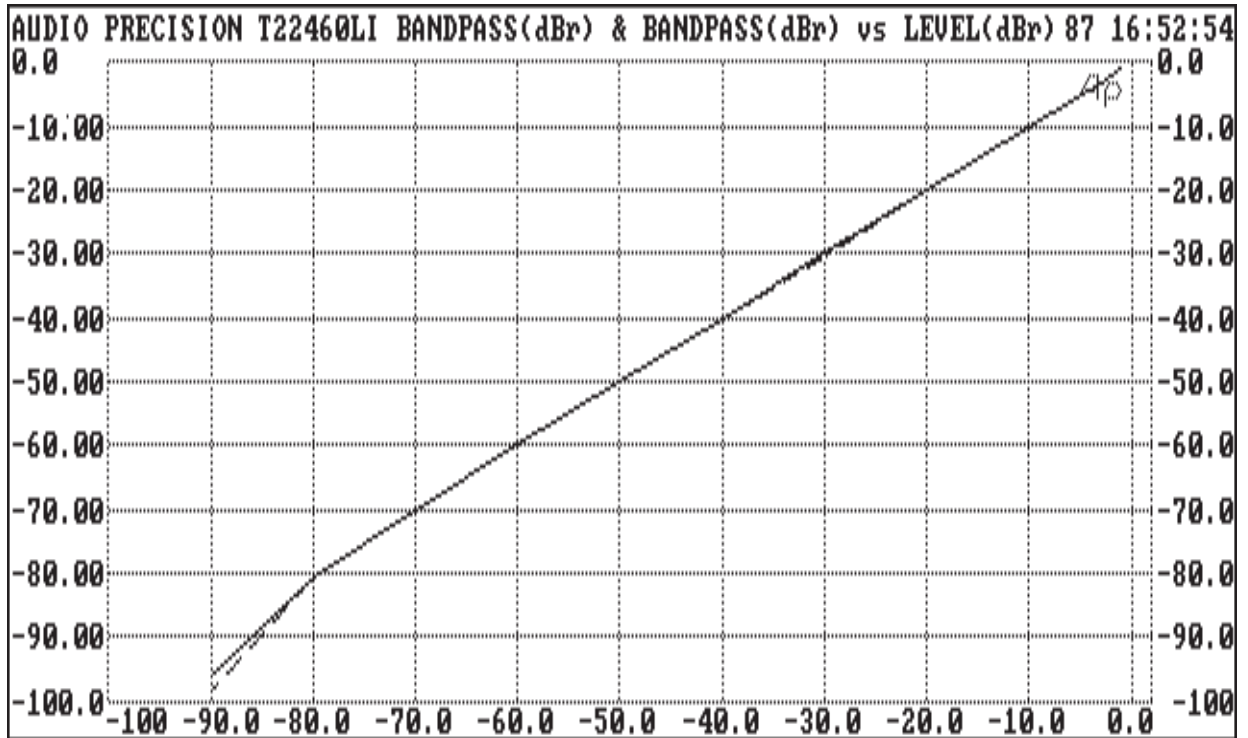

Figure 13-12 CD Player Linearity Test Result

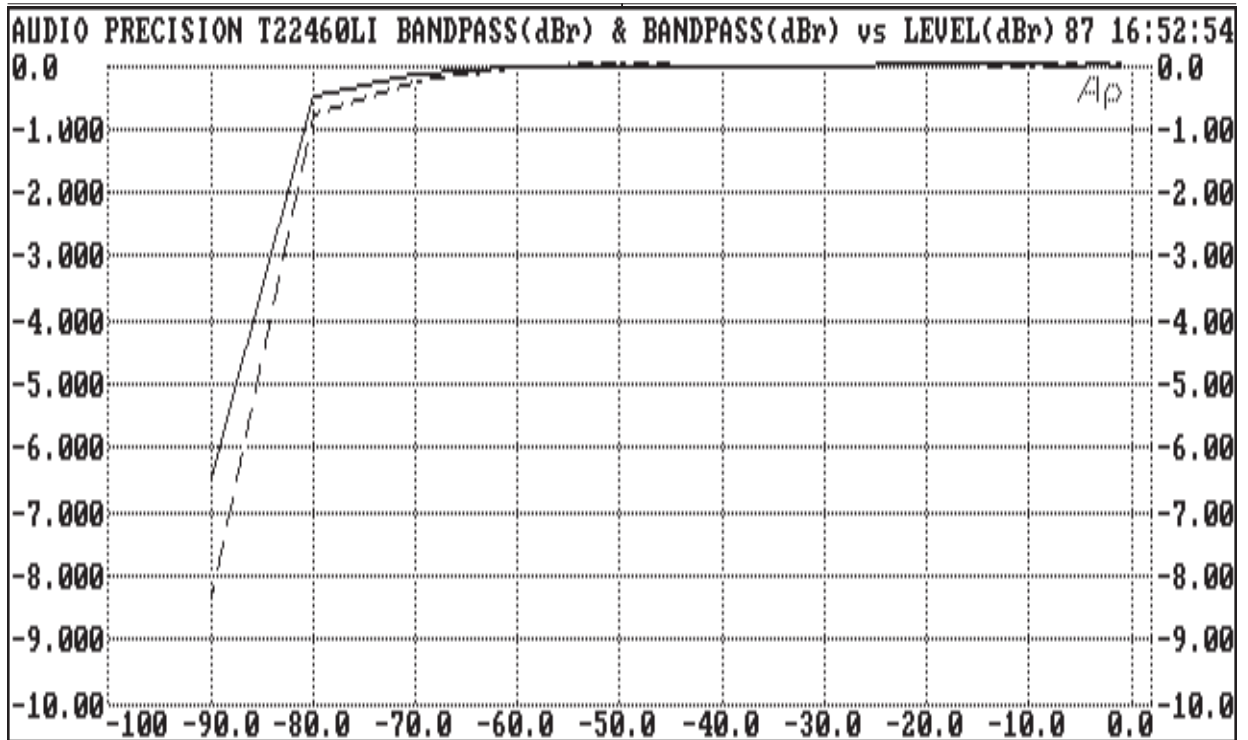

Figure 13-13 Linearity Test Results of Previous Figure, Converted to Deviation from Perfect Linearity by Compute Linearity Command

pendent variable) within which data points will be used to calculate the best fit straight line. If they are not supplied, the line will be fitted to the entire data range.

A good example application of COMPUTE LINEARITY is in linearity testing of compact disc players. Figure 13-12 is an example of a CD player linearity test result, after replacing the column one data with the actual amplitudes on the test disc as supplied by the disc manufacturer. It is thus an accurate measurement of linearity but is difficult to analyze, since a dynamic range of 100 dB is graphed. It can be seen that the linearity is best at the high-amplitude portion of the range, from 0 to -50 dB. The command to compute deviation from best straight line could be:

```
COMPUTE LINEARITY 1, -50, 0 <Enter>
```

Figure 13-13 is the graph after the COMPUTE LINEARITY operation and after changing the DATA-1 GRAPH TOP and BOTTOM from 0 and -100 dBr to +1 and -9 dBr to properly display the deviations from perfect linearity.

COMPUTE CENTER is designed for use with tests that have both upper and lower comparison limit files attached. If COMPUTE CENTER is run after the test has been made, it will move the selected data array up or down as necessary to best center the data between the limits. This is a frequent necessity in microphone testing, where the shape of the response curve is more important than the absolute values (sensitivity). The form of the command is:

```
COMPUTE CENTER data <Enter>
```

DATA specifies DATA-1 or DATA-2, as in most other COMPUTE functions.

COMPUTE DELTA will compute the difference between the data in memory and the data in another file specified by the user. The second file is specified by use of the Names Delta command. This permits calculating and displaying the difference between two tests.

Since COMPUTE DELTA is a subtraction and operates in the displayed units, it is normally used on "linear" data such as phase (degrees) or amplitude expressed in dB. It can be used as a form of analyzer equalization to produce a set of data consisting of a frequency response measurement with an equalization curve subtracted from it, given that both curves were displayed in dB. It can be used to "offset" a phase versus frequency measurement vertically. The form of the command is:

```
COMPUTE DELTA data, data <Enter>
```

The first DATA specifies whether the DATA-1 or DATA-2 values presently in memory are to be the basis of the final result. The second DATA specifies whether the DATA-1 or DATA-2 values of the Names Delta file are to be subtracted from the data in memory. If the second data set argument is not typed in, the system uses the same data set in the DELTA file as in memory.

To compute the difference between frequency response measurements of the two channels of a stereo system (given that the measurements were in dB), use the Names Delta command to name the test itself as the delta file. Run the test and save it via Save Test. Invoking COMPUTE DELTA 1,2 <Enter> or COMPUTE DELTA 2,1 <Enter> will then subtract the specified channel of the test saved to disk from the specified channel of the test in memory. Press <F7> to display the results.

To apply an equalization file to measured test results, the equalization file should first be converted to dBr units with the data going through zero dBr at a reference frequency (usually 1 kHz). The COMPUTE NORMALIZE command may be used to make the .EQ file go through zero at the desired frequency. NAMES DELTA and COMPUTE DELTA are then used for the calculation.

COMPUTE 2-SIGMA is designed specifically for wow and flutter testing. It is common in wow and flutter measurements to take data for a period of seconds or tens of seconds, but to then display or record a single number representing the value which was exceeded for 5% of the time. This is not a true standard deviation approach, although the 5% value

is derived from the fact that in a Gaussian distribution, the two-standard-deviation value will be exceeded only 5% of the time.

The form of the command is:

COMPUTE 2-SIGMA *data* <Enter>

DATA specifies DATA-1 or DATA-2, as usual. DATA-1 is assumed if no value is typed in. The COMPUTE 2-SIGMA operation replaces every data point in the specified column with the same computed value. The computed result can thus be graphed and will always be a horizontal straight line at the computed value.

COMPUTE EXCHANGE interchanges the DATA-1 and DATA-2 sets of values of any test in memory which has data in both areas. It also exchanges the DATA-1 and DATA-2 fields on the SWEEP TEST DEFINITIONS panel. The command is simply:

COMPUTE EXCHANGE

There are no numeric arguments and no <Enter> key operation is necessary. Another form of the command, when in Panel mode, is <Alt><X>. A second operation of COMPUTE EXCHANGE will restore the data columns to their original locations.

A secondary application of COMPUTE EXCHANGE is to simplify panel setup for a STEREO test. In stereo tests, it is usually desired to have identical units, graph top and graph bottom, LOG vs LIN choice, number of divisions, etc., at both DATA-1 and STEREO/DATA-2. Choose the desired module and parameter at DATA-1; for example, LVF1 RDNG. Select the DATA-1 graphic coordinates, units, and other display parameters as desired. Move the cursor to STEREO (DATA-2) and select the same module and parameter as at DATA-1; LVF1 RDNG in this example. Then press either <Esc> COMPUTE EXCHANGE or <Alt><X> (the keyboard "short cut" equivalent to COMPUTE EXCHANGE) and the graphic display parameters from DATA-1 will copy to STEREO/DATA-2. Note that if any data was in memory at the time, the data will also be swapped by the COMPUTE EXCHANGE

or <Alt><X> operation. If only the display parameter copying action is desired without the data swap, operate <Alt><X> or COMPUTE EXCHANGE a second time which will swap the data back to the original positions.

13.12. : (Colon) Line Label Symbol

: The colon (:) symbol, when the first character of a row in a procedure, identifies this line as a label. The name following the : symbol is the name of this line. A UTIL GOTO statement anywhere in the procedure will then cause procedure flow to jump to the location of this label. The : selection in the COMMAND menu permits line labels to be entered into a procedure during UTIL LEARN mode. The name of the label is then typed in, and terminated with the <Enter> key.



14. BARGRAPH DISPLAY

In addition to the numeric readouts at the top of the ANALYZER panel and the line graphs generated during sweep measurements versus amplitude, frequency, or time, System One offers a third type of display. The bargraph display, reproduced as Figure 14-1, provides an analog-like indication of magnitude of up to three measured parameters. It also allows analog-like control of a stimulus parameter (GEN FREQ, GEN AMPL, ANLR BPBR, SWI, DCX DCOU, or DCX DIGOUT) while displaying up to two measured parameters, or two stimulus parameters while displaying one measured parameter.

14.1. Analog Indicators for Adjustments

The principal intended applications of the bargraph screen are cases where the user must adjust the device under test or stimulus to some target value, or simply wishes to monitor a parameter. Common examples are making adjustments in an amplifier for minimum distortion or noise, or adjusting tape head azimuth for maximum output or zero phase. Peaking or nulling operations are much easier with a bargraph than when observing numeric readout. The display update rate in bargraph mode is controlled by the readings per second parameter on the DETECTOR line of the ANALYZER panel. A minimum of 8 readings per second is recommended for good information feedback when making adjustments, and 16 or 32 readings per second may be preferred.

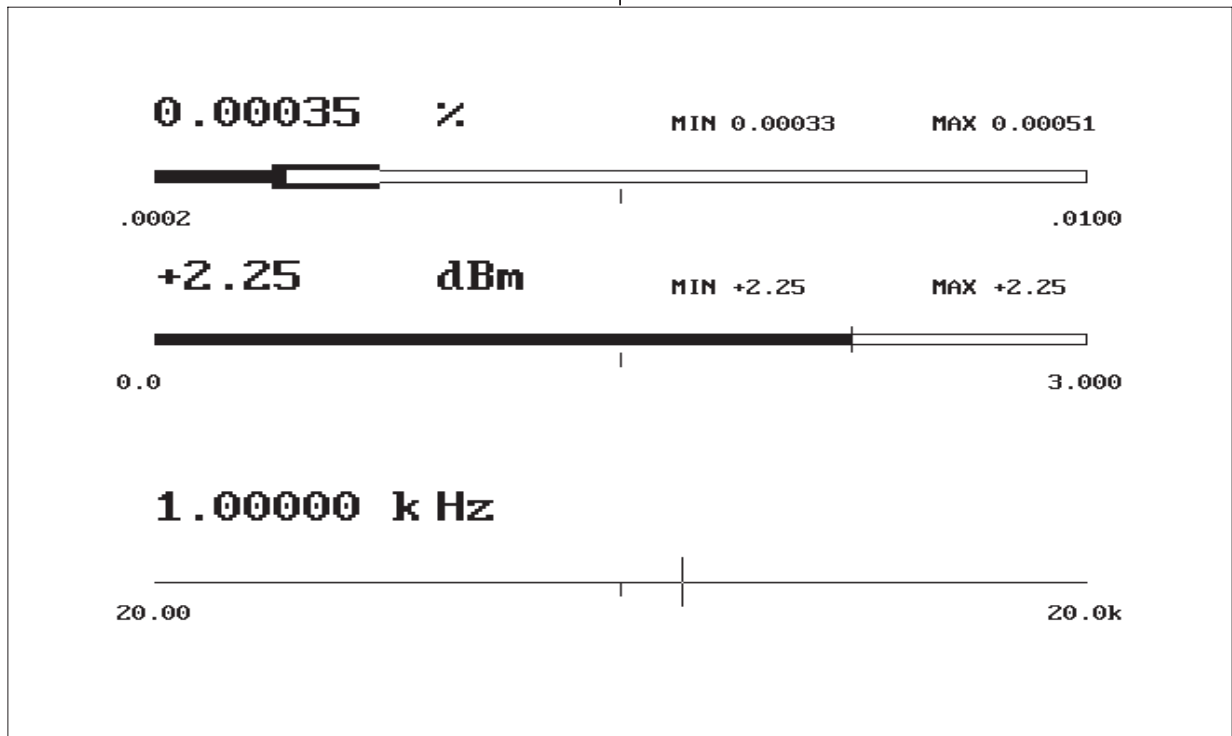

Figure 14-1 Bargraph Display

The bargraph display is obtained by pressing function key <F2> or Run Bargraph. The selections of which parameters will be displayed and of the sensitivity of the display are made from the SWEEP (F9) DEFINITIONS panel. The top bargraph is driven from the DATA-1 selections. The center of the panel may contain a second measurement bargraph driven from the DATA-2 selections, or a stimulus control line when SOURCE-2 replaces DATA-2. The bottom portion of the screen may contain a third measurement bargraph if EXTERNAL AMPL or FREQ is chosen, or can be the primary stimulus control line when SOURCE-1 is selected. Both stimulus control lines can be simultaneously controlled by the mouse or arrow keys. When the stimulus source is GEN FREQ or GEN AMPL, the <+> and keys will also control the SOURCE-1 stimulus by the FREQSTEP or AMPSTEP values.

Note that with original version System One hardware (prior to System One-A), even when STEREO mode is selected on the DATA-2 line, both the top and middle bargraphs will be displaying the same measurement of the channel selected at the top of the ANALYZER panel. It is not possible with the original version of System One to display measurements from both channels of a stereo device simultaneously in bargraph mode. With System One-A hardware, use of the 2-CHANNEL function can provide bargraphs of amplitude on both channels simultaneously. Select either RDNG at DATA-1 and LEVEL at DATA-2, or vice-versa.

For the top two measurement bargraphs, use the DATA-1 or DATA-2 fields to select measurement source, units of display, LOG or LIN, and the bargraph end points. The numbers entered for GRAPH TOP and BOTTOM will set the two ends of the bargraph display. The large digits displayed near each bargraph give the exact value of the measurement. Note that these digits will continue to function, displaying the measurement value, even if the analog display of measurement moves off either end of the bargraph display due to the particular end points selected on the SWEEP (F9) DEFINITIONS panel. As the data varies, note that the outline of the bargraph remains at the highest and lowest values reached to indicate the maximum and minimum

peaks reached by the data. The maximum and minimum values reached are also indicated numerically on the screen. This peak hold feature can be re-set to the current level at any time by pressing the <F2> key or mouse button.

A vertical "tic mark" is located at the exact center of each of the measurement bargraphs, for possible use as a "target" for adjustments. If it is desired to use the mark as a target, the two end points and log or lin shape must be carefully selected on the SWEEP (F9) DEFINITIONS panel so that the midpoint target corresponds to the desired electrical value. In a procedure, it is also possible to mark additional targets or a range by typing onto the bargraph screen; see the end of this chapter for more details.

14.2. Stimulus Control with Bargraphs

The bottom of the bargraph screen can provide either generator stimulus control, analyzer BP/BR filter frequency control, switcher channel control, DCX-127 dc output or digital word output control, or a third measurement bargraph.

For control of a single stimulus parameter, the SOURCE-1 line selection must be the desired stimulus (GEN FREQ, GEN AMPL, GEN tone burst control, ANLR BPBR, SWI, DCX DCOUT, or DCX DIGOUT). The end points and units are set by the START and STOP entries, and the LOG/LIN selection controls the relationship of the cursor position to the parameter. Note that if LOG is selected but either the START or STOP value is negative or zero, the actual calibration will revert to LIN since the LOG of zero and negative numbers is not defined.

The cursor line may be moved back and forth by the horizontal arrow keys (or the mouse, if available). This provides the analog-like control over the variable parameter desirable for operations such as finding the center frequency of a bandpass filter, the frequency of a noise component, or the clipping point of an amplifier. When the stimulus is GEN FREQ, GEN AMPL, SWItcher channel, tone burst

on-time, or tone burst interval, the value and cursor may also be controlled by the increment <+> and decrement keys. Operation of these keys moves generator frequency in FREQSTEP increments, or generator amplitude in AMPSTEP increments. SWITCHER channel is moved in one-step increments, which is very convenient when aligning multi-track tape recorders. Tone burst "ON" and interval values are moved in steps of one cycle when the units are cycles, one second when the units are seconds, one percent when on-time is expressed in percent duty factor, and one burst per second when interval is expressed in Bps.

The initial location of the stimulus cursor is determined by the numeric entry on the panel for that stimulus parameter (AMPLITUDE or FREQUENCY value on the GENERATOR panel, BR/BR FREQ on the ANALYZER panel, DCOUT1 on the DCX panel, switcher channel on the SWITCHER panel, etc.). Upon exit from the bargraph display (via <Esc> or <Enter>) to the panel, the cursor value sets the panel value. The <Ctrl> and <Shift> keys magnify the movement of the cursor caused by the arrow keys. Operation of the horizontal arrow keys will cause a one-step change in the generator. <Ctrl> arrow key will cause a 5-step change; <Shift> arrow key will cause a 25-step change. Setting resolution is limited to 1 part in 500 by the horizontal graphic resolution of the screen. The sensitivity of amplitude or frequency to cursor movement can be adjusted by proper selection of the end points on the SWEEP (F9) DEFINITIONS panel.

When GEN FREQ or GEN AMPL is the SOURCE-1 selection, sensitivity of cursor movement caused by the increment <+> and decrement keys is determined by the FREQSTEP and AMPSTEP values entered on the GENERATOR panel. One application of this feature is to permit any arbitrary frequency or amplitude change with one keystroke. For example, if the adjustment process for an audio device requires repeated amplitude measurements at 1 kHz and 10 kHz, FREQSTEP could be selected as 9 kHz on the GENERATOR panel. The GENERATOR panel would be set to 1 kHz. Bargraph mode is then selected with an amplitude display at DATA-1 or DATA-2 and GEN

FREQ selected as SOURCE-1. The frequency can be instantly toggled back and forth between 1 kHz and 10 kHz with the increment and decrement keys while making adjustments on the device and observing the results on the bargraph.

14.2.1. Simultaneous Amplitude and Frequency Control

When it is desired to control both generator amplitude and frequency (or any other combination of two stimulus parameters) from the mouse or arrow keys, select GEN FREQ at SOURCE-1 as described above; near the center of the SWEEP (F9) DEFINITIONS panel, change DATA-2 to SOURCE-2, change ANLR to GEN, and select AMPL as the GEN parameter. Only one measurement parameter may be selected in this mode, as selected at DATA-1. When you press <F2> (or Run Bargraph) to go to the bargraph screen, you will find a generator amplitude line and cursor at the screen center and a generator frequency line and cursor at the screen bottom; see Figure 14-3 for an example. "Vertical" motion of the mouse (along its long axis) will control amplitude, and horizontal motion of the mouse will control frequency. The vertical and horizontal arrow keys will also control these parameters; note that <Ctrl><vertical arrow> is not defined by the IBM keyboard, and therefore cursor movement magnification with the vertical arrow keys is limited to the <Shift> key. The increment <+> and decrement keys affect only the SOURCE-1 parameter.

14.3. Three Parameter Bargraphs

The bottom of the bargraph screen can also display frequency, or amplitude as measured by the LEVEL voltmeter, resulting in three parameters being measured and displayed as bargraphs simultaneously. To make the bottom into a measurement bargraph instead of generator stimulus control, select EXTERNAL instead of GEN as SOURCE-1. Select either FREQ or AMPL to be displayed, select the desired units, use START and STOP to control the end points, and select STEP TYPE LOG or LIN as desired. See Figure 14-2 for an example.

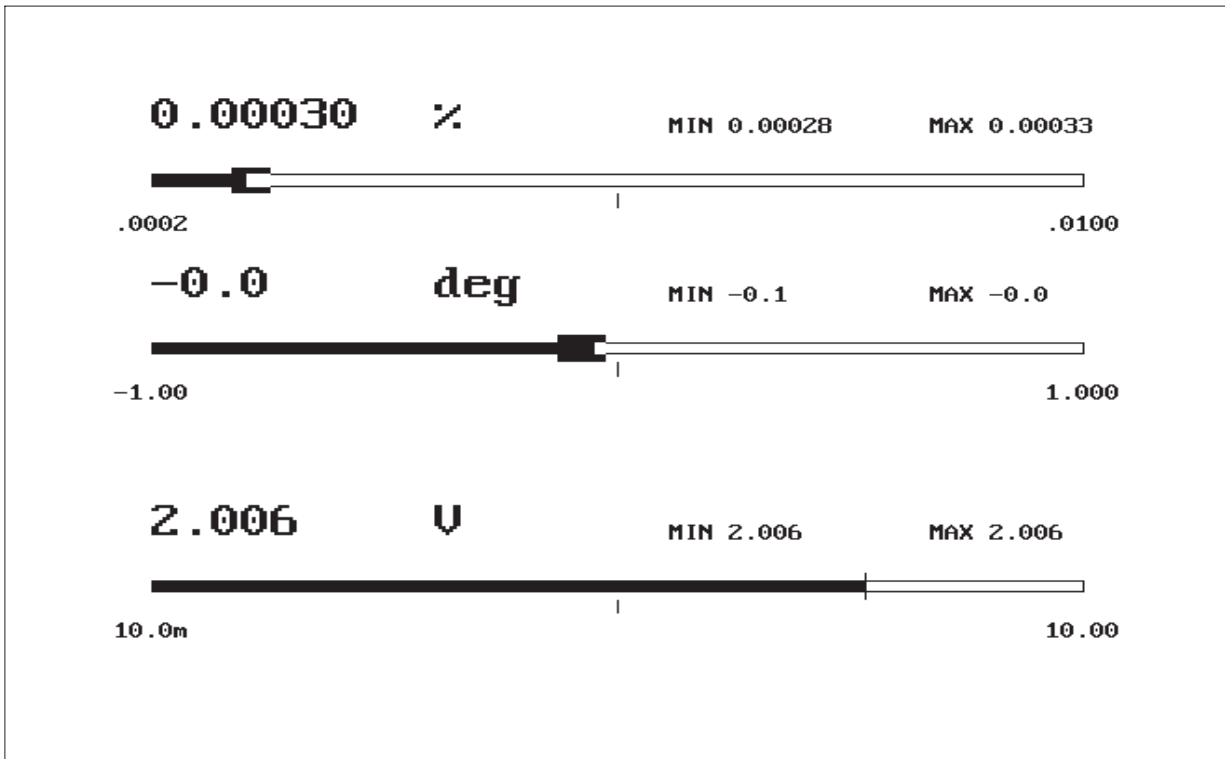

Figure 14-2 Bargraph with Three Measurement Parameters

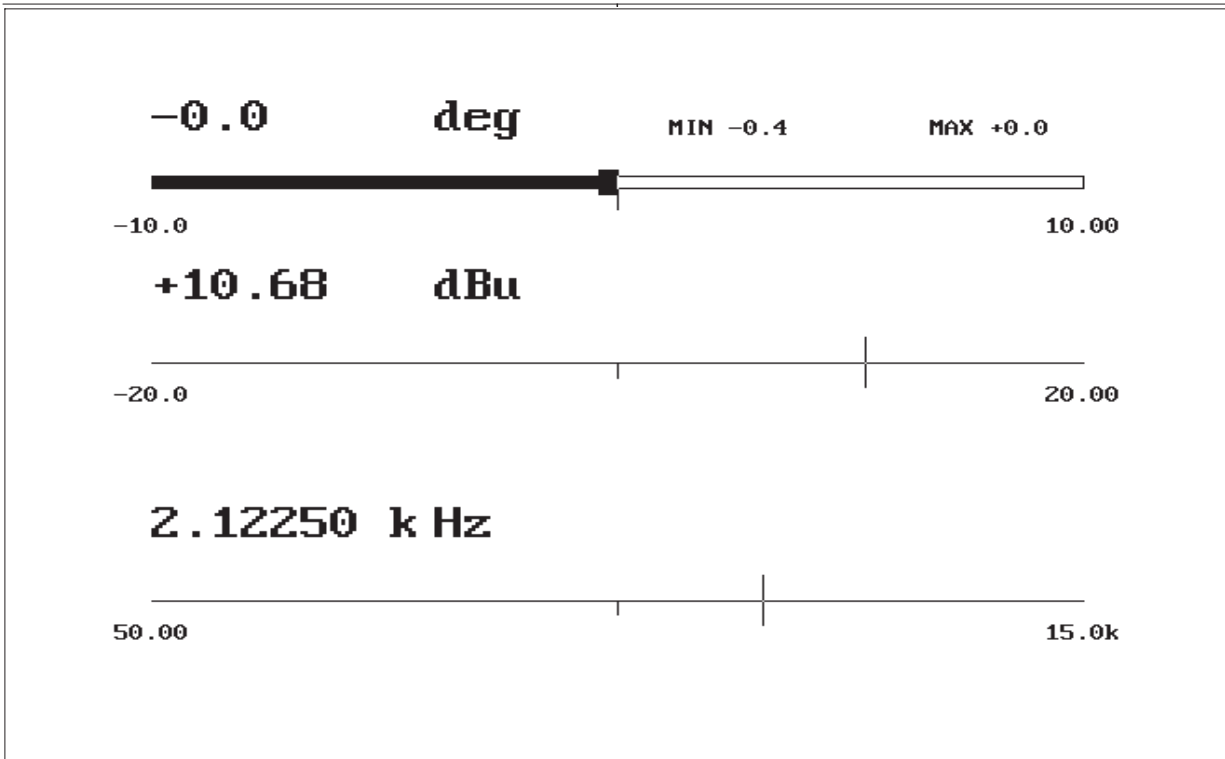

Figure 14-3 Bargraph for Simultaneous Generator Amplitude and Frequency Control

use the <PrintScr> key. Any prompts and the maximum and minimum indications will also print out, as will any comments in the comments editor at the time the <*> key was pressed.

15. HARD COPY PRINTOUT

15.1. Introduction

If you have a compatible dot matrix printer or HP LaserJet connected to your computer via the parallel interface, you can obtain paper printout of test graphs, bargraphs, tabular data, and setup panels. These printouts can be made at a single key push from within S1.EXE software. Resolution of the graphs will be no better than the resolution of the computer display system (pixel limited).

Graph printouts (not panels or tabular data) can also be obtained via RS-232-connected HPGL-compatible plotters (in multi-pen colors), RS-232-connected PostScript laser printers such as the Apple

LaserWriter, and RS-232 or parallel connected HP LaserJet laser printers. These are vector-drawing devices and the graphic resolution will be limited only by the output device and the number of points taken in the measurement. The plotter and laser printouts are obtained by exiting or quitting S1.EXE software, then running another Audio Precision-furnished program to define and execute the printing. For the HP LaserJet II, an additional hardware or software product (not furnished by Audio Precision) is required which effectively converts the LaserJet to HPGL format. An HP LaserJet III with two megabytes of memory can operate directly in HPGL mode.

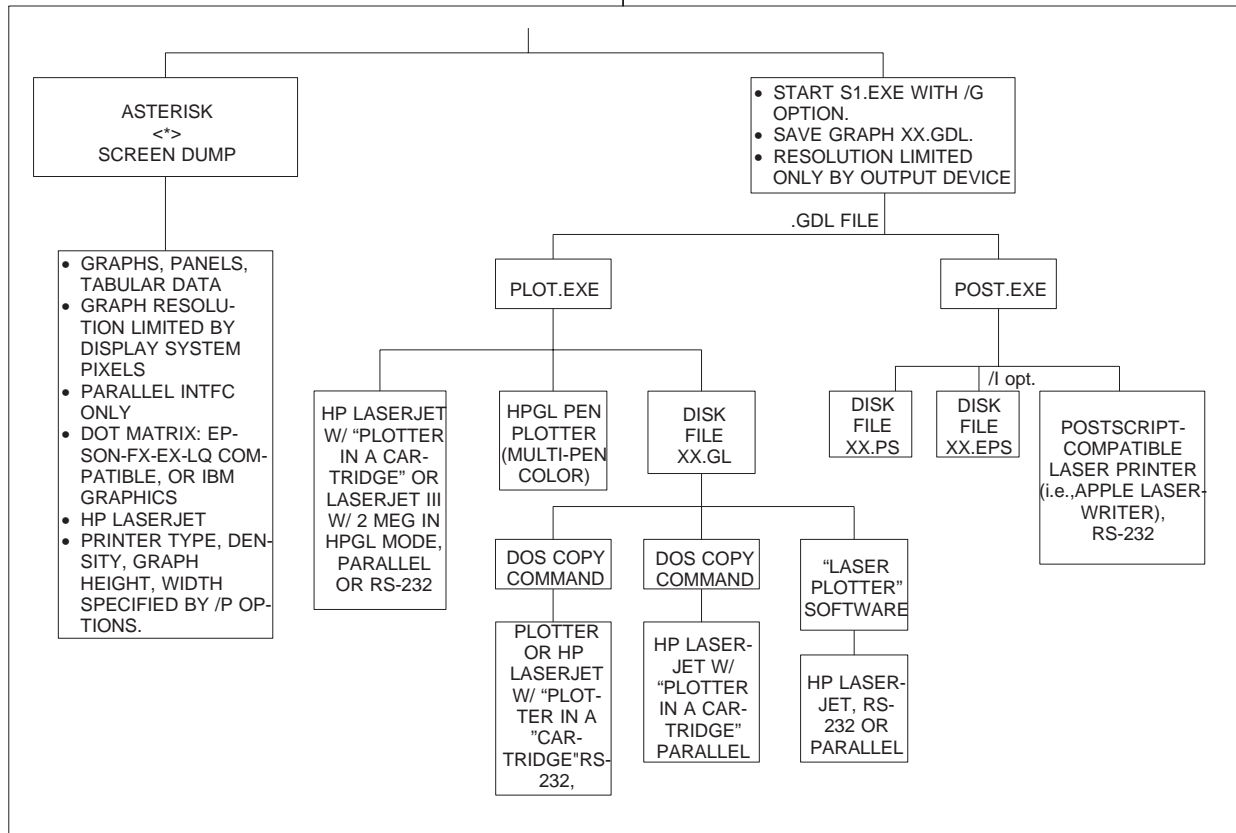

Figure 15-1 Representation of Hard Copy Print-Out Modes and Devices Supported by System One Software

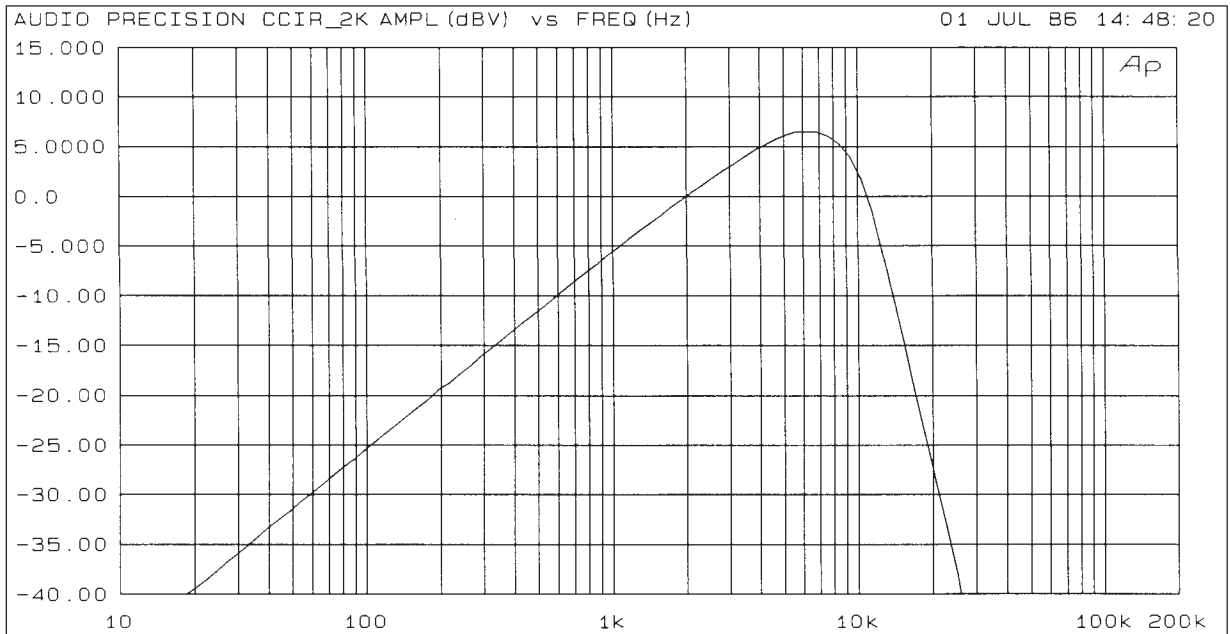
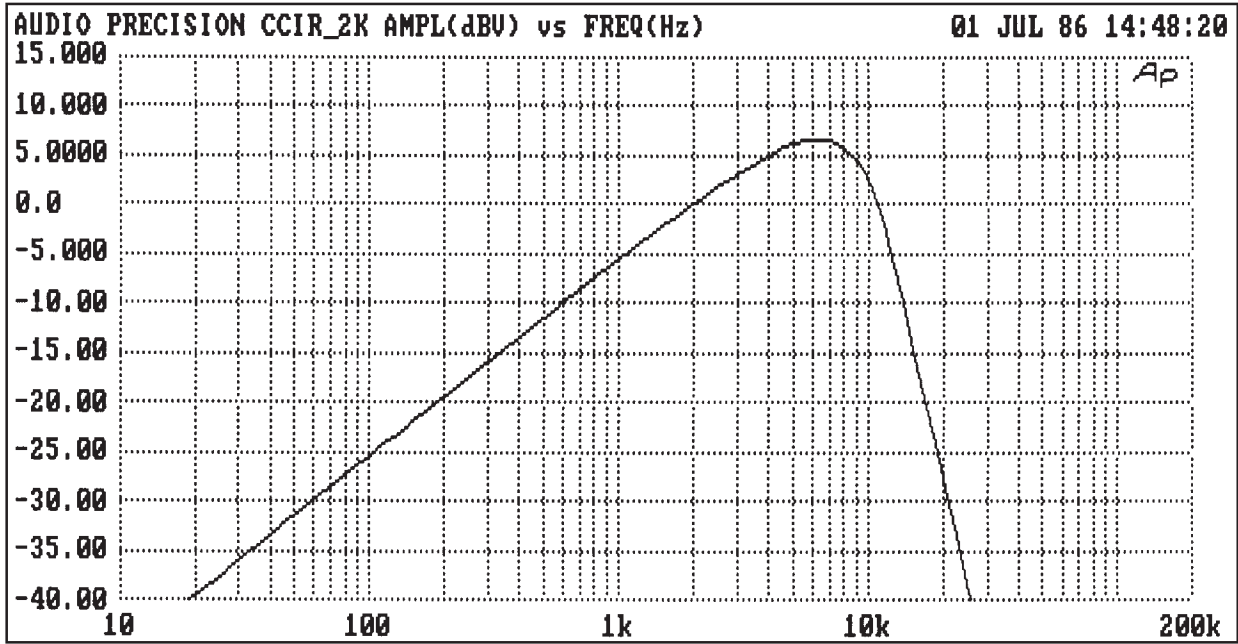

Figure 15-2 Pixel-Limited and Vector Mode HP Laserjet Printed Graphs

See Figure 15-1 for a representation of the various modes of obtaining hard copy. Detailed descriptions follow in the remainder of this chapter.

See Figure 15-2 for an illustration of the same graph, printed via screen dump (CGA graphics system, 640 x 200 pixel limited) and via the PLOT program (vector drawing). An HP LaserJet was used in both cases. High-resolution illustrations produced by both POST and PLOT may be seen in Figure 15-6 and Figure 15-9.

15.2. Pixel-Limited Screen Dump Graphs and Comments

A parallel-connected (LPT1:) IBM Graphics printer, Epson FX, EX, or LQ or fully compatible dot-matrix printer, or an HP LaserJet-compatible printer is required for print outs. With a graph on screen which you would like to print, press the <*> (asterisk) key. You may use the shifted numeral 8 key above the alphabetic keys or a separate <*> key if your keyboard has both. On keyboards with a separate <PrintScrn> key, do not use the <PrintScrn> key for printouts from System One software. The graph should print in 20 to 40 seconds on most dot-matrix printers, depending on the speed of your printer. The end of transmission to the printer is signalled by a "beep" from the computer; the printer will continue printing until it has emptied its buffer. Speed to an HP LaserJet will depend upon the selected dot density. To abort print-out, press the <Esc> key. If the graphics cursor was displayed when the <*> key was pressed, the cursor and its numeric read-outs will be part of the printed information.

If there is text in the Edit Comments buffer, it will print immediately below the graph in * screen dump mode. Text is entered into the comments buffer via the Edit Comments feature; see the EDIT section of the MENUS chapter for more details. If the position of the print head after printing the graph and comment text is not more than halfway down the page, the system will not do a page advance after the printout but will advance to a vertical center page position. The next <*> operation will then print the next graph (and comments, if any) on the

same page. If this automatic multiple-graph-per-page mode is not desired, S1 software can be loaded with the /F command line option which over-rides this formatting.

15.2.1. /F Option

Print-out formatting and bi-directional print modes can be controlled by use of the /F option at startup of S1.EXE. The general format of this option is /Fn,n where each "n" may take the value of 0 or 1.

The first number controls formatting. The digit 1 produces formatted printout; the digit 0 disables formatting. The following table explains the differences between formatted and unformatted printout:

GRAPH	FORMATTING ON (1)	FORMATTING OFF (0)
Top Margin	1 line	starts at present print head vertical position
Left Margin	graph is centered by use of leading spaces	centered as when formatted
Page Breaks	comments text under graph will skip one line at end of each page	continuous lines of comments text, no lines skipped
Form Feeds	sends form feed after 2nd, 4th, 6th, etc. graphs and after comments text if comments text extends beyond 1/2 page	no form feeds
PANELS	FORMATTING ON (1)	FORMATTING OFF (0)
Top Margin	4 lines	starts at present position
Form Feed	sends form feed after 2nd, 4th, 6th, etc. graphs and after comments text if comments text extends beyond 1/2 page	no form feeds
Space between panel printouts	6 lines	none

Note that when automatic form feeds (page advances) are disabled by the /F option, the operator may manually or in a procedure cause a form feed at any desired point by use of the Util Feed menu command.

The second digit controls bi-directional printing. The digit 1 produces bi-directional printout, where the print head moves from left to right on one pass and right to left on the next pass. This mode produces the fastest printout. The digit 0 causes uni-directional printout. While slower, uni-directional printout will produce higher quality graphs on some printers which tend to produce vertical lines with a degree of "waviness" in bi-directional mode.

For example, the command to start System One software with formatting disabled and uni-directional printout would be:

```
S1 /F0,0 <Enter>
```

If the /F option is invoked without a digit following, it is equivalent to /F0,1 (formatting disabled, bi-directional printing).

15.2.2. Graph Size Selection and Printer Compatibility

Graphic printout of any desired height and width can be obtained by use of the /P option when S1.EXE software is loaded. Figure 15-3 lists the command line printer specification codes, the printer modes supported by S1.EXE, and the horizontal and vertical dot density produced by the printer in each mode. The first four modes (codes 0 through 3) are supported by both IBM and Epson (or Epson-compatible) printers. The next four modes (codes 4-7) are available only in Epson and Epson-compatible printers. Modes 8-18 are available only in the Epson LQ series and LQ-compatible (24-pin) printers. Modes 19-22 support the HP LaserJet and compatibles at several different dot densities.

To specify a printer mode and graph size other than the default value, the software must be started with the /P option followed by three numbers separated by commas:

```
S1 /P#,#,# <Enter>
```

The first number is the printer code selected from Figure 15-3. The second and third numbers are the desired height and width of the graph (in inches). To obtain a 3 inch high by 5 inch wide graph in mode 2, for example, the software would be started:

```
S1 /P2,3,5 <Enter>
```

Batch files or the DOS Environment area may be used to specify the printer mode and graph size automatically, rather than requiring these characters to be typed each time the software is started. See the CREATING YOUR CUSTOM SOFTWARE START-UP PROCESS Chapter, beginning on 28-1, for details.

15.2.3. Graph Quality vs Size, Printer Mode, and Display System

Completely arbitrary selection of printed graph size will not generally produce the highest quality result. This is because both the computer display system and the printer are dot matrix devices. For the printed image to offer the full detail of the screen, every dot (pixel) of the display screen must map to a single dot or fixed number of dots in the printer. If the screen dot-to-printer dot mapping is not an integral ratio such as 1:1, 1:2, etc., the software must periodically round off to an adjacent dot as the printout is made. The result will be one or more distorted areas in the graph, consisting of doubled lines, distorted characters, etc.

In order to select graph size for undistorted printout, you must know the graphic resolution of your graphics display system and the available resolution(s) of your printer. Figure 5-2 on page 5-7 shows the horizontal and vertical full-screen resolution of the various graphics display systems supported by S1.EXE.

For example, assume your graphics system is CGA-compatible with a MONO-GRAPH display. From Figure 5-2, you can determine that the screen displays 640 dots horizontally across its full width and 200 dots across its height. Assume that your

SCREEN DUMP (ASTERISK) PRINT MODES OF S1.EXE SOFTWARE			
MODE	DESCRIPTION	HORIZ. RES. (dots/in.)	VERT. RES (dots/in.)
/P0	IBM/Epson single density	60	72
/P1	IBM/Epson low speed double density	120	72
/P2	IBM/Epson high speed "double" density	120	72
/P3	IBM/Epson quadruple density	240	72
/P4	Epson "CRT 1"	80	72
/P5	Epson 1:1 (plotter)	72	72
/P6	Epson "CRT 2"	90	72
/P7	Epson dual density plotter	144	72
/P8	Epson LQ single density 8 wire	60	60
/P9	Epson LQ low speed double density 8 wire	120	60
/P10	Epson LQ high speed double density 8 wire	120	60
/P11	Epson LQ quadruple density 8 wire	240	60
/P12	Epson LQ "CRT 1" 8 wire	80	60
/P13	Epson LQ "CRT 2" 8 wire	90	60
/P14	Epson LQ single density 24 wire	60	180
/P15	Epson LQ double density 24 wire	120	180
/P16	Epson LQ "CRT 3" 24 wire	90	180
/P17	Epson LQ triple density 24 wire	180	180
/P18	Epson LQ hex density 24 wire	360	180
/P19	HP PCL (LaserJet)	75	75
/P20	HP PCL (LaserJet)	100	100
/P21	HP PCL (LaserJet)	150	150
/P22	HP PCL (LaserJet)	300	300

Figure 15-3 Command Line /P Options for Print-Out Control

printer supports mode 2, with 120 dots/inch horizontal and 72 dots/inch vertical resolution. The acceptable printed graph heights are those sizes which result in an integer ratio of $\frac{\text{screen dots}}{\text{printer dots}}$. For the vertical axis, the smallest graph height which will show full screen resolution is $200/72 = 2.7777$ inches. Other acceptable heights are integral multiples of this value: 5.5555 inches, 8.3333 inches, etc. The smallest printed width for full screen resolution is $640/120 = 5.3333$ inches. To select mode 2 with a 2.7777 inch height and 5.3333 inch width, start S1 as follows:

```
S1 /P2,2.7777,5.3333 <Enter>
```

15.2.4. Landscape and Portrait Orientation Graphs

To obtain graphic printout with the graph rotated 90 degrees, add 100 to the printer code selected from Figure 15-3. This is commonly referred to as landscape mode, where the paper would be held with its long axis horizontal while viewing the graph. For example, to use printer mode 2 but with a 90 degree rotation of the printout, and to obtain a large 8 inch by 10 inch graph, start the software:

```
S1 /P102,10,8 <Enter>
```

The contents of the Edit Comments buffer will not print out in landscape mode. Note that height and width are relative to the paper, not to the graph, and thus are effectively interchanged in landscape orientation. The example immediately above therefore produces a landscape orientation graph 8 inches high by 10 inches wide.

The normal mode supporting two graphs per page is referred to as portrait mode, where the paper is held with its long axis vertical while viewing graphs.

15.2.5. Graphs Without Grids

To prepare original graphs for multi-color printing, it is necessary to have one original for each color of the final process. S1.EXE software can be started with the /- option, resulting in <F7> or <F9> producing a graph with no grid, calibration marks, or alphanumeric text. The box around the graph is displayed for use as an alignment guide. A printout of this display can be used for one color separation (data line only). With a normal software load (not using the /- option), an empty grid can be displayed and printed without data. This can be used for a second color, or in black.

15.2.6. Tabular Data Printout

At the conclusion of a Run Test <F9> or Run Graph <F7> operation with any test file or panel where DISPLAY TABLE is selected on the SWEEP (F9) DEFINITIONS panel, pressing the <*> key will cause the data to print to the printer in the same format as displayed on screen. Single point tabular data will also be printed by the <*> key if SOURCE-1 is set as GEN NONE, since this mode automatically produces tabular output on screen. Out-of-limits values and TIMEOUT or UNREGULATED flags will thus also print, just as they display on screen. The full set of data will print, even if longer than one full screen. The data will not print point-by-point in real time as it is taken, but all points will print at the conclusion of the last point of the test. No line feeds or page advances are sent at the conclusion of a tabular printout. Tabular print-

outs are compatible with any printer which is compatible with the computer, rather than the more limited compatibility of graphics printouts.

Since many printers have internal buffers which hold several lines of text, a procedure with tabular printouts may run with almost no delay compared to the same procedure with no printout, since the preceding test data can be printing while the next test is running.

15.2.7. Panel Printout

You may obtain a printout of the setup panels or a bargraph screen by pressing the <*> key whenever the desired panels or bargraph are on screen.

15.3. High Resolution Plotter and Laser Printer Output

High-quality graph printouts can be obtained to certain plotters and laser printers. The resolution of such graphs is unlimited by the resolution (pixels) of the computer graphics adapter. These graphs are not obtainable directly via S1.EXE software, but require running an additional program also furnished by Audio Precision. *Unlike the screen dump printouts, graphics cursor information* (see page 11-9) *is not reproduced as part of a plot or print made in this mode.* Unlike the screen dump print-outs, the contents of the comments editor do not print via the high-resolution modes as they do with the screen dump. When the HP LaserJet III is the printer, there is a method of obtaining comments print-out; see page 15-15 below. These high-resolution modes support only graphs, not panels or tabular data.

S1.EXE must be started with the /G option to enable graph data reporting to a file which will then be used by either PLOT.EXE or POST.EXE, depending on which type of plotter or laser printer is to be used. To start S1 in the graphics reporting mode, from the DOS prompt, type:

```
S1 /G <Enter>
```

When started in this mode, the SAVE GRAPHICS menu command is enabled. By executing SAVE GRAPHICS and supplying a file name, graph information will be stored to disk in a file with the extension .GDL (Graphics Display List). This file contains information on all text and lines on the graphics screen which was saved.

15.3.1. Plotter and HP LaserJet Laser Printer Output

PLOT.EXE is furnished as part of System One's standard software. It drives any HPGL-compatible plotter. The HP LaserJet III with two megabytes of memory can directly function as an HPGL plotter. PLOT also drives HP LaserJet II laser printers which are equipped with the "Plotter In A Cartridge" product from:

Pacific Data Products
6404 Nancy Ridge Drive
San Diego, CA 92121
telephone (619) 552-0880.

Alternately, HP LaserJet printers can be driven by a software product called "Laser Plotter", manufactured by:

Insight
1024 Country Club Drive, Suite 140
Moraga, CA 94556
telephone (415) 376-9451
FAX (415) 631-0595.

"Laser Plotter" is available both from the manufacturer and from Hewlett-Packard. "Laser Plotter" uses as its input a .GL file saved by PLOT.EXE. See the section on page 15-16 for more information on using this method.

PLOT is normally started from the DOS prompt simply by typing:

```
PLOT <Enter>
```

For an HP LaserJet III with two megabytes of memory and operating in HPGL emulation mode, PLOT should be started with the "/3" option:

```
PLOT /3 <Enter>
```

PLOT is normally able to determine the type of display system in the computer and configure itself accordingly. If the automatic configuration does not work properly, the /D option may be used at startup to force selection of a particular display mode. For example, to force configuration for a Hercules monochrome display system the /D1 option is required and the software would be started with the command:

```
PLOT /D1 <Enter>
```

See the Graphic System Compatibility section beginning on page 5-7 for full details.

PLOT can be run after quitting S1.EXE software. PLOT may also be run during an XDOS or DOS temporary exit from S1.EXE. In this case, S1.EXE must have been started with the /R, /B, or /&filename options so as to leave sufficient memory available to DOS for operation of the program. The PLOT program itself occupies about 100 kbytes of memory, plus an additional amount which depends upon the complexity of the image to be plotted. This additional amount may be estimated by assuming 3 kbytes for the empty grid plus text and 16 bytes per data vector. For example, a 100-step graph with both DATA-1 and DATA-2 in use would have 100 vectors per data value or 200 vectors total, requiring 3200 bytes. The total memory requirement in this case would be 100 kbytes for the program, 3 kbytes for the blank grid, and 3.2 kbytes for data vectors for a total of about 106 kbytes. A common large memory requirement is likely to occur when plotting FFTs which may have as many as 500 points to plot (8 kbytes for the data). Nested sweeps or appended tests with many lines on the graph may also have large memory requirements. See the CREATING YOUR CUSTOM SOFTWARE START-UP PROCESS Chapter (starting on page 28-1) for more information on the /R, /B, and /&filename options.

Note also that your disk, in the current directory, must have space available for temporary files created during the operation of PLOT.EXE. This tem-

porary file (APTEMP\$.GL) will be approximately four times the size of the input .GDL file which PLOT is using.

15.3.1.1. Interactive Mode

When PLOT loads, an introductory screen will display along with the menu choices across the bottom as follows:

```
CMD: POSITION ATTRIBUTES OUTPUT
SAVE LOAD QUIT
```

This menu operates similarly to S1.EXE's command menu. The <Space> bar, horizontal arrow keys, or mouse may be used to move the cursor to the desired selection and the <Enter> key used to make the selection. Alternately, a selection may be made by pressing the key corresponding to the first

character of the command. Returning to this menu from any screen within PLOT is accomplished by the <Esc> key.

15.3.1.2. Position Panel

When POSITION is selected, a screen similar to Figure 15-4 will be displayed. The arrow keys or mouse may be used to move a cursor onto each field which can be changed. Some fields are multiple choice, while others accept numeric entry from the keyboard.

The PAPER SIZE field permits selection of the paper onto which the plot or laser printout will be made, ranging from U.S. sizes A through E (European A4 through A0).

ORIENTATION permits selection of the orientation of the graph with respect to the paper. In PORTRAIT mode, the paper must be held with its long

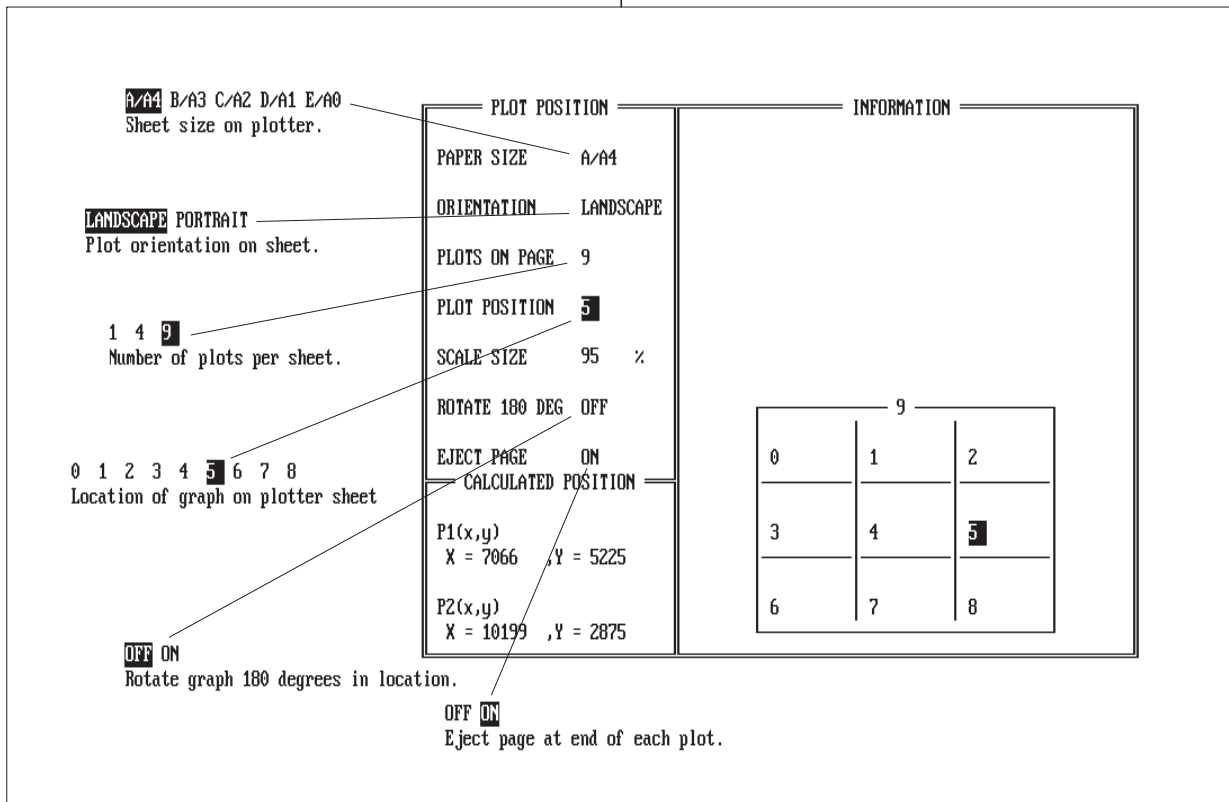

Figure 15-4 Position Panel, PLOT.EXE

axis vertical for the graph to be normally viewed. In LANDSCAPE mode, the graph will be normally viewed with the paper's long axis horizontal.

PLOTS ON PAGE permits selection of a single or multiple plots on a page. Normally, each plot would be a different graph. The number of plots and relative orientation of the plots depends upon which paper size has been selected and whether landscape or portrait mode has been selected. The alternatives are clearly illustrated in the right portion of the screen. The PLOTS ON PAGE entry will be superceded by making specific entries into the CALCULATED POSITION fields below.

PLOT POSITION selects which of the multiple positions a graph will be printed/plotted onto during the current printing/plotting session. If only one plot per page has been selected, only the 0 selection is available. With a multiple plot selection, the right side of the screen illustrates the position numbering

scheme. The PLOT POSITION entry will be superceded by making specific entries into the CALCULATED POSITION fields below.

SCALE SIZE selects the size of plot or print. The aspect ratio (horizontal-to-vertical size ratio) will be 4:3 for any scale size entered. Any numeric value may be entered for scale size. The default value of 95% creates a small amount of space between multiple plots on the same page. The scale size value will be superceded by making specific entries into the CALCULATED POSITION fields below.

ROTATE 180 DEG permits definition of which edge of the paper the top of the graph is oriented toward. Use of this field plus the LANDSCAPE/PORTRAIT choice above lets a graph be plotted or printed in any of the four possible orientations with respect to the paper.

LINESYLE					TEXT	
	PEN #	STYLE #	SIZE %	WIDE		PEN #
DATA-1					TEXT	
TRACE 1	= PEN 2	+ STYLE 7	+ 4.0	+ 1	GENERAL	= PEN 1
TRACE 2	= PEN 2	+ STYLE 6	+ 4.0	+ 1	DATA-1	= PEN 2
TRACE 3	= PEN 2	+ STYLE 5	+ 4.0	+ 1	DATA-2	= PEN 3
TRACE 4	= PEN 2	+ STYLE 4	+ 4.0	+ 1	HORIZ	= PEN 4
DATA-2					PENS	
TRACE 1	= PEN 3	+ STYLE 7	+ 4.0	+ 1	PEN WIDTH	= 0.30 mm
TRACE 2	= PEN 3	+ STYLE 6	+ 4.0	+ 1	PEN COUNT	= 8
TRACE 3	= PEN 3	+ STYLE 5	+ 4.0	+ 1	PEN SPEED	= 40 cm/s
TRACE 4	= PEN 3	+ STYLE 4	+ 4.0	+ 1	INFORMATION	
GRID					STYLE 0	.
HORIZ	= PEN 1	+ STYLE 7	+ 4.0	+ 1	STYLE 1	. .
DATA-1	= PEN 1	+ STYLE 7	+ 4.0	+ 1	STYLE 2	_____
DATA-2	= PEN 1	+ STYLE 7	+ 4.0	+ 1	STYLE 3	_____
LIMITS	= PEN 4	+ STYLE 7	+ 4.0	+ 1	STYLE 4	_____ . _____ .
BOX	= PEN 4	+ STYLE 7	+ 4.0	+ 1	STYLE 5	_____ - _____ -
					STYLE 6	_____ - - - _____ - -
					STYLE 7	_____

Printing speed of the pen.

To change setting, use digit keys.
To return to menu, press the Esc key.

Figure 15-5 Attributes Panel, PLOT.EXE

EJECT permits control of whether an HP LaserJet III or LaserJet II equipped with "Plotter in a Cartridge" ejects the sheet after the first plot or retains it for further plots. Different graphs may then be plotted onto the different positions on the paper by loading different .GDL files, selecting different plot positions, and plotting. Each graph will be stored in the plotter memory until the final graph is transmitted with EJECT set to ON; the plotter will then print. EJECT has no effect when .GL files are written which will later be used by the "Laser Plotter" software.

With an HPGL plotter, the paper may simply be left on the plotter through multiple operations of PLOT. The only effect of EJECT OFF with a plotter is to leave the pen uncapped at the end of a plot, though many plotters will automatically cap the pen when no commands are received for approximately 15 seconds.

The CALCULATED POSITION fields display the exact plot location resulting from the choices made in all the fields above. The CALCULATED POSITION fields also permit selection of any specific size and aspect ratio for a plot or print. P1 and P2 are the x and y coordinates of the corners of the plot. The units are plotter-dependent units and must be obtained from information furnished by the manufacturer of the particular plotter or laser printer. ***Any entry into any of the CALCULATED POSITION fields over-rides the selections of the PLOTS ON PAGE, SCALE SIZE, and PLOT POSITION fields above.*** When any entry is made into one of the CALCULATED POSITION fields, the message "User Position" appears above these fields. To cancel the CALCULATED POSITION entry and return to a choice among the standard pre-selections, move the cursor up to any of the fields above, select an item, and press the <Enter> key.

15.3.1.3. Attributes Panel

From the command menu of PLOT (obtainable via the <Esc> key), selecting ATTRIBUTES displays a screen similar to Figure 15-5. This screen permits selection of the appearance of the various lines, numbers, and text which make up the plot.

The DATA-1 and DATA-2 areas control the appearance of the one or two lines on the graph which plot the DATA-1 and DATA-2 values. GRID refers to the rectangular logarithmic or linear calibration grid onto which the data is plotted. LIMITS defines how any upper and/or lower comparison files will appear, if they were displayed by the <Alt><F7> keystroke before the graphic data was saved to the .GDL file. BOX defines the appearance of the outside rectangular lines around the entire graphic and text area.

In all these areas, the four controllable parameters of the line are plotter pen number (PEN #), type of line such as solid, dashes, dots, etc. (STYLE #), how frequently the dash or dot cycle repeats across the graph (SIZE %), and line width (WIDE). In the TEXT area, only pen number is selectable. Different pens may be specified to write the GENERAL information (graph title, test name, date and time), the DATA-1 parameter and units, DATA-2 parameter and units, and the numbers calibrating the horizontal axis of the graph (HORIZ).

Most plotters have carousel or other pen holders so that more than one pen can be in place at a time, selected by the plotter upon software request. Pens are available with many different ink colors plus writing technology choices (felt tip, ballpoint, Rapidograph, etc.). The total number of pens used to make a graph can be larger than the number of pens which the plotter holds at one time. When more pens are specified than are entered in the PEN COUNT field, PLOT.EXE will first draw the portions corresponding to the number of pens in place, then prompt the operator to replace pens and continue the plot. It is thus possible to make a plot with as many as 17 colors even on a single-pen plotter.

Under the DATA-1 and DATA-2 headings, line appearance may be independently specified for up to four TRACE values. The TRACE parameter refers to the multiple lines on a graph obtainable via a nested sweep (SOURCE-2 instead of DATA-2 on the SWEEP DEFINITION panel), use of the <Ctrl><F9> key to make additional tests without erasing the data from earlier tests, or after use of the APPEND TEST or APPEND DATA command to

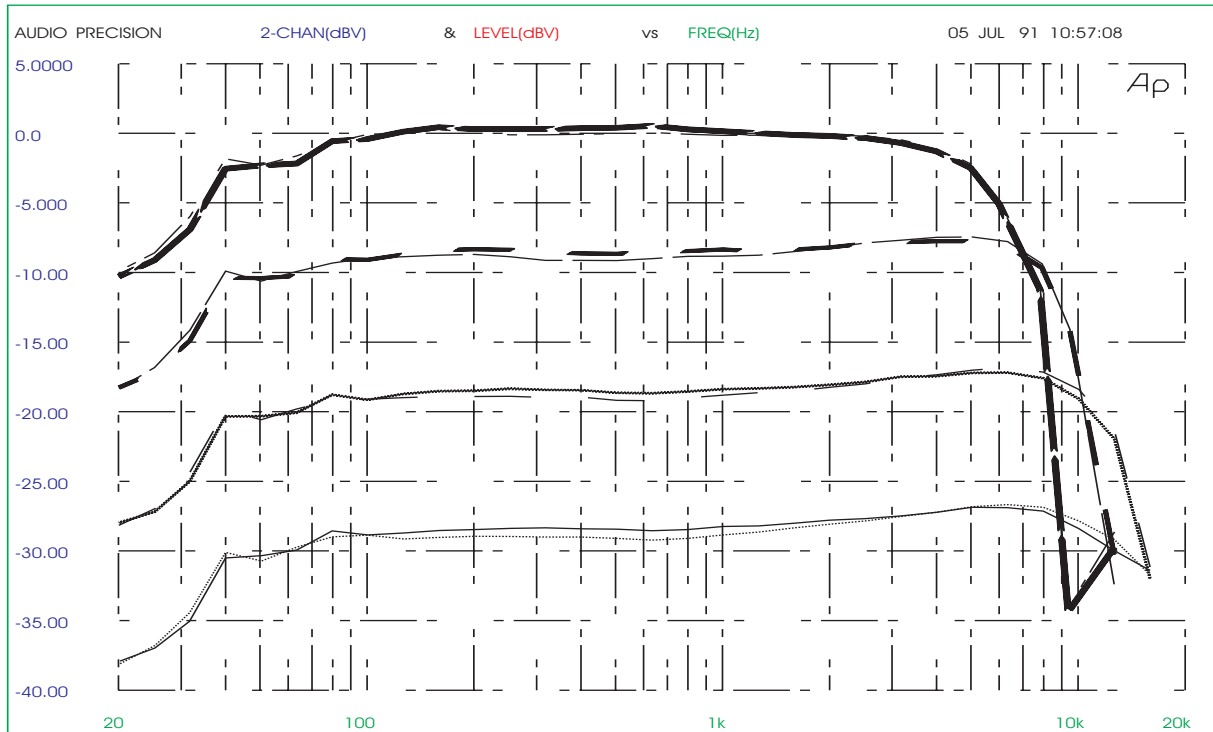

Figure 15-6 PLOT.EXE Print-Out of Nested Sweep of Cassette Recorder Response at Four Amplitudes. Differing Widths of Solid Line Used for DATA-1 Four Sweeps, Various Dot-Dash Patterns Used for DATA-2 Four Sweeps

bring multiple data sets into one file. The first four such traces for DATA-1 and DATA-2 may thus each be shown with a different line appearance. If the graph being plotted has five or more sweeps, the pen-vs-trace cycle will be repeated. For example, the fifth trace will use the TRACE 1 selection, the sixth will use TRACE 2, etc.

The STYLE # choices are illustrated in the INFORMATION block at the lower right of the ATTRIBUTES screen. For all selections other than the solid line (STYLE 7) and dots at each data point (STYLE 0), the SIZE % field adds control of how often the dash-dot cycle repeats along the graph. The scale reference for the % value is a diagonal line from corner to corner of the graph. For example, if 4% is entered, the dash-dot cycle length is 4% (1/25) of the diagonal dimension of the graph and would thus repeat 25 times on a data plot from corner to corner of the graph.

The WIDE field and PEN WIDTH fields permit control of the plotted line width. A WIDE value of 1 results in a single pen trace. Larger values for WIDE will produce repeated plots with the pen position offset by one pen width to produce a wider line. The WIDE value used is always an integer and will round to the nearest integer if a fraction is entered. If a trace wider than one pen width but narrower than two pen widths is desired, enter 2 as WIDE and enter a smaller value into the PEN WIDTH field than the actual pen tip width. The software then produces a smaller offset for the repeat plot.

If a striped line appearance is desired, with white areas between the repeated plots, enter a value of 2 or greater in the WIDE field and a larger value into PEN WIDTH than the actual pen tip width.

Figure 15-6 is an illustration of some of the line appearances possible through use of the Attributes panel of PLOT.EXE. This illustration was saved to disk as a .GL file and imported directly to Xerox Ventura Publisher as an HPGL file. Since it was to

be finally printed on a 300 dpi laser printer, pen width was set as 0.085 mm (25.4 mm/inch divided by 300 dots/inch). The four DATA-1 traces are all solid lines (Style 7) with WIDE values of 13, 9, 5, and 1. The four DATA-2 traces all use a WIDE value of 1, with Style 1 (dots), Style 2 (dashes), Style 4 (dot-dash), and Style 6 (long dash and two short dashes) used for the four traces.

15.3.1.4. HP LaserJet Printer Line Attributes

When the HP LaserJet II printer is used, the ultimate line appearance depends upon whether the "Plotter in a Cartridge" hardware adapter or the "Laser Plotter" software is being used. The LaserJet with "Plotter in a Cartridge" installed effectively becomes a single-pen plotter. The PEN # selection is thus effectively ignored. The STYLE #, SIZE %, and WIDE attributes function similarly to plotter usage. For WIDE to be properly used, and assuming the A/A4 paper size selection on the POSITION screen, the PEN WIDTH value must be entered as the width of one pixel on the laser printer which is essentially 0.085 mm (300 dots per inch resolution).

With "Laser Plotter" software, an additional step in the process permits the user to define gray level attributes corresponding to the PEN # selections made in PLOT.EXE. Control of the PEN #-to-gray level correspondence is described in the documentation furnished by the manufacturer of the "Laser Plotter" software. Note that "Plotter in a Cartridge" is approximately five times faster than "Laser Plotter".

15.3.1.5. Saving Configurations

When a complete selection has been made of all the POSITION screen and ATTRIBUTES screen choices, the results can be saved to disk in a configuration file format (.CFP) for later use. The SAVE CONFIGURATION command is used and any desired filename acceptable to DOS furnished. The .CFP extension is automatically supplied by the software. At any later time, the LOAD CONFIGURATION command may then be used to retrieve the complete configuration.

15.3.1.6. Making the Plot

When all the ATTRIBUTES and POSITION values have been entered, the LOAD GRAPHICS command may be used to load the .GDL file containing the data and text to be plotted. The plot is then made to a plotter or LaserJet with "Plotter in a Cartridge" installed by either the OUTPUT or SAVE OUTPUT commands. Either command gives a choice of computer output ports to which the plotter or laser printer is connected. Selecting the appropriate port (for example, COM1:) causes the information to be transmitted to the plotter or printer and the plot or print to begin. HPGL plotters are normally RS-232 interface devices and must be connected to COM1: or COM2:. The HP LaserJet III or the LaserJet II equipped with Plotter in a Cartridge may be used with either the parallel or RS-232 interface and will be faster from the parallel interface. With the LaserJet III, remember that PLOT must have been started with the /3 option as discussed earlier.

RS-232-connected devices normally use one of two methods to manage the transmission of data and avoid overflow of the data buffer in the device. One method is a hardware handshake wire in the interface cable. The alternate method is a form of software handshake called Flow Control or XON-XOFF protocol. The LaserJet with Plotter in a Cartridge may be set to either handshake mode via soft switches, described in the LaserJet manual. HPGL plotters normally use hardware handshake. PLOT.EXE may be configured at start-up for either technique via the /X command line option. If PLOT is started with no /X option or with the /X0 option, it is configured for hardware handshake as appropriate for typical HPGL plotters. If PLOT is started with the /X1 option, it is set for XON-XOFF protocol (flow control).

For output to a LaserJet printer via the "Laser Plotter" software, an additional step must be performed as described on page 15-16 below.

15.3.1.7. Color Separations

Selecting PEN # 0 results in no plotting or printing of the selected parameter. Original art for color separations can be prepared by multiple operations of PLOT, specifying PEN # 0 for all parameters except the ones desired for the present color. The BOX may be allowed to print in all separations, to use as an alignment aid.

15.3.1.8. Define Now, Print Later

It is possible to save complete plot information to disk for later plotting or printing. To save the information, supply a file name instead of selecting a computer port under the OUTPUT or SAVE OUTPUT commands. The software will automatically furnish the .GL extension. Then, at a later time, you may use the DOS COPY command with the file name and computer port specification to make a plot or print. If the file will be copied to a HP LaserJet III, remember to use the "/3" option in starting PLOT before saving the .GL file. Saved .GL files may be copied to a parallel-connected HP LaserJet III or LaserJet II with "Plotter In A Cartridge" installed, or to an RS-232-connected HPGL plotter. For example, if the file name furnished when the .GL file was saved was FREQRESP, then a plot could be made at a later time to an HPGL plotter by typing at the DOS prompt:

```
COPY FREQRESP.GL COM1: <Enter>
```

if the plotter is connected to the COM1 port. Note that the "P" option of the DOS MODE command must be invoked for the COPY command to function reliably. A typical MODE command, typed at the DOS prompt, would be:

```
MODE COM1:9600,N,8,1,P
```

The P instructs the computer to retry sending blocks of data when the plotter reports back that its input buffer is (temporarily) full.

PLOT.EXE software need not be present at the time of plotting in this mode. When this "save now and plot later" mode of operation is planned, the pen numbers specified on the ATTRIBUTES page

should not exceed the number which will be in place when the .GL file is later copied to the plotter. This is because there will be no pause and prompting message to the operator to change pens when the COPY command is given. Any subsequent software commands to change to higher-numbered pens will be ignored, resulting in the last pen being used to draw all remaining elements of the graph.

15.3.1.9. Batch Mode Operation

To incorporate plotting to an HPGL device or printing to an HP LaserJet automatically during a procedure, PLOT can also be run in a batch mode with two file names, an output port or output file name specification, one or more codes as command line options, and (for the HP LaserJet III only) the name of a comments or text file to be printed below the graph. One file name is the configuration file (.CFP) which specifies plot size, location, pen selection, line style, etc. Another file name specifies the .GDL file containing the data to be plotted. The output port specifies where the printer is connected, or an output file name will cause the graphics output to be saved to a file of that name with the .GL extension. The /O code is required for immediate output rather than entering interactive mode. For example, a System One procedure could contain the line:

```
DOS PLOT //O FULLPAGE THD-FREQ  
COM1: <Enter>
```

where DOS is System One's menu command to exit to DOS and execute one DOS-compatible command or program. PLOT is the program. /O is the command to output immediately, rather than merely loading the specified files and entering interactive mode. Note that the actual procedure listing must contain a double slash (//O) in order to function properly, since the S1.EXE Procedure Editor interprets single slashes as computer keyboard codes. If you create the procedure in Util Learn mode, the additional slash will be inserted automatically. If you create the procedure by typing directly into the Procedure Editor, remember to use two slashes whenever a single slash is to be passed to a DOS command.

FULLPAGE is an example name of a .CFP configuration file which completely specifies the size and location, pen choices, etc. This file would have been created in interactive use of the PLOT program by making all selections, then using the SAVE CONFIGURATION command of PLOT.EXE and supplying the file name. THD-FREQ is an example name of a .GDL file. This would have been created by the SAVE GRAPHICS command of S1.EXE following the running of a test. S1.EXE must have been started with the /G command line option in order for the SAVE GRAPHICS command to function. COM1: specifies that the plotter or laser printer is connected to serial port number one. Spaces are required between the word PLOT and the first element and between all elements. Order of the various elements is not important as long as the current directory does not contain .GDL, .CFL, or .GL files with the same names. If files of the same name do exist, the entire file name including extension should be explicitly typed.

The entire sequence in a procedure might then look like this:

```
LOAD TEST testfilename /R
/F9/E
SAVE GRAPHICS graphicsfilename/R
DOS PLOT //O configfilename graphicsfilename outputport/R
LOAD TEST etc.
```

The procedure listing must contain a double slash (//O) before any DOS "/" command line options in order to function properly, since the S1.EXE Procedure Editor interprets single slashes as computer keyboard codes. If you create the procedure in Util Learn mode, the additional slash will be inserted automatically. If you create the procedure by typing directly into the Procedure Editor, remember to use two slashes whenever a single slash is to be passed to a DOS command. Note also that S1.EXE must have been loaded with an appropriate /R or /B option to set aside enough memory for PLOT.EXE to operate; see the memory requirements discussion above.

When multiple plots are to be made onto a single sheet of paper in a LaserJet III or LaserJet II printer with Plotter in a Cartridge installed, two further com-

mand line options are useful in batch mode operation. The /E# option controls whether the page will be ejected following transmission of data to the laser printer. The /P# option controls at which position on the page the graph will be printed.

Use of the /E and /P options assumes that a configuration file (.CFP) specifying multiple plots on the page has been saved from earlier interactive operation of PLOT.EXE. The /P option may have any numeric value from 0 through 8, corresponding to positions 0 through 8 of the PLOT POSITION field of the POSITION panel of PLOT.EXE during interactive operation. The /E0 (zero) option is equivalent to EJECT OFF on the POSITION panel and causes the page to be retained in the laser printer. /E1 or /E with no number is equivalent to EJECT ON and causes the page to be ejected immediately after data transmission and printing.

As an example of usage of these options, assume that PLOT.EXE has been run to develop a configuration file, FOURPLOT.CFP, which specifies four plots on a page. The configuration file would also specify the desired line styles and text attributes on the ATTRIBUTES panel. Next, assume that S1.EXE has generated four .GDL files (XX, YY, ZZ, and AA) from four tests.

Now, the following sequence can be executed in a DOS batch file or procedure to generate four plots on one page:

```
PLOT FOURPLOT.CFP XX.GDL COM1: /O /E0 /P0
PLOT FOURPLOT.CFP YY.GDL COM1: /O /E0 /P1
PLOT FOURPLOT.CFP ZZ.GDL COM1: /O /E0 /P2
PLOT FOURPLOT.CFP AA.GDL COM1: /O /E1 /P3
```

In an S1.EXE procedure, the menu command DOS would be required at the start of each line, the file extensions (.CFP, .GDL) would not be needed unless duplicate names exist, and a /R code for <Enter> would be required at the end of each line. Note that only one configuration file is now needed.

15.3.1.10. Printing Comments to HP LaserJet III

Unlike the screen dump print mode initiated by the <*> key, contents of the comments editor are not printed via PLOT. However, a similar function can be obtained when the HP LaserJet III is used in batch mode (not interactive) printing. The text desired for printing beneath the graph can be prepared in Edit Comments mode or via any ASCII text editor and saved to disk. If another editor is used, supply the .TXT file extension which the Save Comments command automatically furnishes. Then, simply include this file name, separated by a space from other command line options or file names, following the PLOT command. For example, the DOS command:

```
PLOT /3 /O CONFIGFILE.CFP
GRAPHICSFILE.GDL TEXTFILE.TXT LPT1
```

will result in PLOT loading with the “/3” option required for the LaserJet III, going into immediate output rather than interactive mode, using CONFIGFILE to determine position and attributes settings, taking GRAPHICSFILE as the vector file input and sending it to the printer, sending TEXTFILE to the printer, and then ejecting the page with the text printed directly below the graph. The ATTRIBUTES screen of PLOT must be used when preparing and saving CONFIGFILE to set a graph size which will allow the required size text file to be printed below it on a single sheet of paper.

15.3.1.11. LaserJet Output via “Laser Plotter”

To drive an HP LaserJet via “Laser Plotter” software, a .GL file must first be saved as described above. PEN # selections should be made on the PLOT.EXE ATTRIBUTES panel where different appearance is desired, just as they would be for a plot-

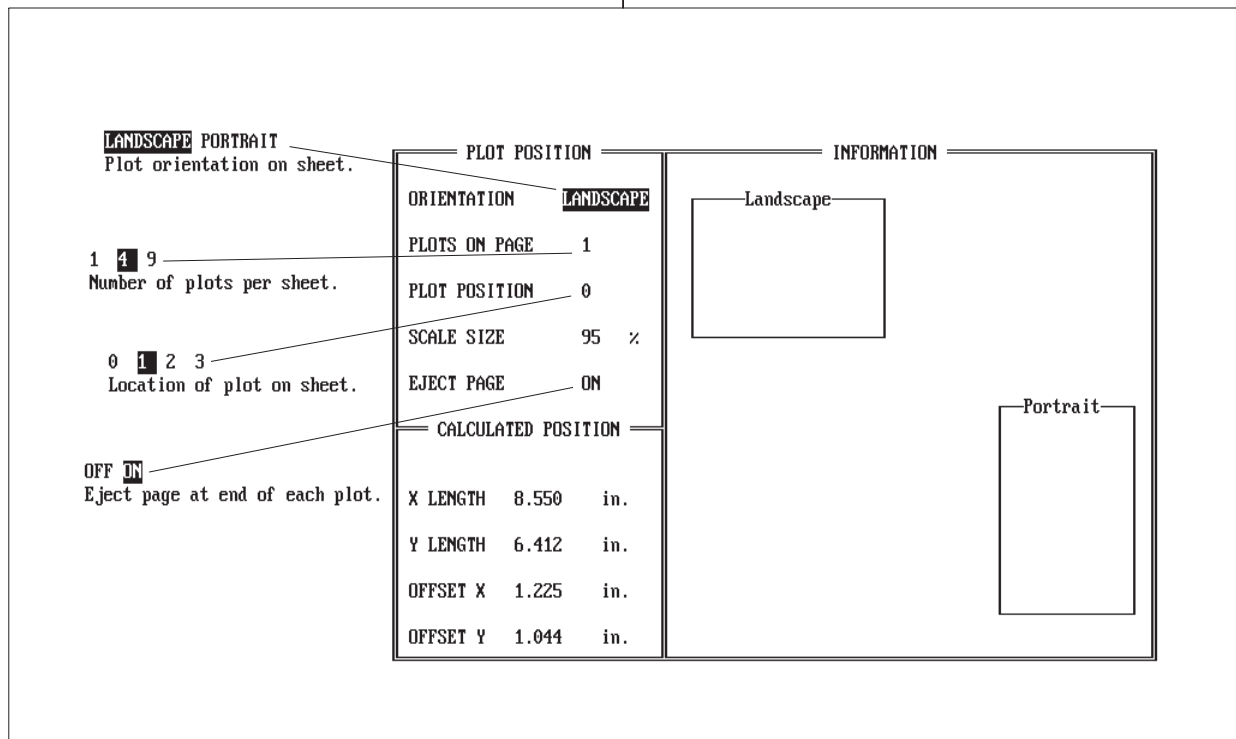

Figure 15-7 Position Panel, POST.EXE

LIFESTYLE					TEXT	
	GRAY	ON	OFF	WIDTH	STYLE	GRAY
DATA-1					TEXT	
TRACE 1 =	1.00	+ 0	+ 0	+ 100	GENERAL =	HelvetBold 1.00
TRACE 2 =	1.00	+ 0	+ 0	+ 100	DATA-1 =	TimesRoman 1.00
TRACE 3 =	1.00	+ 0	+ 0	+ 100	DATA-2 =	TimesRoman 1.00
TRACE 4 =	1.00	+ 0	+ 0	+ 100	HORIZ =	TimesBldItal 1.00
DATA-2					INFORMATION	
TRACE 1 =	1.00	+ 300	+ 75	+ 100	GRAY	1.00 is BLACK. 0.00 is WHITE.
TRACE 2 =	1.00	+ 0	+ 0	+ 100	ON	Length of respective
TRACE 3 =	1.00	+ 0	+ 0	+ 100	OFF	dash in user units. 0 ON, 0 OFF = solid.
TRACE 4 =	1.00	+ 0	+ 0	+ 100	WIDE	Width in user units 1 user unit = 1/32000 of X dim. of graph.
GRID					STYLE	
HORIZ =	1.00	+ 0	+ 0	+ 20	Font used for text.	
DATA-1 =	1.00	+ 0	+ 0	+ 20		
DATA-2 =	1.00	+ 0	+ 0	+ 20		
LIMITS =	1.00	+ 0	+ 0	+ 100		
BOX =	0.50	+ 0	+ 0	+ 200		

Gray scale to print data-1 trace 1. To change setting, use digit keys.
To return to menu, press the Esc key.

Figure 15-8 Attributes Panel, POST.EXE

ter. After saving the .GL file, QUIT from PLOT.EXE and load the "Laser Plotter" software from the DOS prompt by typing:

LP <Enter>

The "Laser Plotter" software, assisted by documentation furnished by the manufacturer, then permits selection of the gray levels and other attributes which will correspond to the PEN # selections made during PLOT.EXE operation. Finally, the actual printout will be initiated from the "Laser Plotter" software. Laser Plotter software can communicate with the HP LaserJet via either the parallel interface or RS-232 (serial) interface.

Note that "Plotter in a Cartridge" is much faster, producing LaserJet output in about 45 seconds for a typical graph while "Laser Plotter" may require over five minutes.

15.3.2. PostScript Laser Printer Output

POST.EXE is a program furnished for use with the Apple LaserWriter and other PostScript-compatible laser printers. POST is started from the DOS prompt simply by typing:

POST <Enter>

POST is normally able to determine the type of display system in the computer and configure itself accordingly. If the automatic configuration does not work properly, the /D option may be used at startup to force selection of a particular display mode. For example, to force configuration for a Hercules monochrome display system the /D1 option is required and the software would be started with the command:

POST /D1 <Enter>

See the Graphic System Compatibility section beginning on page 5-7 for full details.

POST can be run after quitting S1.EXE software. POST may also be run during an XDOS or DOS temporary exit from S1.EXE. In this case, S1.EXE must have been started with the /R, /B, or /&filename options so as to leave sufficient memory available to DOS for operation of the program. The POST program itself occupies about 100 kbytes of memory, plus an additional amount which depends upon the complexity of the image to be plotted. This additional amount may be estimated by assuming 3 kbytes for the empty grid plus text and 16 bytes per data vector. For example, a 100-step graph with both DATA-1 and DATA-2 in use would have 100 vectors per data value or 200 vectors total, requiring 3200 bytes. The total memory requirement in this case would be 100 kbytes for the program, 3 kbytes for the blank grid, and 3.2 kbytes for data vectors for a total of about 106 kbytes. A common large memory requirement is likely to occur when plotting FFTs which may have as many as 500 points to plot (8 kbytes for the data). Nested sweeps or appended tests with many lines on the graph may also have large memory requirements. See the CREATING YOUR CUSTOM SOFTWARE START-UP PROCESS Chapter starting on page 28-1 for more information on the /R, /B, or /&filename options.

Note also that your disk, in the current directory, must have space available for temporary files created during the operation of POST.EXE. This temporary file (APTEMP\$.PS) will be approximately four times the size of the input .GDL file which POST is using.

When POST loads, an introductory screen will display along with the menu choices across the bottom as follows:

```
CMD: POSITION ATTRIBUTES OUTPUT
SAVE LOAD QUIT
```

This menu operates similarly to S1.EXE's command menu. The <Space> bar, horizontal arrow keys, or mouse may be used to move the cursor to the desired selection and the <Enter> key used to

make the selection. Alternately, a selection may be made by pressing the key corresponding to the first character of the command. Returning to this menu from any screen within POST is accomplished by the <Esc> key.

15.3.2.1. Position Panel

When POSITION is selected, a screen similar to Figure 15-7 will be displayed. The arrow keys or mouse may be used to move a cursor onto each field which can be changed. Some fields are multiple choice, while others accept numeric entry from the keyboard.

ORIENTATION permits selection of the orientation of the graph with respect to the paper. In PORTRAIT mode, the paper must be held with its long axis vertical for the graph to be normally viewed. In LANDSCAPE mode, the graph will be normally viewed with the paper's long axis horizontal.

PLOTS ON PAGE permits selection of a single or multiple plots on a page. Normally, each plot would be a different graph. The number of plots and relative orientation of the plots depends upon whether landscape or portrait mode has been selected. The alternatives are clearly illustrated in the right portion of the screen.

PLOT POSITION selects which of the multiple positions a graph will be printed onto during the current printing session. If only one plot per page has been selected, only the 0 selection is available. With a multiple plot selection, the right side of the screen illustrates the position numbering scheme.

SCALE SIZE selects the size of the graph print. The aspect ratio (horizontal-to-vertical size ratio) will be 4:3 for any scale size entered. The default selection is 95% to create some white space between multiple plots on the same page, but any numeric value may be entered. The scale size value may be superseded by making specific entries into the CALCULATED POSITION fields below.

The EJECT field permits control over whether the paper is ejected after the current plot, or remains in the printer for additional plots. Setting EJECT

OFF for all but the final graph of multiple plots on a page thus permits loading and printing several .GDL files onto different positions on the page. Each of the plots transmitted from POST.EXE is stored in the laser printer memory until the EJECT ON command is sent. The sheet then prints with multiple graphs.

The CALCULATED POSITION fields display the size and offset location of the particular plot selected by the fields above. The units for these fields may be selected as inches or centimeters. Alternately, numeric entry can be made into these fields to permit selection of any specific size, aspect ratio, and location for a print. **When any entry is made, the message "User Position" appears above the entries and the user entries over-ride the selections made in the PLOT POSITION and PLOTS ON PAGE fields above.** To return to the mode of selecting among the standard pre-selections, move the cursor up to any of the fields in the PLOT POSITION section (ORIENTATION, PLOTS ON PAGE, or PLOT POSITION) and press the <Enter> key to cancel any user-made entries into the CALCULATED POSITION fields.

15.3.2.2. Attributes Panel

From the command menu of POST (obtainable via the <Esc> key), selecting ATTRIBUTES displays a screen similar to Figure 15-8. This screen permits selection of the appearance of the various lines, numbers, and text which make up the graph.

The DATA-1 and DATA-2 areas control the appearance of the one or two lines on the graph which plot the DATA-1 and DATA-2 values. GRID refers to the logarithmic or linear calibration grid onto which the data is plotted. LIMITS defines how any upper and/or lower comparison files will appear, if they were displayed by the <Alt><F7> keystroke before the graphic data was saved to the .GDL file. BOX defines the appearance of the outside rectangular lines around the entire graphic and text area.

In all these areas, the four controllable parameters of the line are density or gray level (GRAY), length of dashes (ON), length of space between dashes (OFF), and line width (WIDE).

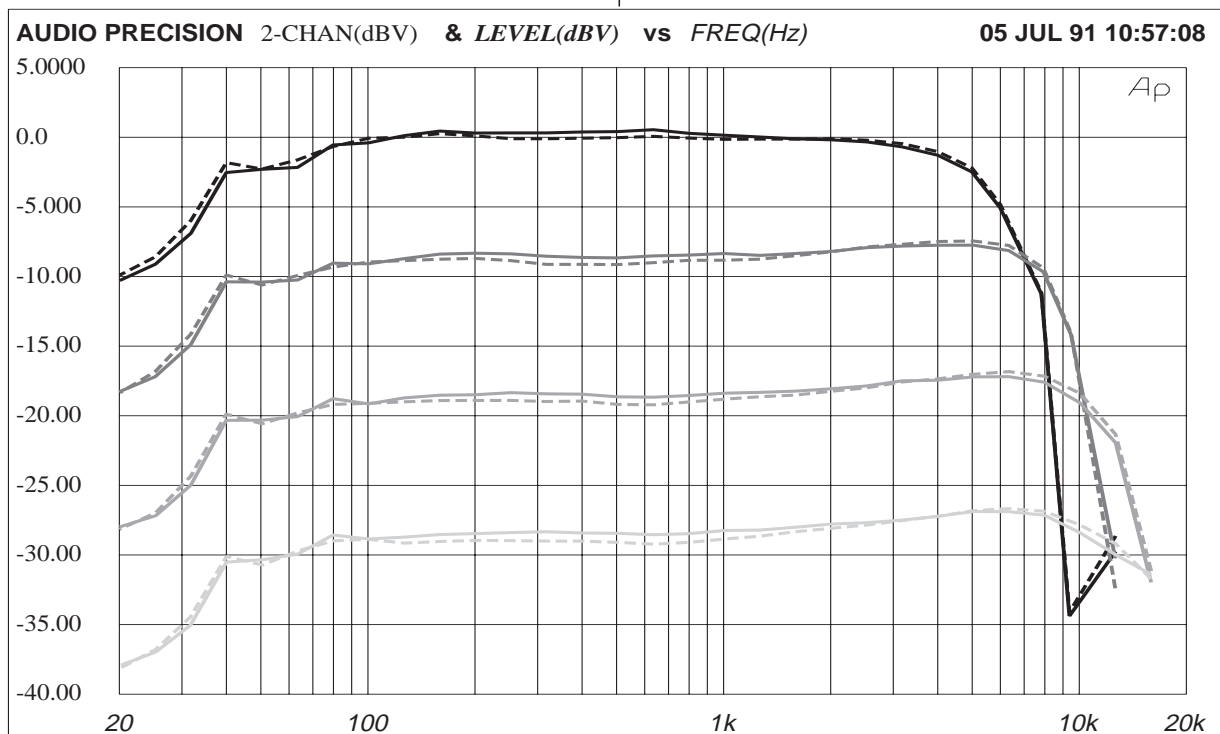

Figure 15-9 POST.EXE Print-Out of Nested Sweep of Cassette Recorder Response at Four Amplitudes. Differing Gray Densities of Solid Line Used for DATA-1 Four Sweeps, Differing Density Dash Patterns Used for DATA-2 Four Sweeps

In the TEXT area, the type font style (STYLE) and gray level (GRAY) are selectable. The STYLE choices include the Helvetica (a sans-serif font sometimes called Swiss) and Times Roman (with serifs) fonts in normal, bold, italic, and bold italic styles. Different fonts and gray levels may be specified to write the GENERAL information (graph title, test name, date and time), the DATA-1 parameter and units, DATA-2 parameter and units, and the numbers calibrating the horizontal axis of the graph (HORIZ).

Under DATA-1 and DATA-2 headings, the line appearance may be independently specified for up to four TRACE values. The TRACE parameter refers to the multiple data sets obtainable via a nested sweep (SOURCE-2 instead of DATA-2), use of the <Ctrl><F9> key to make additional tests without erasing the data from the first test, or after use of the APPEND TEST or APPEND DATA command to bring multiple data sets into one file. The first four such traces for either DATA-1 or DATA-2 may thus each be shown with a different line appearance. If the graph being plotted had five or more sweeps, the attribute-vs-trace cycle will be repeated. For example, the fifth trace will use the TRACE 1 selection, the sixth will use TRACE 2, etc.

The ON, OFF, and WIDTH values are all stated in "user units", where one unit equals 1/32000 of the X (horizontal) dimension of the graph as selected on the POSITION panel.

Figure 15-9 is an illustration made from the same .GDL file used for Figure 15-6 earlier in this chapter, to demonstrate some of the attributes of POST.EXE. Gray densities of 1.00, 0.60, 0.40, and 0.20 were used for the four traces of both DATA-1 and DATA-2. Solid lines were used for DATA-1 and dashed lines at 300 units ON, 150 units OFF were used for DATA-2. The text fonts were Helvetica Bold for AUDIO PRECISION and the date and time, Helvetica Italic for FREQ(Hz), Times Roman for 2-CHAN(dBV), and Times Roman Bold Italic for & LEVEL(dBV). This illustration was saved as a disk file using the /I option of POST.EXE which creates an Encapsulated Postscript file (.EPS). See the Desktop Publishing section below for more details.

15.3.2.3. Saving Configurations

When a complete selection has been made of all the POSITION screen and ATTRIBUTES screen choices, the results can be saved to disk in a configuration file format (.CFL) for later use. The SAVE CONFIGURATION command is used and any desired filename acceptable to DOS furnished. The .CFL extension is automatically supplied by the software. At any later time, the LOAD CONFIGURATION command may then be used to retrieve the complete configuration.

15.3.2.4. Making the Printout

When all the ATTRIBUTES and POSITION values have been entered, the LOAD GRAPHICS command may be used to load the .GDL file containing the data and text to be plotted. The plot is then made by either the OUTPUT or SAVE OUTPUT commands. Either command gives a choice of computer output ports to which the laser printer is connected. Selecting the appropriate port (for example, COM1:) causes the information to be transmitted to the printer and the print to begin. The Apple LaserWriter has no parallel interface and must be connected to COM1: or COM2:. RS-232-connected devices normally use one of two methods to manage the transmission of data and avoid overflow of the data buffer in the device. One method is a hardware handshake wire in the interface cable. The alternate method, used by the Apple LaserWriter, is a form of software handshake called Flow Control or XON-XOFF. POST.EXE may be configured at start-up for either technique via the /X command line option. If POST is started with no /X option or with the /X1 option, it is configured for the XON-XOFF protocol (flow control) as required by the Apple LaserWriter. If POST is started with the /X0 option, it is set for hardware handshake.

15.3.2.5. Color Separations

A GRAY value of 0.00 results in no printing of the selected parameter. Color separations can be prepared by multiple operations of POST.EXE, specifying GRAY 0.00 for all parameters except those to

be printed in the current color. The BOX may be allowed to print in all separations, to use as alignment marks.

15.3.2.6. Saving to Disk

It is possible to save complete plot information to disk for later use. To save the information, supply a file name instead of selecting a computer port under the OUTPUT or SAVE OUTPUT commands. The software will automatically furnish the .PS extension (.PS for PostScript). Then, at a later time, this disk file may be used with appropriate software or hardware to produce output on a photo typesetter or laser printer.

15.3.2.7. Desktop Publishing

Some desktop publishing software, including Xerox Ventura Publisher (which is used to prepare this manual), can import Encapsulated Postscript files (.EPS extension). POST.EXE will save files in the .EPS format when POST is loaded with the /I option. For example

```
POST /I <Enter>
```

Note that Ventura Publisher cannot display the content of .EPS files on screen, but will only show the boundary of the graphic with a large "X" superimposed. The graphic will print correctly to a Postscript-compatible printer, however.

15.3.2.8. Batch Mode Operation

To incorporate printing to a PostScript-compatible laser printer automatically during a procedure, POST can also be run in a batch mode with two file names, an output port specification, and one or more codes as command line options. One file name is the configuration file (.CFL) which specifies plot size, location, gray level, line style, etc. Another file name specifies the .GDL file containing the data to be plotted. The output port description describes where the printer is connected; alternately, an output file name can be specified, into which the graphics data will be saved with a .PS extension. The /O

code is required for immediate output rather than entering interactive mode. For example, a System One procedure could contain the line:

```
DOS POST //O FULLPAGE THD-FREQ
COM1: <Enter>
```

where DOS is System One's menu command to exit to DOS and execute one DOS-compatible command or program. POST is the program. /O is the command to output immediately, rather than merely loading the specified files and entering interactive mode. Note that the actual procedure listing must contain a double slash (//O) in order to function properly. If you create the procedure in Util Learn mode, the additional slash will be inserted automatically. If you create the procedure by typing directly into the Procedure Editor, remember to use two slashes whenever a single slash is to be passed to a DOS command.

FULLPAGE is an example name of a .CFL configuration file (configuration, LaserWriter) which completely specifies the size and location, pen choices, etc. This file would have been created in interactive use of the POST program by making all selections, then using the SAVE CONFIGURATION command of POST.EXE and supplying the file name. THD-FREQ is an example name of a .GDL file. This would have been created by the SAVE GRAPHICS command of S1.EXE following the running of a test. S1.EXE must have been started with the /G command line option in order for the SAVE GRAPHICS command to function. COM1: says that the laser printer is connected to serial port number one (or, an output file name may be substituted). Spaces are required between the word POST and the first element and between all elements. Order of the various elements is not important as long as the current directory does not contain .GDL, .CFP, or .PS files with the same names. If files of the same name do exist, the entire file name including extension should be explicitly typed.

The entire sequence in a procedure might then look like this:

```
LOAD TEST testfilename /R
/F9/E
SAVE GRAPHICS graphicsfilename/R
```

```
DOS POST //O configfilename graphicsfile-
name outputport/R
LOAD TEST etc.
```

Note that S1.EXE must have been loaded with an appropriate /R or /B option to set aside enough memory for POST.EXE to operate; see the memory requirements discussion above.

When multiple plots are to be made onto a single sheet of paper, two further command line options are useful in batch mode operation. The /E# option controls whether the page will be ejected following transmission of data to the laser printer. The /P# option controls at which position on the page the graph will be printed.

Use of the /E and /P options assumes that a configuration file (.CFL) specifying multiple plots on the page has been saved from earlier interactive operation of POST.EXE. The /P option may have any numeric value from 0 through 8, corresponding to positions 0 through 8 of the PLOT POSITION field of the POSITION panel of POST.EXE during interactive operation. The /E0 (zero) option is equivalent to EJECT OFF on the POSITION panel and causes the page to be retained in the laser printer. /E1 or /E with no number is equivalent to EJECT ON and causes the page to be ejected immediately after data transmission and printing.

As an example of usage of these options, assume that POST.EXE has been run to develop a configuration file, FOURPLOT.CFL, which specifies four plots on a page. The configuration file would also specify the desired line styles and text attributes on the ATTRIBUTES panel. Next, assume that S1.EXE has generated four .GDL files (XX, YY, ZZ, and AA) from four tests.

Now, the following sequence can be executed in a DOS batch file or procedure to generate four plots on one page:

```
POST FOURPLOT.CFL XX.GDL COM1: /O /E0 /P0
POST FOURPLOT.CFL YY.GDL COM1: /O /E0 /P1
POST FOURPLOT.CFL ZZ.GDL COM1: /O /E0 /P2
POST FOURPLOT.CFL AA.GDL COM1: /O /E1 /P3
```

In an S1.EXE procedure, the menu command DOS would be required at the start of each line, the file extensions (.CFL, .GDL) would not be needed, and a /R code for <Enter> would be required at the end of each line. Note that only one configuration file is now needed.



16. INTERMODULATION DISTORTION

With the IMD-GEN and IMD-DIS options installed, System One can perform stimulus-response intermodulation distortion measurements by three different techniques: SMPTE/DIN, CCIF (twin-tone) difference tone, and DIM/TIM. The SMPTE (Society of Motion Picture and Television Engineers) is the oldest standard. The DIN (Deutsches Institut für Normalisierung) standard is similar to SMPTE. CCIF is believed to be the initials of a European organization since merged into another standards organization. The so-called CCIF method is also described as IHF-IM by the Institute of High Fidelity. DIM and TIM (Dynamic Intermodulation and Transient Intermodulation) testing methods are understood to be in the process of standardization by the IEC in Europe.

16.1. Theory of Operation

The SMPTE and DIN methods use a signal consisting of a low-frequency (LF) tone and a high-frequency (HF) tone, usually at an amplitude ratio of 4 to 1 (low frequency to high frequency). Non-linearity in the device under test will cause amplitude modulation of the high-frequency tone by the low frequency tone. The System One analyzer treats the high-frequency tone plus sidebands as an amplitude-modulated signal, applies it to an AM detector, measures the amplitude of the recovered sidebands, and expresses it relative to the amplitude of the high frequency “carrier” signal. The SMPTE standard specifies a 60 Hz LF tone in a 4:1 amplitude ratio with a 7 kHz HF tone. DIN allows several choices of tone frequency selection; 250 Hz and 8 kHz are the most popular.

System One also permits “SMPTE-like” tests with user-selected frequencies and amplitude ratios. The System One IMD generator provides seven choices for the LF tone, two choices of amplitude ratio, and allows the “HF” tone to be set anywhere within the range of the generator (which could thus be lower in frequency than the “LF” tone). The Sys-

tem One analyzer can accurately analyze SMPTE-like signals only when the high frequency tone is at 3.0 kHz or above. The applied amplitude ratios can vary from 0:1 (no low frequency tone present, thus measuring only incidental amplitude modulation of high frequency tone) to at least 8:1, with IMD products (sidebands) between 40 Hz and 500 Hz around high-frequency tones (carriers) between 3 kHz and 200 kHz. The 3 dB analysis bandwidth after the am detector is 30 Hz to 700 Hz; thus, if it is desired that the measurement be sensitive to both second and third order IM products, the generator IM frequency should not be set above 250 Hz so that the third order product will fall within the analysis band.

The CCIF or difference frequency method applies a stimulus of two closely-spaced equal amplitude tones to a device under test (DUT). Non-linearities in the DUT will result in a variety of IMD products. System One measures the amplitude of only the difference tone; the low-frequency product (second order) existing at a frequency equal to the spacing between the two stimulus tones. The System One generator provides seven choices of tone spacing; it then generates a pair of tones spaced symmetrically about the main generator carrier frequency; the main generator amplitude is suppressed. The System One IMD analyzer properly measures the amplitude of the difference tone produced when the frequency of the lower of the two-tone pair is between 4 kHz and 200 kHz, with tone spacing of 80 Hz to 1 kHz.

The DIM or TIM test method provided by System One combines a square wave at 3.15 kHz (DIM 100kBW or DIM 30kBW) or 2.96 kHz (DIM B) in a 4:1 pk-pk amplitude ratio with a sine wave “probe tone”. The IM-FREQ field on the generator panel is blanked during DIM testing. The square wave is bandwidth limited by a single-pole low-pass filter at either 100 kHz (100kBW) or 30 kHz (30 kBW and B). The probe tone may be generated at any frequency setting of the main generator. The analyzer measures the amplitude of any resulting products falling between 750 Hz and 2.4 kHz. A probe tone

of 15.0 kHz is recommended for the DIM30 or DIM100 tests, since this will produce a fifth-order (odd) product at 2.40 kHz ($15.0 \text{ kHz} / 4 * 3.15 \text{ kHz}$) and a sixth-order (even) product at 750 Hz ($5 * 3.15 \text{ kHz} / 15.0 \text{ kHz}$). The test thus produces a single measurement which has approximately equal sensitivity to odd and even order slewing nonlinearities. Similarly, a 14 kHz probe tone is recommended for the DIM-B test for the same reason. The DIM-B test has been recommended for FM radio and TV audio testing because of their 15 kHz bandwidth limitations.

16.2. Setting Up the Generator Panel

The software distribution diskette includes standard panel set-ups for SMPTE, DIN, CCIF, DIM 100, DIM 30, and DIM-B. These make good starting points for variations as desired. SMPT-FRQ.TST sets the generator to a 60 Hz IM-FREQ in a 4:1 amplitude ratio with a 7.000 kHz main generator FREQUENCY. DIN.TST is also a 4:1 amplitude ratio, but with 250 Hz as the IM-FREQ and 8.000 kHz as the high frequency. CCIF.TST selects a 13.50 kHz main generator frequency (suppressed). IM-FREQ indicates the spacing between tones in CCIF mode, which is 1.000 kHz for CCIF.TST, producing twin tones at 13 kHz and 14 kHz. DIM100.TST and DIM30.TST both select a 15.0 kHz probe tone, while DIM-B.TST uses a 14.00 kHz probe tone.

Amplitude calibration in all IMD waveforms is in sinewave peak equivalent terms; for example, selecting an AMPLITUDE of 1.000 Volt will result in the complex IMD signal having the same 2.828 Volt peak-to-peak amplitude that a 1.000 Volt sine wave has. Clipping in a device under test will thus occur at the same generator amplitude for THD+N and IMD modes.

In SMPTE (DIN) mode, the seven available choices for the low frequency tone are 40, 50, 60, 100, 125, 250, and 500 Hz. Selection may be made on an increment-decrement basis by using the <+> and keys while the cursor is placed on the IM-FREQ indication field. Alternately, a number may be entered into that field from the keyboard

with the digit keys. The software will select the choice nearest the entered frequency when the <Enter> key is pressed.

In CCIF mode, the spacing between the two generated tones may be selected in the same fashion from the choices of 80, 100, 120, 200, 250, 500, and 1000 Hz. These frequency spacing values are exactly twice the SMPTE frequencies listed above, since the same oscillator is used in a balanced modulator technique to generate the tone pair.

In DIM mode, the square wave frequency is fixed at either 3.15 kHz in DIM 30 and DIM 100 modes or at 2.96 kHz in DIM B mode. This frequency is not indicated on the generator panel, but will generally be measured and displayed by the analyzer frequency counter when the signal is fed to the analyzer module.

The main generator minimum useful frequency (suppressed center frequency) in CCIF mode is 4.0 kHz, since lower values would produce erroneous results; in fact, a 4.0 kHz center frequency and 1.0 kHz spacing in CCIF mode will produce somewhat degraded accuracy and residuals. Similarly, 4.0 kHz is the minimum useful main generator (probe tone) frequency in the DIM modes. In SMPTE mode, the analyzer residual SMPTE/DIN IMD will increase rapidly with main generator frequencies below approximately 3 kHz. The analyzer will not produce accurate measurements with main generator frequencies below 2.5 kHz. There are non-IMD applications, such as compander swept frequency response testing, for placing the main generator lower than 3 kHz, even below the IM-FREQ.

16.3. Setting Up the Analyzer Panel

Analyzer set-up for IMD testing is done principally by selecting the desired IMD mode. When an IMD mode is selected, the BW field near the center of the analyzer panel will indicate the approximate 3 dB analysis bandwidth of the instrument for specified accuracy. None of the absolute measurement units (V, dBm, dBu, dBV, dBr) can be selected in the IMD modes, even though they are available in THD+N mode. This is because SMPTE/DIN IMD

is inherently defined as a percentage of (or ratio to) the high frequency “carrier” tone; measurement of the distortion products in absolute units has no significance.

16.4. Bandpass Filter Use During IMD Testing

In most IMD testing, the BP/BR FREQ line will be left in the AUTO position. This will automatically tune the bandpass filter to the difference frequency tone in CCIF mode, and positions it as a band reject filter to assist stopband attenuation in the SMPTE and DIM modes. For certain applications in SMPTE and DIM testing, however, it is useful to fix the filter as a bandpass at certain frequencies for further information on the distortion products and to obtain lower residual noise contribution. It can also be very illuminating to sweep the bandpass filter in SMPTE-DIN modes to graph the IM products of several orders.

In SMPTE testing, the bandpass filter can be used to discriminate between the even and odd order products. Assuming the stimulus to include a 60 Hz signal as the f_1 tone, the BP/BR FREQ line can be changed from AUTO to 60 Hz; the reading will then consist essentially of the second order product (f_1 tone \pm f_1 tone). If the BP/BR FREQ is set to 120 Hz when the signal has a 60 Hz low frequency component, the reading will consist essentially of the third order product (f_1 tone \pm $2 * f_1$ tone).

If it is desired to graphically display all products within the 700 Hz analysis bandwidth of SMPTE-DIN mode, SOURCE-1 can be set for an analyzer BP/BR sweep from perhaps 1 kHz to 30 Hz. Figure 16-1 shows the result of such a test, using the 50 Hz-7 kHz signal from a test compact disc. The bandpass filter rejection is approximately 16 dB (original hardware) or 32 dB (A-version hardware) at half and twice its center frequency.

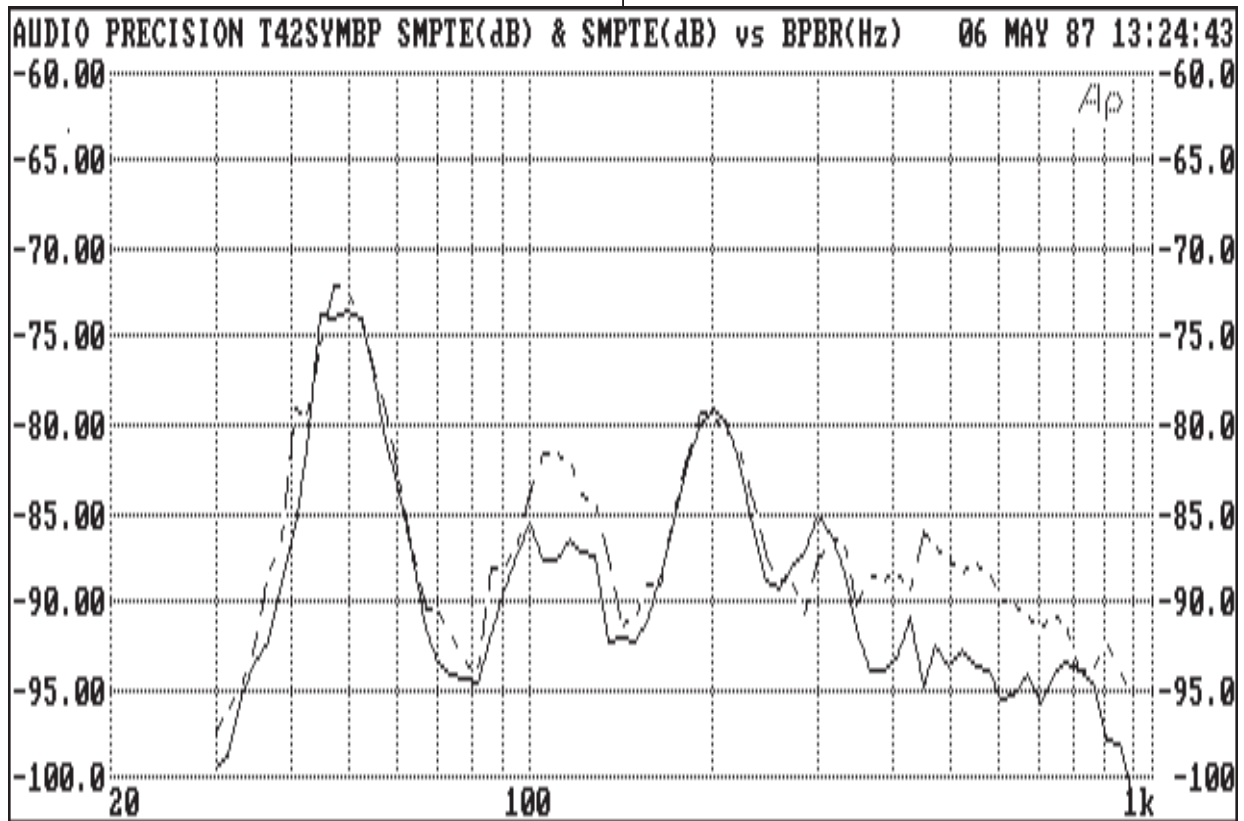

Figure 16-1 Spectral Analysis of SMPTE IMD Products

Similarly, the filter can be used in DIM testing to discriminate between the fifth order (odd) and sixth order (even) products. With the recommended 15.0 kHz probe tone in DIM100 and DIM30 tests, the BP/BR FREQ line can be set to 2.40 kHz to produce a reading of only the fifth order product, and to 750 Hz to measure only the sixth order product. For the DIM-B test with the recommended 14.00 kHz probe tone, the correct frequencies are 2.16 kHz for the fifth order product and 800 Hz for the sixth order.

16.5. Intermodulation Distortion Sweep Testing

All three forms of IMD can be usefully swept in amplitude, showing the distortion characteristics of a device across its entire dynamic range. The CCIF mode may be superior to THD+N tests at low amplitudes since it is much more narrow-band and therefore does not become noise limited until much lower amplitudes.

SMPTE and CCIF IMD tests can also be usefully performed as frequency sweeps. Sweeping the probe tone in DIM tests is of questionable utility, since only certain bands of probe tone frequencies will produce moderately low-order products which fall into the 750 Hz-2.4 kHz analysis band. SMPTE-like tests can have the high frequency tone swept from 2.5 kHz to any upper limit within range of the generator, though maximum accuracy and residual IMD performance is specified only when the high frequency tone is between 3 kHz and 20 kHz. CCIF tests can have the (suppressed) center frequency swept from 4.0 kHz to any upper frequency. Fully-specified performance is limited to lower-tone frequencies (main generator center FREQUENCY minus one-half the IM-FREQ spacing) above 4 kHz, with 20 kHz the upper limit for full accuracy.

16.6. Amplitude Measurements of IMD Signals

Since IMD signals consist of two or more tones, they are non-sinusoidal by definition. As noted earlier in this section, System One's generator ampli-

tude calibration for all IMD signals is in terms of sinewave peak equivalent amplitude. A generator amplitude selection of 1.000 Volts amplitude will thus produce an IMD waveform of 2.828 Volts peak-to-peak, the same peak-to-peak voltage which a 1.000 Volt rms sinewave has.

The equivalent measurement calibration in System One requires use of the S-Pk "detector" choice. S-Pk stands for scaled peak. S-Pk is not actually a separate detector circuit. S-Pk uses the Peak detector of System One, but multiplies the measurement by 0.707 before display. S-Pk thus displays the amplitude of a sinewave which would have the same peak-to-peak amplitude as the actual signal waveform being measured.

A typical example of use of the S-Pk detector might be after having adjusted the generator amplitude (perhaps in bargraph mode) for the threshold of a rapid increase in IMD distortion from a power amplifier. If the amplifier power at this point were then measured using the RMS detector, the result would differ markedly from a similar measurement using THD+N and would also differ significantly from the rated output power from the amplifier. Using the S-Pk detector will produce a measurement of the equivalent sinewave power, which should correlate well both with the manufacturer's power ratings and with similar measurements using sinewaves and THD+N.

17. WOW AND FLUTTER

17.1. Theory of Operation

Wow and flutter is the undesirable frequency modulation of an audio signal due to instantaneous speed variations caused by mechanical imperfections in a recording and playback mechanism such as a tape recorder or turntable. Wow and flutter measurements are usually made with a test tape or disk having a pre-recorded tone that is assumed to contain very little residual FM. The reproduced tone is bandpass filtered to limit potential wideband interference and is fed into an FM discriminator. The output of the discriminator is an ac signal whose amplitude is proportional to the instantaneous frequency deviation of the test tone. For most measurements this signal is passed, before detection, through a selectable weighting filter whose peak response is centered at about 4 Hz. The purpose of the weighting filter is to produce numerical results which parallel the human ear's sensitivity to different frequency components of wow and flutter. Unweighted measurements simply bypass the weighting filter.

17.2. Measurement Standards

Four major standards exist for the measurement of wow and flutter: IEC, DIN, NAB, and JIS. All recommend the measurement of weighted frequency modulation of a test tone, but differ in specific test tone frequency, detector type, and/or "ballistics" (the dynamic response of the detector). The IEC and DIN standards are identical and recommend a 3.15 kHz test tone with a quasi-peak detection characteristic. Both NAB and JIS recommend a 3.0 kHz test tone but differ in detector type: NAB specifies an average response (rms calibrated), JIS specifies "effective" response which is similar to NAB detection but with a much longer integration time constant.

The flat or unweighted bandwidth of the NAB and JIS recommendations extends from 0.5 Hz to 200 Hz, covering the portion of the spectrum where

frequency modulation is normally caused by imperfect rotating components such as idlers, wheels, capstans, pulleys, or motors. IEC/DIN recommends a 0.2 Hz lower cutoff; however, little energy is normally present below 0.5 Hz. Because the settling time of a practical 0.2 Hz system cutoff would be 5 to 10 seconds, the low frequency cutoff of the Audio Precision System One wow and flutter measurement option is designed to be 0.5 Hz regardless of the standard selection. Weighted measurements are not compromised because the weighting filter response includes the effects of the 0.5 Hz low frequency rolloff.

17.3. Scrape Flutter

Frequency modulation in tape recorders can also be caused by frictional effects of the tape sliding over guides or the tape heads themselves. This form of imperfection is called "scrape" flutter and is characterized by FM products extending to 5 kHz, but often peaking near 3 kHz. Motors with servo speed regulation can also exhibit FM products substantially above the 200 Hz cutoff of normal unweighted wow and flutter measurements. Higher frequency FM products are perceived more as added noise, "grit", or "harshness" instead of as frequency modulation.

To measure this form of flutter, it is necessary to use a higher test tone or "carrier" frequency to permit FM discrimination of products to 5 kHz without aliasing. To achieve this extended performance, System One utilizes the HIGH BAND flutter measurement technique developed by Dale Manquen of Altair Electronics, Inc. The recommended HIGH BAND test tone frequency of 12.5 kHz yields the desired measurement bandwidth of 5 kHz on recorders which have frequency response to 18 kHz. System One also permits operation at test tone frequencies down to 10 kHz with some increase in alias errors, for recorders such as consumer VCRs which have more limited high-frequency response.

Scrape flutter is normally measured with average detection-rms calibrated (NAB) characteristics. Measurement bandwidth in HIGH BAND mode is selectable over four bandwidths: 4 Hz bandpass (WTD), 0.5-200 Hz, 200 Hz-5 kHz, and 0.5 Hz-5 kHz. For a typical professional recorder which incorporates a scrape flutter idler, the below-200 Hz and above-200 Hz contributions will be approximately equal.

Despite the difference in test tone frequencies, the conventional and HIGH BAND modes yield near-identical readings if both are weighted or both are unweighted. The only change with the HIGH BAND mode is the extended measurement capability. The HIGH BAND mode can therefore be used for all measurements unless either a pre-recorded 3 or 3.15 kHz test tape is being used, or if the recorder has such limited frequency response that only the lower frequency test tone will pass through the machine.

17.4. Making Wow and Flutter Measurements

The wow and flutter analysis capability is selected as "W+F" on the MEASURE function line near the top of the ANALYZER panel. Three other fields on the analyzer control panel change when W+F is selected. The far right field on the DETECTOR line changes from the usual choices of RMS, AVG, Q-PK, and PEAK to IEC, NAB, and JIS. Selecting IEC enables a quasi-peak detector with dynamics ("ballistics") conforming to the IEC and DIN standards. Selecting NAB or JIS enables an average detector with approximate VU ballistics; however, JIS also enables a software algorithm that imparts a 4-5 second integration time constant to measurements for a heavily damped response.

Measurement bandwidth and test tone compatibility are selected on the FILTER line of the ANALYZER panel. Selecting WTD (weighted) or UNWTD (unweighted) will instruct the analyzer to assume a test tone or "carrier" frequency in the 2.8 kHz to 3.3 kHz band. To prevent the possibility of grossly inaccurate readings, the READING display will blank if the signal from the reproducing ma-

chine falls outside the 2.7 kHz to 3.4 kHz band. When WTD is selected, the weighting filter is inserted between the discriminator and detector stages. When UNWTD is selected, the measurement bandwidth is flat, extending from approximately 0.5 Hz to 200 Hz. The BANDWIDTH fields immediately above the FILTER line become indications, rather than selections, showing the approximate analysis bandwidth. With both WTD and UNWTD selections, these fields will display 0.5 Hz and 200 Hz.

The four selections ending with "-HB" (WTD-HB, UNWTD-HB, SCRAPE-HB, and WIDE-HB) instruct the analyzer to assume a nominal test tone or "carrier" frequency of 12.5 kHz. The READING display will blank if the signal drops below 7.5 kHz or exceeds 14 kHz. WIDE-HB selects the full bandwidth of the analyzer, extending from 0.5 Hz to approximately 5 kHz (typically 3 dB at 4.5 kHz). The exact response is significantly influenced by the test tone frequency and has been optimized for 12.5 kHz. Lower frequency test tones will exhibit degraded bandwidth and aliasing for FM products above half frequency. SCRAPE-HB selects a 200 Hz to 5 kHz analysis bandwidth, and UNWTD-HB selects a 0.5 Hz to 200 Hz bandwidth allowing relative comparisons between the scrape flutter and/or servo harmonic products versus rotational products. WTD-HB selects the same weighting filter used with 3 kHz-3.15 kHz test tones, permitting both weighted wow and flutter and scrape flutter measurements with the same test frequency.

When making wow and flutter measurements, the normal input autoranging feature of System One should be disabled. Tapes can exhibit momentary dropouts that might trigger ranging, causing a severe transient in the wow and flutter measurement. Fixing the input range is done by entering the maximum expected input level and unit selection in the appropriate RANGE field at CHANNEL A or CHANNEL B (whichever is being used) of the ANALYZER panel. The fields will display the closest available internal range. Selecting "AUTO" in the units field will restore autoranging. The analyzer has been designed to handle signals over a 30 dB window, giving ample margin with a fixed input range.

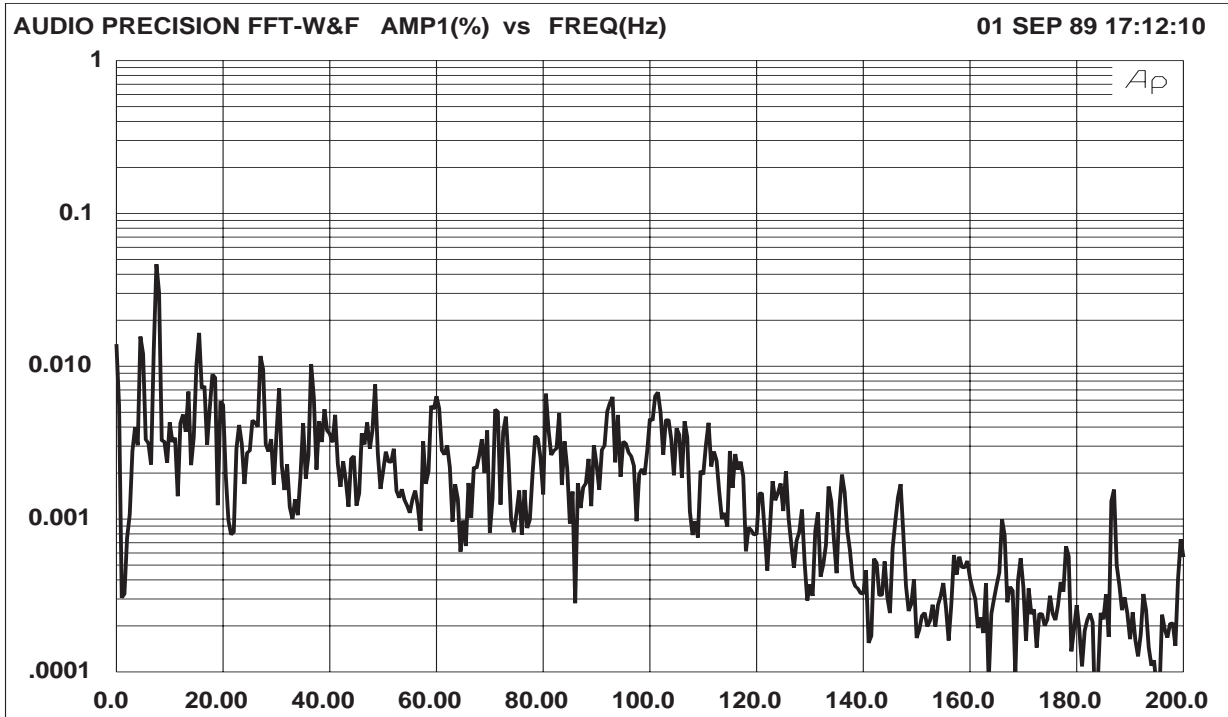

Figure 17-1 FFT Spectrum Analysis of Wow and Flutter. (Requires DSP Option)

The Audio Precision System One wow and flutter analyzer permits wow and flutter measurements up to at least 1.0% using a 3 kHz or 3.15 kHz test tone, and 2.5% using a 12.5 kHz test tone. A measurement of 0.5% represents an almost unlistenable level of wow and flutter. All measurements are displayed in a single range to avoid the long autoranging times of other analyzers that can be triggered by occasional tape dropouts. Measurement resolution is typically 0.0003% using a 3.0 kHz or 3.15 kHz test tone and 0.001% using a 12.5 kHz tone.

17.5. Spectrum Analysis of Wow & Flutter

With System One + DSP or System One Dual Domain, FFT spectrum analysis can be performed directly on the 3 kHz or 3.15 kHz tone or on the wow and flutter discriminator output. When acquiring signal at the discriminator (RDNG) output, a low sampling rate such as 1 kHz can be used since flutter signal bandwidth is limited to a few hundred Hz in the wow and flutter analyzer. The resulting frequency resolution can be as high as 0.06 Hz. This

degree of resolution permits clear separation of flutter-frequency components, as shown in Figure 17-1. If the flutter is being caused by defective rotating components, the circumference and diameter of the faulty component may be calculated from the measured flutter frequency and knowledge of the tape speed. For example, in the figure it can be seen that the dominant flutter frequency is 7.5 Hz. At the tape speed of 7.5 inches per second, this means that the flutter could be caused by a defective idler or capstan with a circumference of 1.00 inches (diameter of 0.318 inches). This is a powerful diagnostic technique for locating defective rotating components. The standard test files furnished with DSP units include a test already set up for the measurement shown.

17.6. Standards and Test Methods

The NAB flutter standard specifies that testing shall be made while reproducing a "flutter free" test tape. The flutter value is the average value of the peaks of the readings, excluding random peaks which do not recur more than three times in any 10-

Machine_____	Date_____	Tape speed_____		
Tape Type_____	Detector NAB / IEC / JIS (NAB preferred)			
	Beginning	Middle	End	
Weighted (4 Hz BP)				
Unweighted (0.5-200 Hz)				
Scrape (200 Hz-5 kHz)				
Wideband (0.5 Hz-5 kHz)				

Figure 17-2 Sample Table, Wow and Flutter Test Results

second period. Make readings at random intervals throughout the length of the test reel, splicing segments of the test tape into a full reel if necessary to test beginning, midreel, and end performance. To randomize the phase of the various flutter components, stop the tape between readings and turn each roller and idler slightly by hand.

The IEC flutter standard specifies that testing shall use a tape which has been recorded on the machine undergoing test. Do not conduct tests during simultaneous record/playback mode! The time delay caused by the physical spacing of the record and playback heads will cancel flutter components at frequencies given by the following expression:

$$\begin{aligned} & \text{Flutter cancellation frequency} \\ &= N * \frac{\text{tape speed}}{\text{gap-to-gap distance}} \\ &= \frac{N}{\text{time delay between heads}} \\ & \text{(where } N = 1, 2, 3, \dots \text{)} \end{aligned}$$

Although the standards indicate that only a single value of flutter is necessary, maintenance objectives are optimized by keeping written records of transport performance at the beginning, middle, and end of the tape reel.

Whenever possible, use the HIGH BAND measurement capability of System One to complete a test data table as shown in Figure 17-2, noting the detector type.

As a simpler but more comprehensive alternate to manually recording information in the table, a 10 second time sweep test (see Display Types section below) could be run under each of the twelve conditions listed in the table and each saved as test files with unique names; the additional information such as machine type, tape type, and tape speed can be recorded in Edit Comments mode and automatically saved with each test.

The NAB technique of reading a flutter-free tape in playback with an average-responding meter is an optimistic method. The IEC technique of record-playback with peak response yields readings which range from 1.5 to 3 times higher than the NAB values. The selected method is important only when comparing with the manufacturer's specifications. For normal maintenance, consistency from test to test is more important than the absolute method.

From a practical standpoint, the NAB method of using a standard test tape on reel-to-reel machines is very convenient, but some high-quality machines have flutter levels which are near or below the residual flutter in the test tape. If the flutter readings obtained from the test tape are higher than those ob-

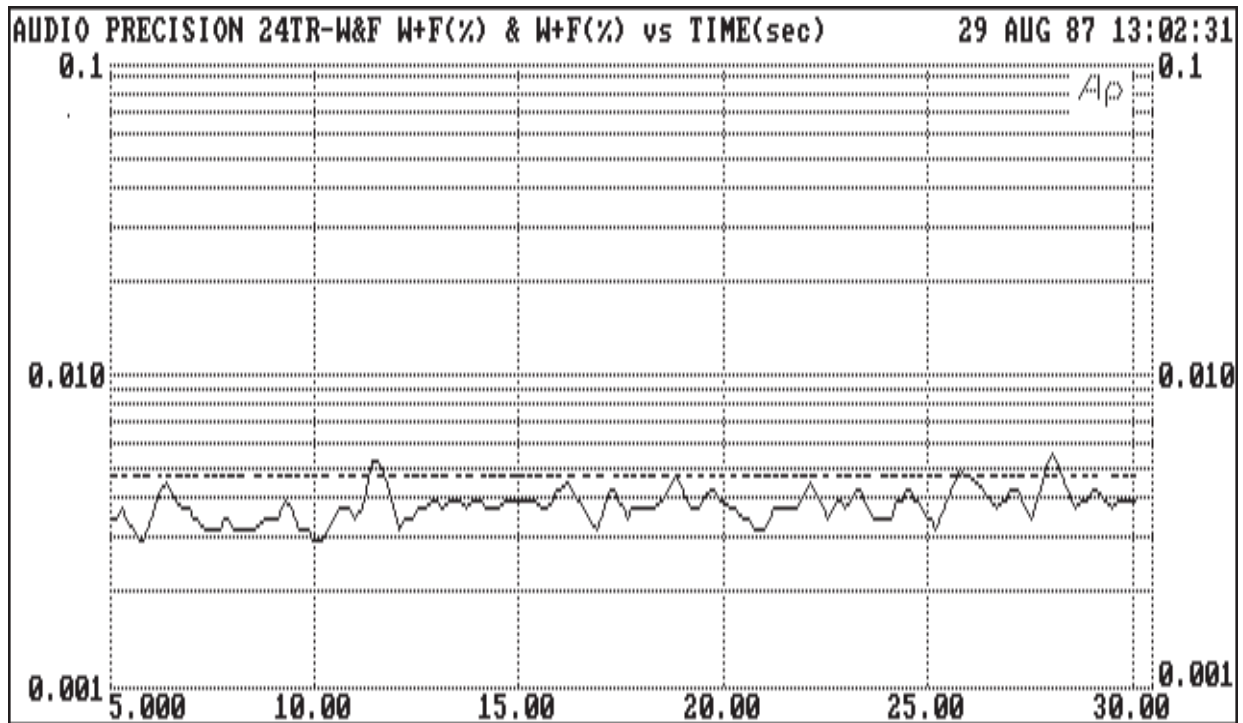

Figure 17-3 Wow and Flutter

tained using record-playback, the test tape has more flutter than the tape machine. Use the test tape only if it yields lower readings.

17.7. Display Types

Wow and flutter can be measured simply by observation of the digital indication on the reading line of the ANALYZER panel. It can also be monitored in the analog bargraph mode of System One by selecting RDNG as DATA-1 on the SWEEP (F9) DEFINITIONS panel and pressing the <F2> function key, or by selecting Run Bargraph from the menu. The end points of the bargraph will be controlled by the values entered for GRAPH TOP and GRAPH BOTTOM. When using the bargraph mode, it is also often desirable to enable the center and bottom bargraphs to display speed error (drift) and output level of the tape or disk player. To put speed error on the center bargraph, select ANLR and FREQ as DATA-2. Select delta % as the FREQ unit. This unit displays measured frequency in terms of percentage deviation from the value entered in the FREQ REF field near the bottom of the

ANALYZER panel. This value should be the frequency recorded on the test tape or disk, normally either 3.0 or 3.15 kHz. To display output level from the player on the bottom bargraph, select EXTERN LEVEL as the SOURCE-1 parameter and select the units and values desired for the ends of the bargraph as the START and STOP lines.

Wow and flutter can also be displayed versus time, in chart recorder fashion. Assuming that both wow and flutter and speed error are to be charted, select RDNG as DATA-1 and ANLR FREQ as DATA-2. Select EXTERN TIME as SOURCE-1. Choose the STOP time you wish; values of 10 to 30 seconds are often appropriate. To obtain fast update and many data points, choose the #STEPS value to produce perhaps 10 to 20 readings per second. For example, with a 10 second sweep, select #STEPS as 100 to 200. On the ANALYZER panel, select either AUTO or 16 or 32 readings per second on the DETECTOR line. Use the <PgDn> key to obtain the SWEEP SETTling panel, and turn SETTling OFF. This will result in readings from the hardware being directly plotted as they occur, rather than be-

ing compared against previous samples. Press <F9> and the time chart recording will take place, with instantaneous flutter and drift values being plotted.

It is sometimes desired to quote a single figure for wow and flutter, rather than presenting a stream of readings versus time. The COMPUTE 2-SIGMA menu command was designed for that purpose. COMPUTE 2-SIGMA calculates the value which was exceeded for 5% of the time, and replaces the original data with that value. The F7 key will thus re-plot with a horizontal line at the 2 sigma value. If it is desired to retain both the original data varying with time and the 2 sigma value, the test can initially be set up with RDNG selected at both DATA-1 and DATA-2. COMPUTE 2-SIGMA can then be invoked only for DATA-2, for example. The F7 re-plot will then show the original data as the solid (green) line and the 2 sigma value as the dashed (yellow) line. See Figure 17-3 for an example of this technique on a high-quality professional multi-track tape recorder.

18. SWITCHER MODULES

18.1. Introduction

Audio Precision's SWR-122 switcher family is designed for use with System One in the testing of multiple input-output devices such as mixing consoles, multi-track tape recorders, audio routing switchers, distribution amplifiers, or multiple units of simpler units during burn-in, environmental test, and similar activities. One of the versions is a patch-point switcher which can be connected at a number of points in an audio chain or a console input channel. It permits signal measurements at any of these points, or allows breaking the normal path, measuring the unloaded output of the previous stage, and driving the following stage with the System One generator.

18.2. Functional Description

The SWR family of switchers is available in four versions:

- input switcher with XLR connectors (SWR-122F)
- output switcher with XLR connectors (SWR-122M)
- patch-point switcher with 5-pin XLR connectors (SWR-122P)
- connectorless, terminal strip version (SWR-122T) which can be configured in any of the above three functional types.

All four of the Audio Precision switchers use the same circuit board. They differ from one another in connector configuration and in attributes set by internal jumpers, which define them as an input switcher (connecting multiple device outputs to the analyzer inputs), an output switcher (connecting generator outputs to multiple inputs of devices), or a patch-point switcher.

Each of the switchers is a 12 x 2 crosspoint matrix, hence the SWR-122 nomenclature. Either of the two common points can be connected, under software control, to any of the twelve selectable points. All the switchers are of balanced design but may be used with unbalanced circuits. Up to 16 modules of the input and/or output switcher may be stacked and connected in daisy-chain fashion to permit testing devices with up to 192 inputs and/or outputs (up to 96 stereo pairs). Rear panel programming switches permit setting the address of each module in a stacked-module system for the desired channel number selections—1 through 12, 13 through 24, etc. Figure 18-1 is a simplified diagram pertaining to all versions. The relay contacts shown as single switches are actually multiple relay contacts connected in a more complex arrangement. This is necessary to obtain the isolation and crosstalk required for practical professional and high-grade consumer applications.

18.2.1. Input Switcher

The input switchers function basically as the simplified diagram indicates. Any of up to 12 balanced circuit points per module (192 with the maximum 16 modules stacked) may be connected to either the A or B connector, which would in turn normally be connected to the A and B inputs of the System One analyzer. The SWR-122F version of the input switcher has two male XLR connectors for connection to the analyzer inputs, and 12 female XLR connectors for connection to device outputs. The connectorless terminal strip version SWR-122T may be configured as an input switcher.

18.2.2. Output Switcher

The usual function of the output switcher is to connect System One generator outputs to a number of device inputs. It is electrically different from the input switcher in that it also has the capability of

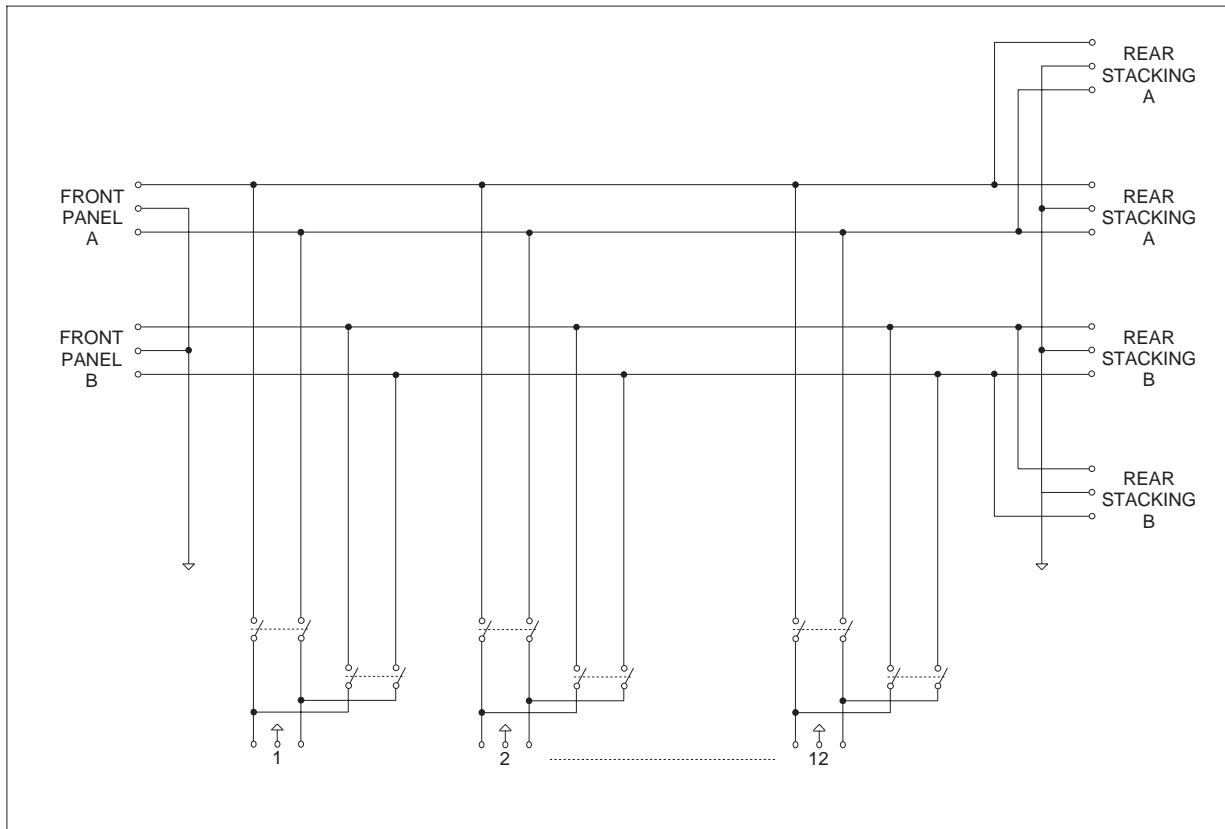

Figure 18-1 Simplified Diagram, Switchers

connecting one output of the generator to all but one input of a device, such as a routing switcher. The output of that one non-driven channel may then be measured to obtain a worst-case crosstalk measurement. The SWR-122M version has two female and 12 male XLR connectors. The connectorless terminal strip version SWR-122T may be configured as an output switcher.

18.2.3. Patch Point Switcher

The patch point switcher differs considerably from the input and output switchers, even though it uses the same circuit board. The two “common” connectors of the patch point switcher are a female connector (INPUT) for connection to an output of the generator and a male connector (OUTPUT) for connection to an input of the analyzer. The twelve connectors of the SWR-122P version are 5-pin XLR connectors. They are designed for connection at ma-

ior circuit nodes of a console, or between series-connected devices in an audio chain in a studio, transmitter, or sound reinforcement system. Pins 1 (high) and 2 (low) connect to a balanced output of the preceding device. Pin 3 is ground. Pins 4 (high) and 5 (low) are the balanced input of the following stage or device. Figure 18-2 is a simplified diagram of the patch-point switcher. Although the diagram shows a single-ended architecture, all circuits are actually balanced. The connectorless terminal strip version SWR-122T may be configured as a patch-point switcher.

In the normal mode of the patch point switcher (power off, or no channel selected) the previous stage or device is directly connected to the input of the following stage or device. By selecting an INPUT channel from the control panels of System One, it is also possible to connect the analyzer input across any normalled-through connection to measure level, distortion, noise, response, etc. It is also possi-

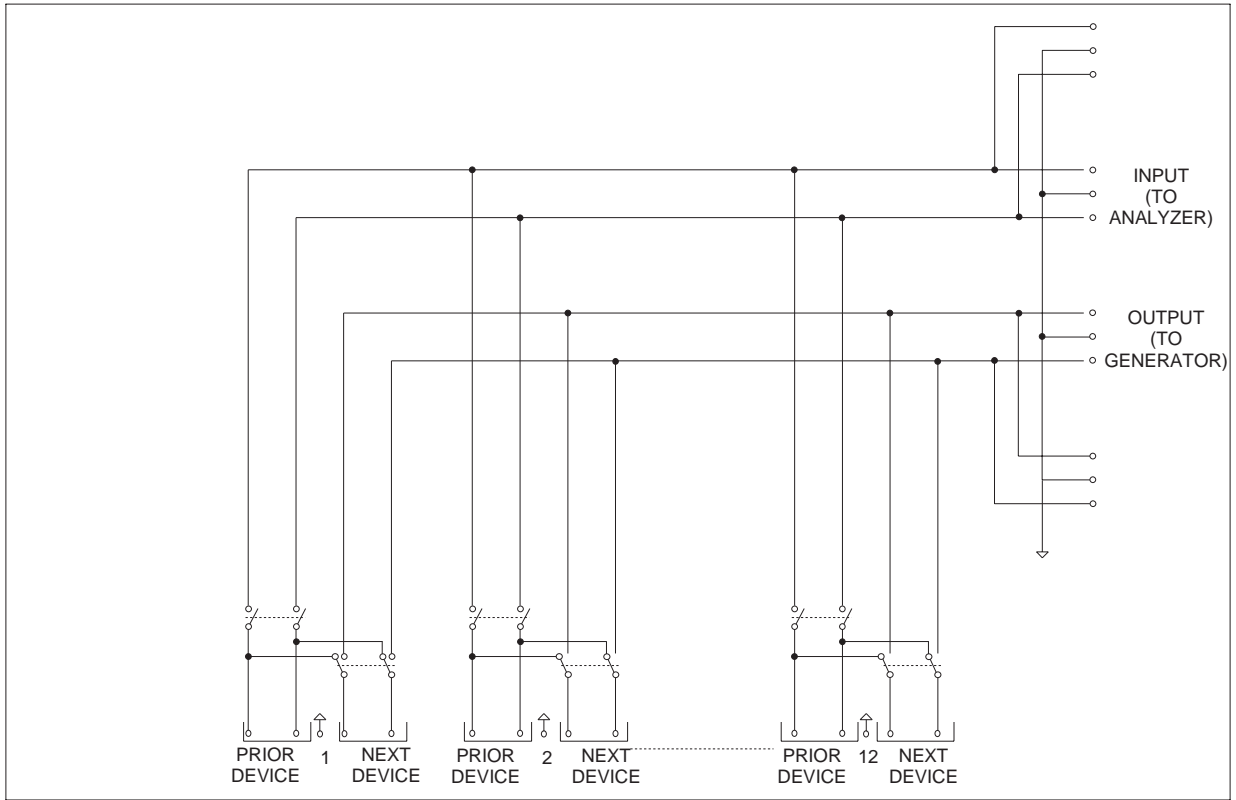

Figure 18-2 Simplified Diagram, Patch Point Switcher

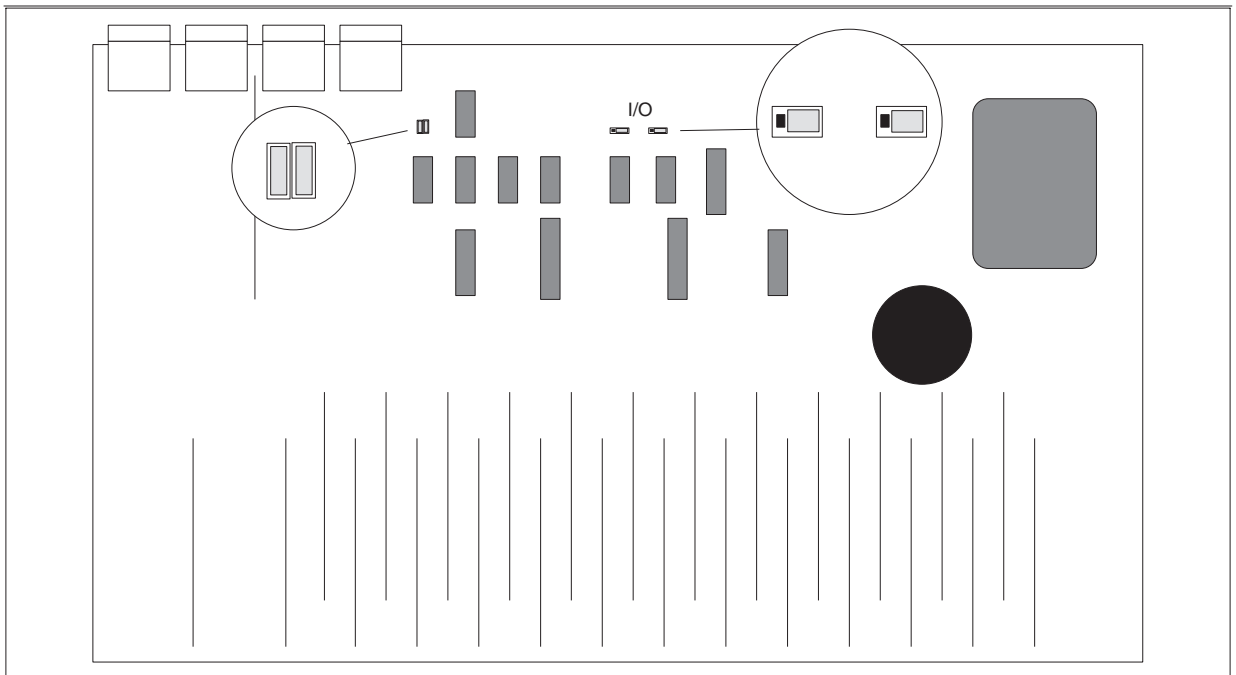

Figure 18-3 Jumper Locations, Output Switcher

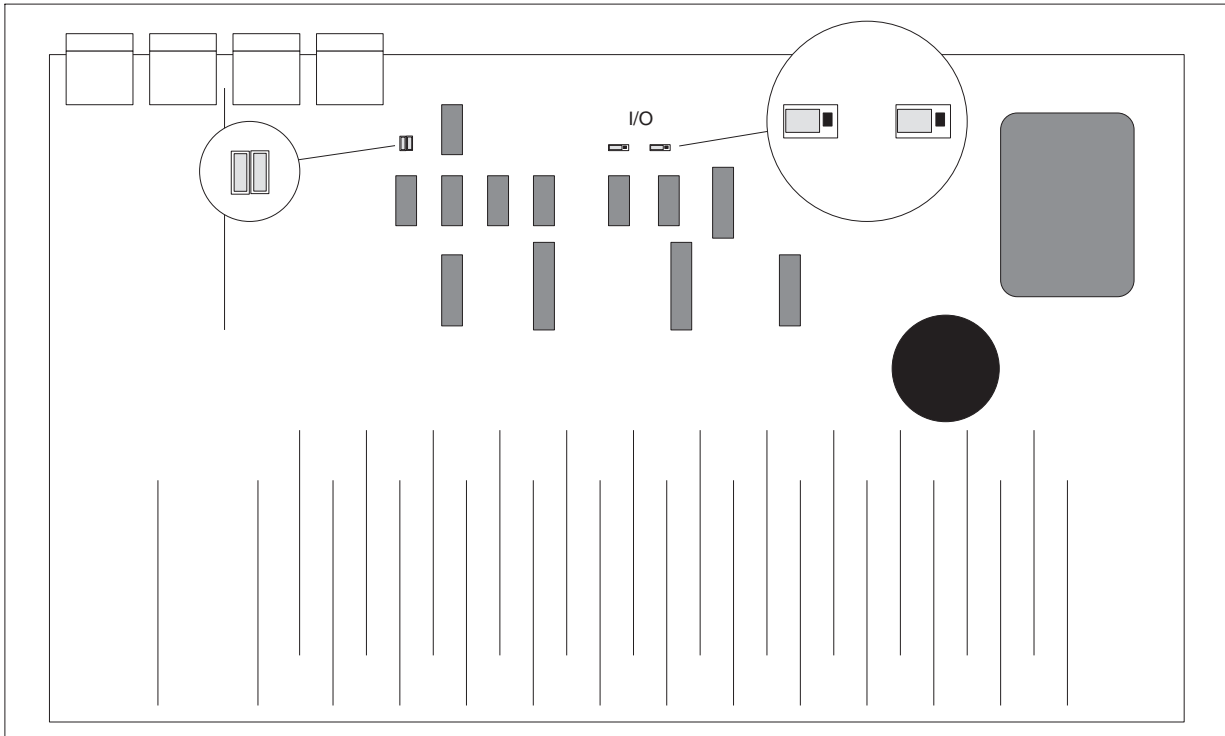

Figure 18-4 Jumper Locations, Input Switcher

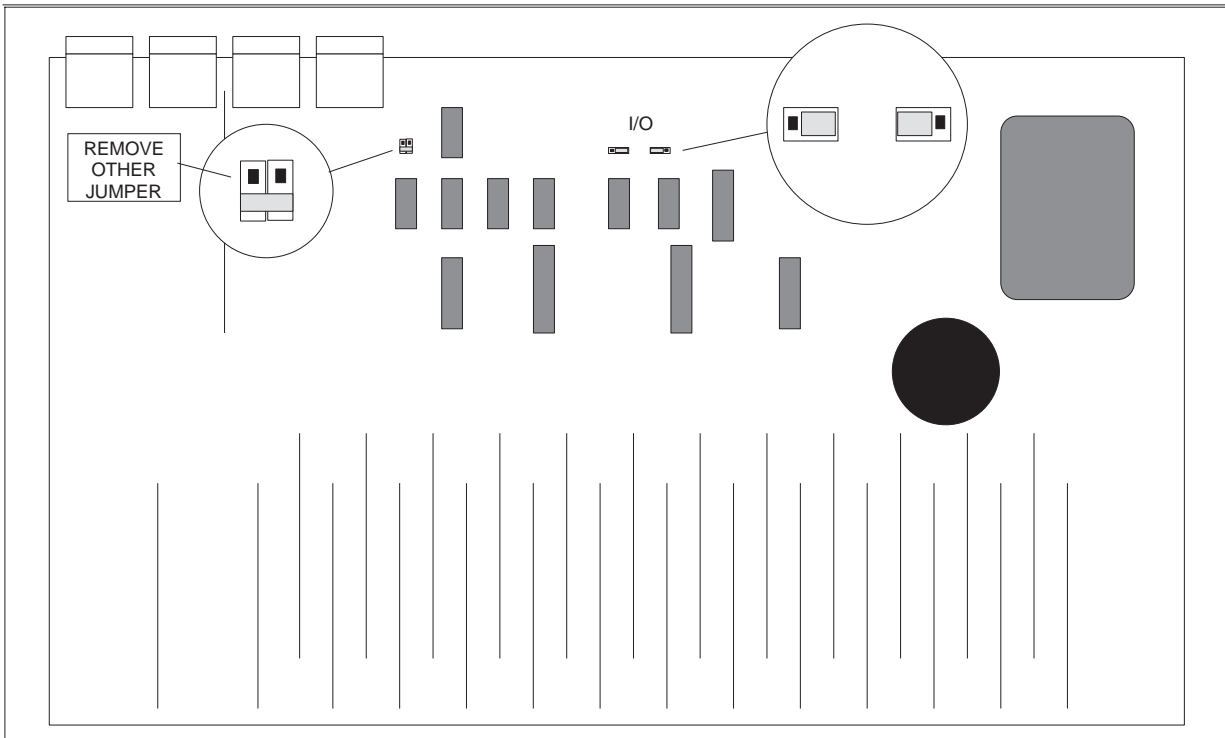

Figure 18-5 Jumper Locations, Patch Point Switcher

ble to break the normalled-through connection by selecting an OUTPUT channel number from the software control panel, so that the previous stage or device may be measured in an unloaded condition. If the relevant generator output channel is turned on when an OUTPUT channel is selected, it will drive the following stage or device. For stereo systems and devices, two of the patch-point switchers may be designated as A and B and used together to simultaneously access both stereo channels.

18.2.4. Terminal Strip Switcher

The terminal strip switcher SWR-122T has five-screw connector blocks in place of XLR connectors. It may be configured as an input switcher, output switcher, or patch-point switcher as described below. Note that the isolation and crosstalk specifications of the SWR-122 family of switchers apply only to the connector blocks of the terminal strip version. The user must take precautions with shielding and lead dress if these specifications are to be maintained on through the user cable assemblies to the device under test.

18.2.4.1. Jumper Selection

The switcher circuit board has four jumpers on it when shipped from the factory. They are diagrammed in Figure 18-3, Figure 18-4, and Figure 18-5.

The two jumpers marked I/O are located near the two 25-pin D subminiature connectors on the rear panel. These select between INPUT and OUTPUT modes of the switcher. The input and output positions are marked above the two jumpers, input being away from the power transformer and output being toward the transformer.

The other two jumpers are located near the six-position rocker switch assembly on the rear panel. They select whether the switcher responds to Channel A or Channel B commands. When both jumpers are side by side, they bypass the rear panel A and B rocker switches. They must be in this position for the input or output versions of the switcher. This is the position in which they are shipped from the fac-

tory. If a PATCH POINT switcher configuration is desired, one of these jumpers must be removed and the other rotated 90 degrees and placed on the pair of pins closest to the 74HCT74 integrated circuit. With the jumper in this position, the rear panel A and B rocker switches will select the desired channel for switcher operation.

18.2.4.2. Input/Output Connections

The connections to and from the device under test are made through the twelve terminal strips located near the front panel of the switcher. The wiring for these connectors is as follows:

- 1 high signal from device under test output
- 2 low signal from device under test output
- 3 ground
- 4 high signal to device under test input
- 5 low signal to device under test input

When used as in INPUT or OUTPUT switcher, the corresponding XLR connections are as follows:

- 1 XLR pin 2 (signal high)
- 2 XLR pin 3 (signal low)
- 3 XLR pin 1 (ground)
- 4 not used
- 5 not used

When the terminal strip switcher is shipped from the factory, pins 1 and 4 are connected together and pins 2 and 5 are connected together on the circuit board itself. If the switcher is to be used as a PATCH POINT switcher, the appropriate circuit board traces must be cut. Figure 18-6 shows how this is done on circuit boards of switchers before serial number 20000. Switchers after serial number 20000 can be modified by cutting traces as shown in Figure 18-7. Once these traces are cut, operation as

an INPUT or OUTPUT switcher will require wire jumpers to be inserted in the screw terminals between pins 1 and 4 and between pins 2 and 5.

Connections to System One and to the other switchers in the system are made via the XLR connectors at the rear of the switcher. The Channel A stacking connectors on the rear panels should be connected from switcher to switcher with the last one of the chain connected to the appropriate System One Channel A connector. The Channel B stacking connectors on the rear panels should be connected from switcher to switcher with the last one of the chain connected to the appropriate System One Channel B connector.

The PATCH POINT version switcher uses the connectors marked Channel A as the input connections. These should be daisy-chained to the other switchers in the system and connected to one channel of the System One generator output. The Channel B connectors are used as the output connectors and should be connected to the corresponding channel of the analyzer input. This channel is then selected by setting the corresponding rocker switch, A or B, on the rear of the switcher to the up position.

18.3. Installation

Switcher installation consists of physically mounting the switcher modules, setting the ac mains voltage range switch, providing proper ac mains power, electrically interconnecting them, and setting rear panel switches for address and function. Physically, the switcher modules may be either rack-mounted or simply stacked on top of one another. Ac mains connections are made via standard IEC connectors. A rear panel switch selects the nominal 100-120 Volt or 220-240 Volt ranges. No power switch is provided; the units are designed for continuous service.

Electrically, the digital control connectors of the switchers must be connected in “daisy-chain” fashion. Normally, the computer will be connected to the first switcher with a digital interface cable, the first switcher connects to the second, etc., and the last switcher connects to the System One digital con-

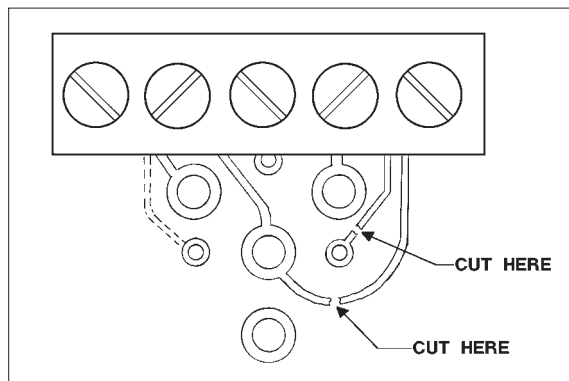

Figure 18-6 Tracks to Cut to Convert Terminal Strip to Patch Point Switcher, Below S/N 2000

nectors. Each switcher has both a male and female digital interface connector on its back panel for these connections. When more than one module of a given type (input, output, or patch-point) is used in a system, rear panel address switches must also be set. The four left-hand switches on the binary switch bank on the rear panel set the module address. The relationship between rear panel address switch position, binary code, and channel number on the computer software “panels” is shown in Figure 18-8.

In a patch point switcher the two right-hand switches (viewed from the rear) select channel A or channel B operation as shown in Figure 18-9. These switches are disabled in input or output versions of the switcher.

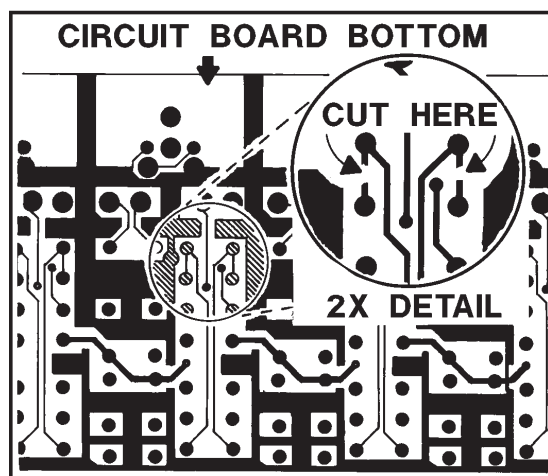

Figure 18-7 Tracks to Cut to Convert Terminal Strip to Patch Point Switcher, S/N 2000 and Above

REAR PANEL SWITCH SETTINGS				BINARY CODE	CHANNEL NUMBERS
#8	#4	#2	#1		
up	up	up	up	0000	1-12
up	up	up	down	0001	13-24
up	up	down	up	0010	25-36
up	up	down	down	0011	37-48
up	down	up	up	0100	49-60
up	down	up	down	0101	61-72
up	down	down	up	0110	73-84
up	down	down	down	0111	85-96
down	up	up	up	1000	97-108
down	up	up	down	1001	109-120
down	up	down	up	1010	121-132
down	up	down	down	1011	133-144
down	down	up	up	1100	145-156
down	down	up	down	1101	157-168
down	down	down	up	1110	169-180
down	down	down	down	1111	181-196

Figure 18-8 Switcher Address Switch Settings

Patch point switchers, input switchers, and output switchers may all be combined in the same system. Input and output switchers may share the same address. A patch point switcher must not have the same address as either an input or output switcher. Two patch point switchers may be set to the same address if one is set as Channel A and the other as Channel B.

Audio signal connection must also be connected in daisy-chain fashion via the rear panel XLR connectors. Normally, the generator and analyzer outputs and inputs will connect to the front panel inputs and outputs of the first pair of switcher modules (assuming multiple units of both input and output

REAR PANEL SWITCH	PATCH PT MODE	
A	B	
down	down	OFF
down	up	CHANNEL B
up	down	CHANNEL A
up	up	EITHER A OR B

Figure 18-9 Patch Point Switcher Channel Selection

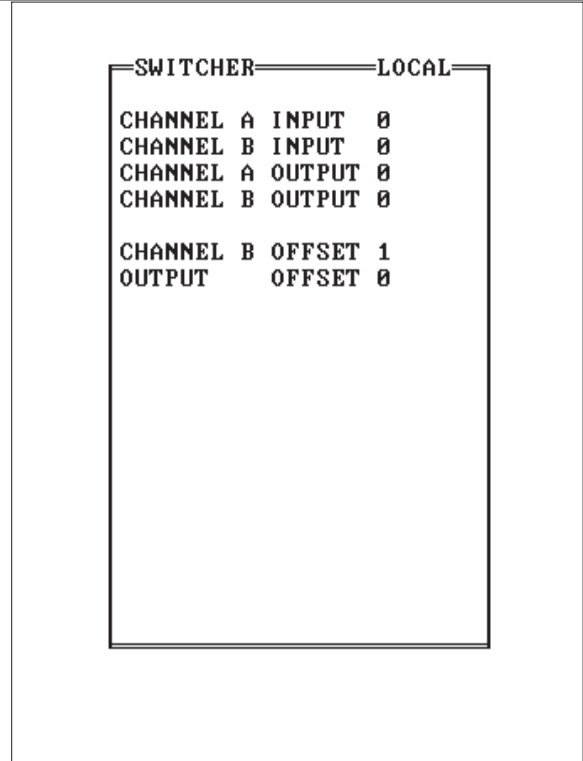

Figure 18-10 Switcher Control Panel

switchers are being used). The rear panel XLRs will then be used to connect channels A and B of the first input switcher module to A and B of the next input switcher, etc.

18.4. Control of Switchers

Audio Precision's switchers may be controlled from two portions of the standard System One software panels; from the SWITCHER control panel, or in a "sweep" (scan) mode from the SOURCE-1 or SOURCE-2 lines of the SWEEP (F9) DEFINITIONS panel.

18.4.1. Switcher Control Panel

The SWITCHER control panel (Figure 18-10) can be brought on screen via the <PgDn> and <PgUp> keys. The SWITCHER panel may also be combined with any two other panels by placing the cursor on a panel to be exchanged, then pressing <Ctrl><PgDn> or <Ctrl><PgUp> to rotate the off-screen panels through until the SWITCHER panel is obtained. Thus, it is possible to obtain a screen consisting of the GENERATOR panel, the ANALYZER panel, and the SWITCHER panel.

A switch is closed from the SWITCHER panel simply by entering a number from the keyboard into the desired field on the CHANNEL A INPUT, CHANNEL B INPUT, CHANNEL A OUTPUT, or CHANNEL B OUTPUT line. Alternately, the <+> and keys at the lower right of most IBM-compatible keyboards may be used to increment or decrement the switcher position when the cursor is on the appropriate numeric field. When 0 is entered, none of the relays are selected. If a number outside the range of installed switchers is entered, none are selected.

The SWITCHER panel also permits setting two values of offset. The B OFFSET value controls the number of channels by which the B channel selection will be offset from the A channel selection during AB mode sweeps (see below). The OUTPUT

OFFSET controls the number of channels by which the output switcher will be offset from the input switcher during I/O sweeps (see below).

18.4.2. Driving All But One Channel

The "complement" mode of the output switcher permits driving all but one output. This mode is used for worst-case crosstalk testing of multi-channel devices. To select the complement mode, enter the channel number of the one channel which is not to be driven as CHANNEL A OUTPUT. Enter -1 as CHANNEL B OUTPUT. The -1 is a code telling the switcher to complement all channels; thus, the single channel selected at Channel A will not be driven and all others (up to 191 in a maximum case) will be driven. If 0 is entered as CHANNEL A OUTPUT and -1 is entered in CHANNEL B OUTPUT for the complement mode, all output channels will be driven. Complement mode results in direct parallel connections of all but the selected channel to the generator B output, so the load impedances seen by the generator will be reduced and maximum output amplitudes may not be obtainable.

Control of the switchers via the SWITCHER panel is intended for impromptu, unstructured selection of switcher position, or for cases where every test (xx.TST file) has a specific switcher configuration which goes with it. Tests of a consumer stereo preamplifier could be one example of this mode. The moving coil phono preamp inputs, moving magnet preamp inputs, tuner inputs, and AUX-1 and AUX-2 inputs of a preamplifier all need to be tested. The required levels will be different at each of the phono preamp inputs versus the high-level inputs. Different tests will be performed on each channel; RIAA equalization will be used on the generator for the phono input tests, different noise limit values will be appropriate for each input, etc. Each input will thus normally be tested via a series of tests in a procedure, and each of those tests will specify the required switcher configuration simply by setting it on the SWITCHER panel as the test is set up and saved. Each preamplifier to be tested will then be connected to the switcher outputs (perhaps via a plug-in fixture) and the procedure will

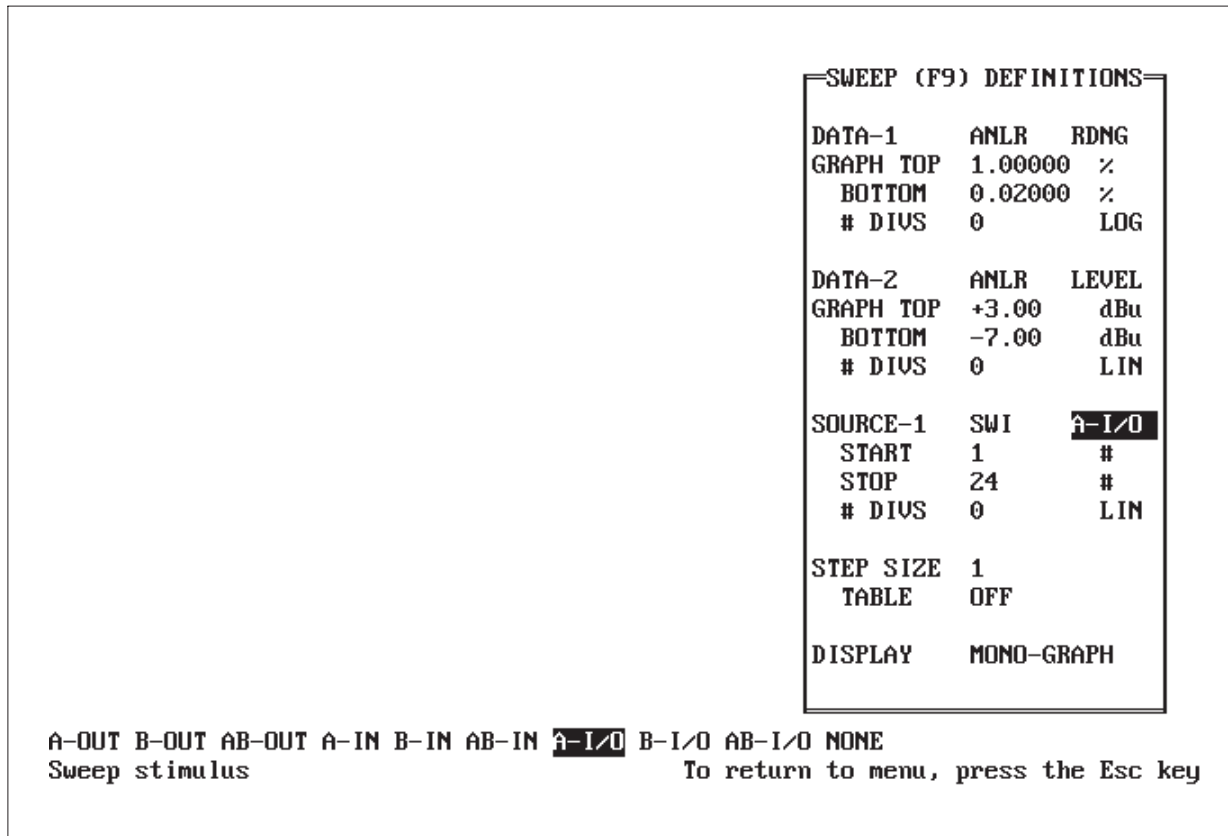

Figure 18-11 Sweep Test Definitions Panel for Switcher Scans

automatically select the correct connections as it loads and runs the appropriate tests. An example of such a set of tests is described later in this chapter.

As with generator amplitude and frequency, the SWITCHER panel determines what the conditions will be before and after a sweep or scan if the switchers are specified on the SOURCE-1 or SOURCE-2 lines of the SWEEP (F9) DEFINITIONS panel as described below.

18.4.3. Sweep (F9) Definitions Panel

The switchers may also be controlled in a scanning or sweeping fashion during a test, or from the mouse or keyboard in bargraph mode, via the SWEEP (F9) DEFINITIONS panel; see Figure 18-11. The one or two analyzer parameters selected at DATA-1 and DATA-2 may be measured across a number of channels by selecting SWI as SOURCE-

1, then selecting the scanning mode. If F2 is pressed for bargraph display, the horizontal arrow keys or mouse can select the switcher channel or the increment <+> and decrement keys can be used to step the switcher in one-channel increments. This can be particularly convenient when aligning a multi-track tape recorder. The available scanning modes and their functions are:

- A-OUT: sequentially scans the output switcher's A channel (which typically is fed from the generator A output) to the selected output channels. The output switcher B channel and the input switcher channels remain connected as selected on the SWITCHER panel.
- B-OUT: scans the output switcher's B channel (typically fed from the generator B output) in sequence to the selected output channels. The output A channel and input channels remain as selected on the SWITCHER panel.

- **AB-OUT:** synchronized but offset scan of both the A and B channels of the output switcher, with the B channel offset from the A channel selection by the value entered on the SWITCHER panel as B OFFSET. For example, if A is connected to channel 9 and the B OFFSET value is 4, B will be connected to channel 13. A common application is scanning paired outputs of stereo systems using STEP SIZE 2 and B OFFSET of 2, and scanned crosstalk measurements to the adjacent track of multi-track tape recorders. The input channels remain as selected on the SWITCHER panel.
- **A-IN:** scans the input switcher's A channel (typically connected to the analyzer A input) sequentially across the selected input channels. The input B channel and output channels remain as selected on the SWITCHER panel.
- **B-IN:** scans the input switcher's B channel (typically connected to the analyzer B input) in sequence to the selected input channels. The input A channel and output channels remain as selected on the SWITCHER panel.
- **AB-IN:** synchronized but offset scan of both the A and B channels of the input switcher, with the B channel offset from the A channel selection by the number of channels entered as B OFFSET on the SWITCHER panel. Applications include scans of stereo systems or devices using B OFFSET 2 and STEP SIZE 2, and scanned crosstalk measurements to the adjacent track of multi-track tape recorders. The output channels remain as selected on the SWITCHER panel.
- **A-I/O:** scans both the output switcher A channel and the input switcher A channel in sequence across the specified output and input channels. If OUTPUT OFFSET on the SWITCHER panel is 0, both input and output channel numbers will be the same. If OUTPUT OFFSET is any other value, the output switcher will be offset from the input switcher

by that specified number of channels. The B channels remain as selected on the SWITCHER panel.

- **B-I/O:** scans both the output switcher B channel and the input switcher B channel in sequence across the specified output and input channels. OUTPUT OFFSET functions as described above. The A channels remain as selected on the SWITCHER panel.
- **AB-I/O:** synchronized but offset scan of both the A and B channels of both the input and output switchers. The B channel will be offset from the A channel by the B OFFSET value on the SWITCHER panel. The output channel will be offset from the input channel by the OUTPUT OFFSET selection on the SWITCHER panel. Applications include scans of stereo systems or devices using STEP SIZE 2, and scanned crosstalk measurements to the adjacent track of multi-track tape recorders.
- **NONE:** no switcher scanning takes place; connections remain as specified on the SWITCHER panel.

18.4.4. Nested Switcher Scans

The switchers may also be scanned in a nested fashion with other parameters such as generator amplitude or frequency, analyzer bandpass filter frequency, or external frequency, amplitude, or time. The parameter selected as SOURCE-1 on the SWEEP (F9) DEFINITIONS panel will proceed through one sweep or scan with the value of the SOURCE-2 parameter specified on the GRAPH BOTTOM line at the center of the panel (usual DATA-2 area). The SOURCE-2 parameter will then take one step toward the GRAPH TOP value and the SOURCE-1 parameter will scan or sweep again, etc. See Figure 18-14 on page 18-13 for an example.

18.5. Typical Switcher Applications

18.5.1. Stereo Control Preamplifier

Assume that a stereo preamplifier/control center is to be tested. It has inputs for moving coil phono cartridges, moving magnet cartridges, and three sets of high level inputs. The moving coil inputs have the greatest gain (and equivalent input noise), followed by the moving magnet inputs. All high level inputs have less gain. Both sets of phono inputs are RIAA-equalized. Assume that gain, signal-to-noise, frequency response, and thd versus frequency tests are to be run from each set of phono inputs and one set of high level inputs, plus gain tests only on the remaining high level inputs.

A single output switcher module with no input switchers is sufficient, as shown in Figure 18-12. Four moving-coil tests would be set up and saved, with generator levels appropriate for the moving coil pre-amp sensitivity, with RIAA pre-emphasis files attached to the generator and EQSINE selected. We will name them MC-GAIN.TST, MC-SIGNO.TST, MC-FRQRS.TST, and MC-THD.TST. All would be STEREO tests (DATA-2 line); all four would have their SWITCHER panels set as follows:

CHANNEL A INPUT 0
 CHANNEL B INPUT 0
 CHANNEL A OUTPUT 1
 CHANNEL B OUTPUT 2

Four moving-magnet pre-amp tests would be saved by modifying the four tests above to the higher generator level appropriate for this input, and changing the SWITCHER panel to read:

CHANNEL A INPUT 0
 CHANNEL B INPUT 0
 CHANNEL A OUTPUT 3
 CHANNEL B OUTPUT 4

They would be saved as MM-GAIN.TST, MM-SIGNO.TST, MM-FRQRS.TST, and MM-THD.TST.

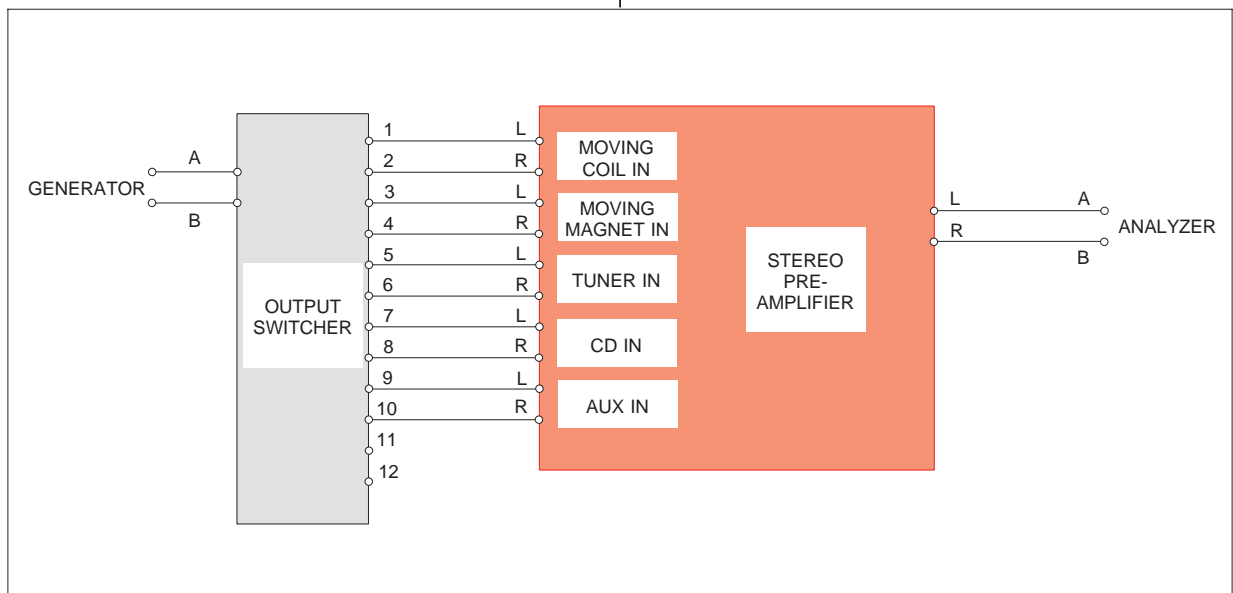

Figure 18-12 Switcher for Stereo Preamplifier Tests

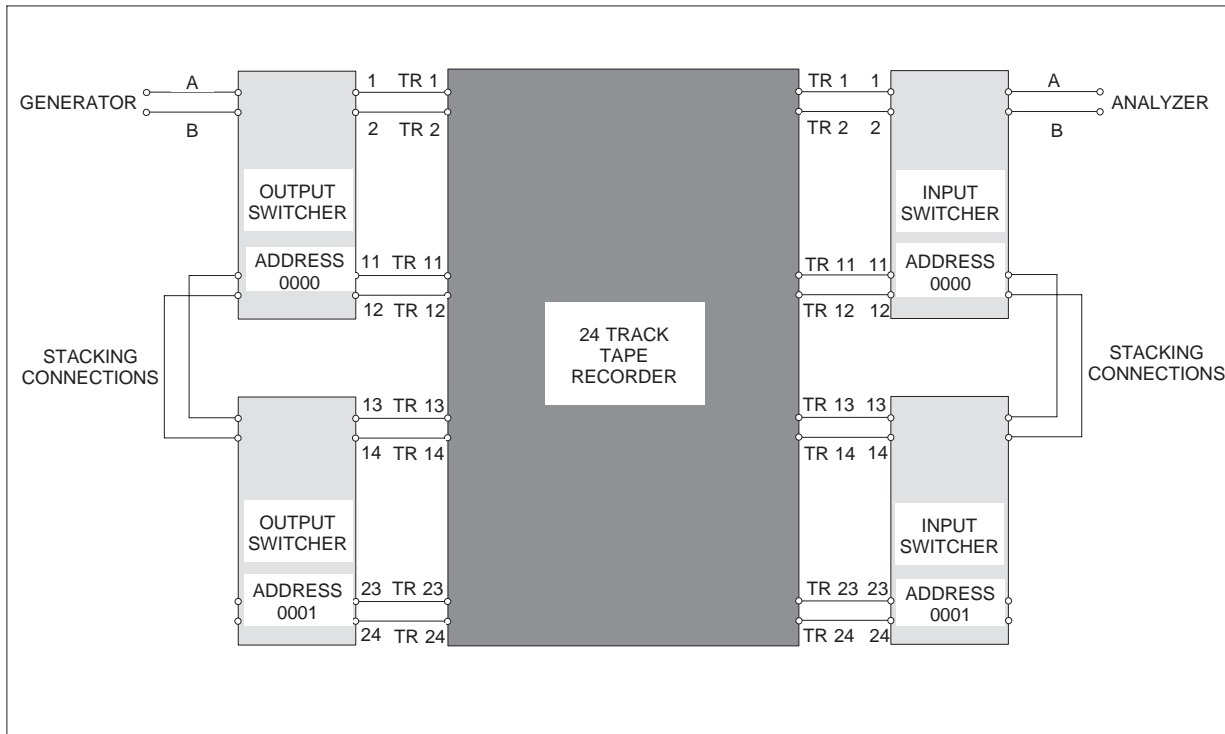

Figure 18-13 Switchers for Multi-Track Tape Recorder Tests

These tests would then be further modified to a still-higher generator level appropriate for the high level inputs, the RIAA equalization file would be removed and SINE selected instead of EQSINE, and the SWITCHER panel set to:

CHANNEL A INPUT 0

CHANNEL B INPUT 0

CHANNEL A OUTPUT 5

CHANNEL B OUTPUT 6

They would be saved as HL1-GAIN.TST, HL1-SIGN.TST, HL1-FRQ.TST, and HL1-THD.TST.

Finally, a test called HL2-GAIN.TST would be saved with the SWITCHER panel set to

CHANNEL A INPUT 0

CHANNEL B INPUT 0

CHANNEL A OUTPUT 7

CHANNEL B OUTPUT 8

and a test called HL3-GAIN.TST would be saved with SWITCHER positions

CHANNEL A INPUT 0

CHANNEL B INPUT 0

CHANNEL A OUTPUT 9

CHANNEL B OUTPUT 10

These fourteen tests could then be linked into a procedure. Acceptance limits could be created for all of them, and an error file named for the final test report. See the chapters following for more information on these capabilities.

18.5.2. Multi-track Tape Recorder

A multi-track tape recorder is basically a number of semi-independent monaural signal channels. Assume that a 24-track machine is to be tested for fre-

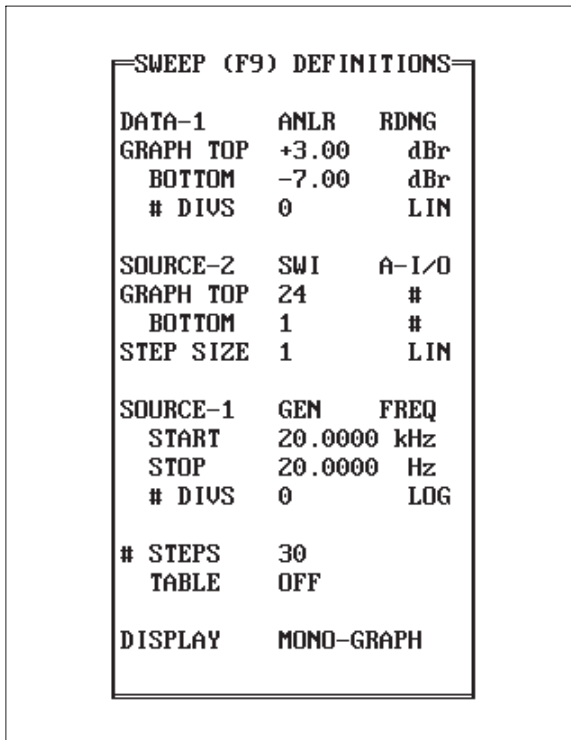

Figure 18-14 Sweep Panel for 24 Track Freq Resp

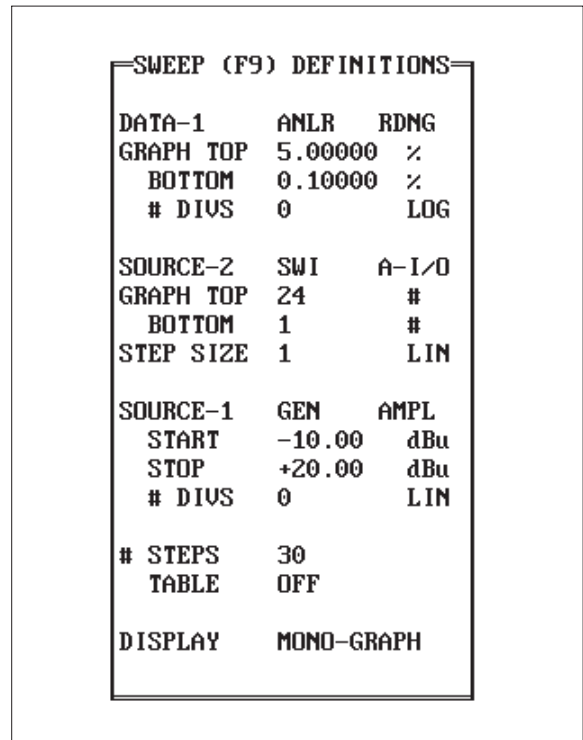

Figure 18-16 Sweep Panel for 24 Track MOL

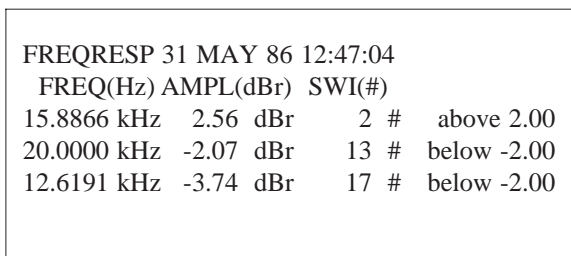

Figure 18-15 Error File from 24 Track Response Test

quency response, THD vs amplitude (MOL), THD vs frequency, and spectral distribution of noise on each channel. Furthermore, "gap scatter" (phase variation from a center track to all other tracks) is to be measured and crosstalk is to be measured from all tracks (simultaneously) to each track under test.

Two output switchers and two input switchers are required to automate the testing of a 24-track tape recorder, as shown in Figure 18-13. The rear panel address switches of the second output and second input switcher would be set to binary 0001, which will make them respond to the software as channels 13 through 24. The frequency response, two thd

sweeps (one versus amplitude and one versus frequency), noise spectral distribution sweeps, and worst-case crosstalk can each be set up as a single xx.TST file by using nested sweep capability. The same limit file(s) will then apply to a given parameter for all 24 channels, and a single error file will show any outside-specification measurements identified by channel number. The gap scatter test will be a sixth test.

SWEEP (F9) DEFINITIONS panels will be shown for all six tests. For frequency response on all 24 tracks, the panel will be as shown in Figure 18-14. Note that OUTPUT OFFSET on the SWITCHER panel must be set to 0 so that both input and output switchers will connect to the same channel at all times.

The switchers will select the input and output of track 1, and response will be measured from 20 kHz to 20 Hz; the switchers will step to track 2 and the response sweep will be repeated, etc. All 24 response sweeps will be drawn on the same graph if DISPLAY MONO-GRAPH or DISPLAY COLOR-

SWEEP (F9) DEFINITIONS		
DATA-1	ANLR	RDNG
GRAPH TOP	5.00000	%
BOTTOM	0.10000	%
# DIVS	0	LOG
SOURCE-2	SWI	A-I/O
GRAPH TOP	24	#
BOTTOM	1	#
STEP SIZE	1	LIN
SOURCE-1	GEN	FREQ
START	10.0000	kHz
STOP	20.0000	Hz
# DIVS	0	LOG
# STEPS	30	
TABLE	OFF	
DISPLAY	MONO-GRAPH	

Figure 18-17 Sweep Panel, 24 Track THD+N

SWEEP (F9) DEFINITIONS		
DATA-1	ANLR	RDNG
GRAPH TOP	-0.00	dBu
BOTTOM	-100.00	dBu
# DIVS	0	LIN
SOURCE-2	SWI	A-I/O
GRAPH TOP	24	#
BOTTOM	1	#
STEP SIZE	1	LIN
SOURCE-1	ANLR	BPBR
START	20.0000	kHz
STOP	20.0000	Hz
# DIVS	0	LOG
# STEPS	30	
TABLE	OFF	
DISPLAY	MONO-GRAPH	

Figure 18-18 Sweep Panel for 24 Track Noise

SWITCHER	LOCAL	SWEEP (F9) DEFINITIONS		
CHANNEL A INPUT	0	DATA-1	ANLR	PHASE
CHANNEL B INPUT	12	GRAPH TOP	+50.0	deg
CHANNEL A OUTPUT	0	BOTTOM	-50.0	deg
CHANNEL B OUTPUT	12	# DIVS	0	LIN
CHANNEL B OFFSET	1	DATA-2	ANLR	NONE
OUTPUT OFFSET	0	GRAPH TOP		OFF
		BOTTOM		OFF
		# DIVS	0	LOG
		SOURCE-1	SWI	A-IN
		START	1	#
		STOP	24	#
		# DIVS	0	LIN
		STEP SIZE	1	
		TABLE	OFF	
		DISPLAY	MONO-GRAPH	

Figure 18-19 Switcher and Sweep Panels for Gap Scatter

GRAPH is chosen. If DISPLAY TABLE is selected, the response measurements will be tabulated in the second column and the selected track number will be shown in the third. One pair of limit files for the permissible upper and lower limits of frequency response will be applied to all 24 tracks. Any outside-limits measurements will be written into the error file, with the frequency, amplitude measurement, and track number (switcher channel number) printed along with the value of limit which was exceeded. An example is shown in Figure 18-15 of such an error file from the frequency response test, where channels 2, 13, and 17 failed the +/-2.0 dB upper or lower limits.

The panel for THD+N versus amplitude at a fixed frequency (MOL) is shown as Figure 18-16. The switchers will select the input and output of track 1 and an amplitude sweep from -10 dBu to +20 dBu will be made at the frequency set on the generator panel (typically 1 kHz). Measured THD+N will be plotted, though 3rd harmonic could

also be selected with the appropriate option filter. The switchers will step to track 2 and the MOL sweep will be repeated, etc.

For THD+N as a function of frequency, the panel is set up as shown in Figure 18-17. The switchers start on track 1 and THD+N is measured versus frequency from 10 kHz to 20 Hz. The switchers step to track 2 and the sweep repeats, etc.

For a spectral distribution of noise of each track, obtained by sweeping the one-third octave bandpass filter, the panel will be as shown in Figure 18-18.

The switchers select track 1; the generator output being set to OFF provides a back-termination of the selected track input. The analyzer bandpass filter center frequency is swept from 20 kHz to 20 Hz, the switchers step to track 2 and the filter sweep repeats, etc. The result is a display of the spectral distribution of noise of each track, all overlaid on the same graph or displayed as 24 successive sets of data in DISPLAY TABLE mode.

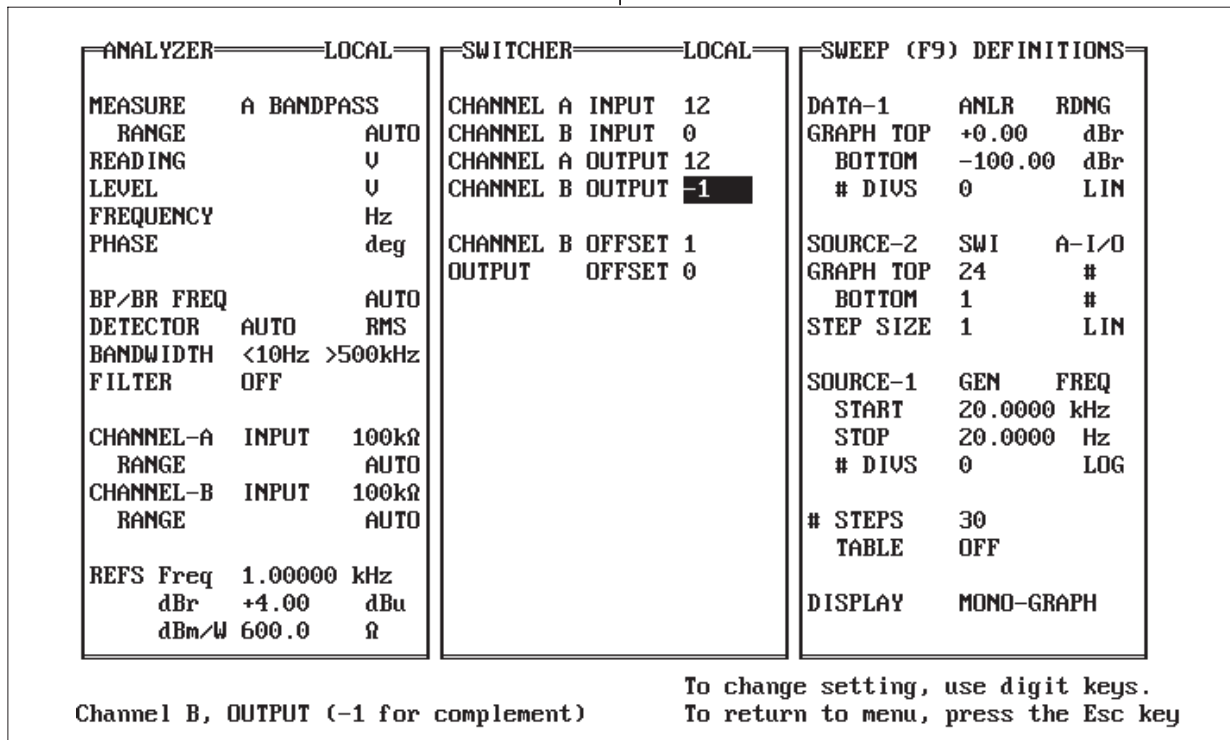

Figure 18-20 Analyzer, Switcher, and Sweep Panels for Worst-Case Crosstalk

For the gap scatter test, where track 12 will be used as the phase reference channel and all channels measured with respect to track 12, the SWITCHER panel will be set up as shown in Figure 18-19.

As a high frequency reference tape is played, the input switcher scans the analyzer A input across all 24 tracks. At each track, phase is measured with respect to track 12 which remains connected to the analyzer B channel input via the SWITCHER panel since the B input is not scanned.

For the worst-case crosstalk test, the switcher and sweep panels will be set as shown in Figure 18-20.

Selection of the complement mode (CHANNEL B OUTPUT set to -1) means that all output switcher channels will be turned on except for the one specified as CHANNEL A. The A channel selection is scanned from track 1 to track 24 as the SOURCE-2 parameter of the SWEEP (F9) DEFINITIONS panel. Thus, when the test begins, the output switchers will connect the generator A channel output to all tracks except track 1 while the input switcher connects track 1 into the analyzer. The generator

then sweeps from 20 kHz to 20 Hz while the analyzer (in BANDPASS mode to permit measurement of crosstalk below wide-band noise level) measures crosstalk from all other tracks into track 1. The switchers then step so as to drive all tracks except track 2 while measuring track 2 output, and the sweep repeats. The end result is measurement of crosstalk across the entire audio spectrum from all tracks into all tracks, in one test with one limit file.

18.5.3. Audio Chain or Mixing Console Channel

The patch-point switcher SWR-122P (or terminal strip version SWR-122T with jumpers and switches set to configure it as a patch point switcher) is designed for insertion at a number of points in an audio chain. Examples include the patch points in a mixing console input channel, or at the connections between the output of one piece of equipment and the input of the following one in a recording studio, broadcast station, or sound reinforcement installation. Figure 18-21 shows how two patch-point switchers might be installed at a stereo broadcast sta-

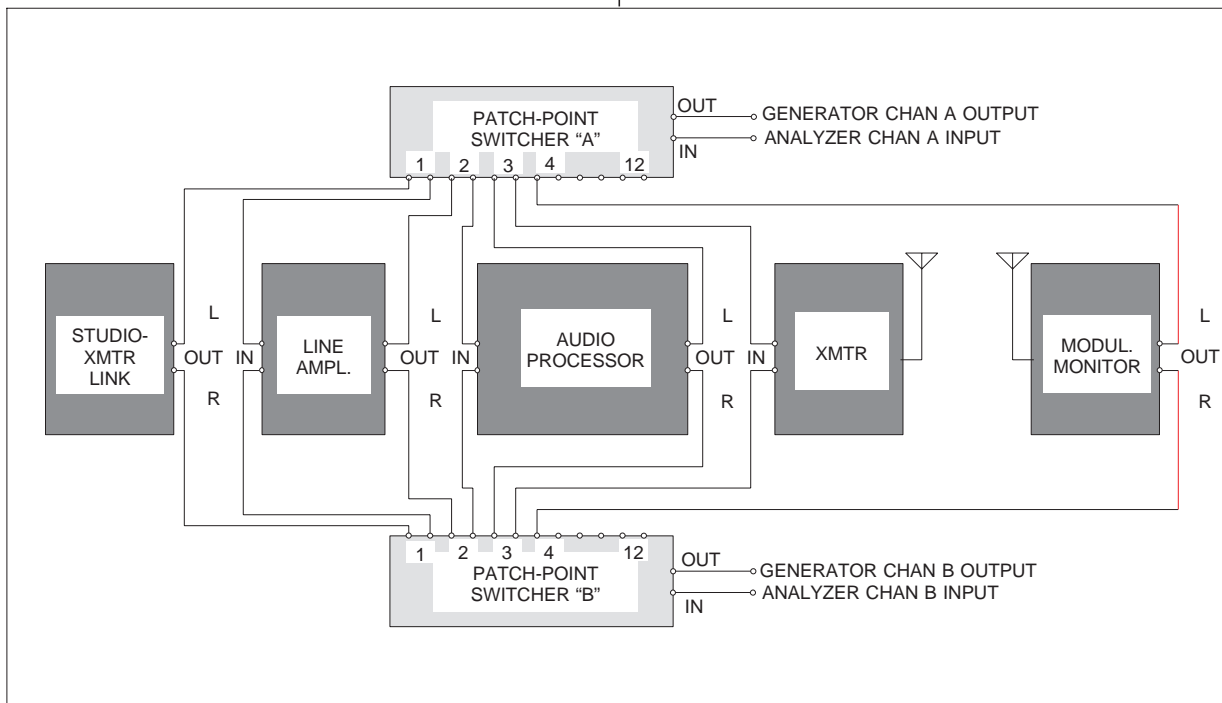

Figure 18-21 Patch Point Switcher in Audio Chain

tion at the studio-transmitter link output, line amplifier (if present) input and output, processor input and output, transmitter input, and modulation monitor output. All connections are balanced, but are shown as single connections in the figure for the sake of simplicity. If it is not necessary to do stereo tests such as phase, a single patch-point switcher could be installed to monitor and control both channels of a stereo system. With a single switcher, however, only one channel could have a normalled-through connection broken at any time.

The patch point switcher will normally be controlled from the SWITCHER panel, rather than in a scanning fashion from the SWEEP (F9) DEFINITIONS panel. Assume that the patch point switchers are installed as shown above, with the switcher installed in the left channel designated (by rear panel switches) as the A channel switcher, and the right channel switcher designated as B. With the SWITCHER panel set as shown below, all normalled-through connections are made and no signal monitoring takes place:

CHANNEL A INPUT 0

CHANNEL B INPUT 0

CHANNEL A OUTPUT 0

CHANNEL B OUTPUT 0

To monitor the signal at the processor output-transmitter input point in both channels, select

CHANNEL A INPUT 3

CHANNEL B INPUT 3

CHANNEL A OUTPUT 0

CHANNEL B OUTPUT 0

Normal signal flow will continue and the analyzer, by selecting A or B input on the ANALYZER panel, can measure signal in either the left or right channel.

To break the connection between the right channel line amplifier output and processor input while measuring line amplifier output signal on both channels, select

CHANNEL A INPUT 2

CHANNEL B INPUT 2

CHANNEL A OUTPUT 0

CHANNEL B OUTPUT 2

Selecting 2 as the CHANNEL B OUTPUT breaks the circuit, meaning that the level at B INPUT is now the unloaded output of the right channel line amplifier. The left channel line amplifier is still loaded by the left processor input. If the generator B OUTPUT is turned on, the generator will feed the right channel processor input. It is thus possible to proceed through both stereo channels, measuring signal with normal loading, breaking a connection to measure unloaded signal level, and driving the generator into the following input as desired.



19. DIGITAL SIGNAL PROCESSOR

Digital Signal Processor modules may be installed in the lower left-hand compartment of System One, underneath the generator. When the DSP modules are installed, System One becomes an SYS-200 series or SYS-300 series. The SYS-200 series is capable of a number of enhanced measurements of analog domain signals, including waveform display, spectrum analysis via FFT, highly selective amplitude measurements by use of digitally-implemented narrow-band filters, extremely rapid audio testing with multi-tone signals (FASTest), and quasi-anechoic loudspeaker testing by the MLS technique. The SYS-300 also performs these measurements and is further distinguished by its ability to measure and/or stimulate digital audio devices in the digital domain, in both parallel and the AES/EBU and SPDIF serial formats, and to perform bit error rate testing. This capability, added to the existing System One capability for audio signal generation and

measurement in the analog domain, allows the SYS-300 models to test analog and digital audio devices in any of the four possible combinations; A/A, A/D, D/A, or D/D.

The Digital Signal Processor modules include two or three DSP chips, memory, A/D and D/A converters, and supporting circuitry. For the various types of enhanced measurements on signals in the analog domain, analog signals are converted into the digital domain by two 16-bit A/D converters. All remaining processing and measurement is then digital. The SYS-300 series can additionally acquire and generate digital audio signals in the AES/EBU and SPDIF serial formats at front panel connectors, parallel-format signals at ribbon connectors at the rear of the enclosure, or in a wide variety of other serial formats with the SIA-322 Serial Interface Adapter.

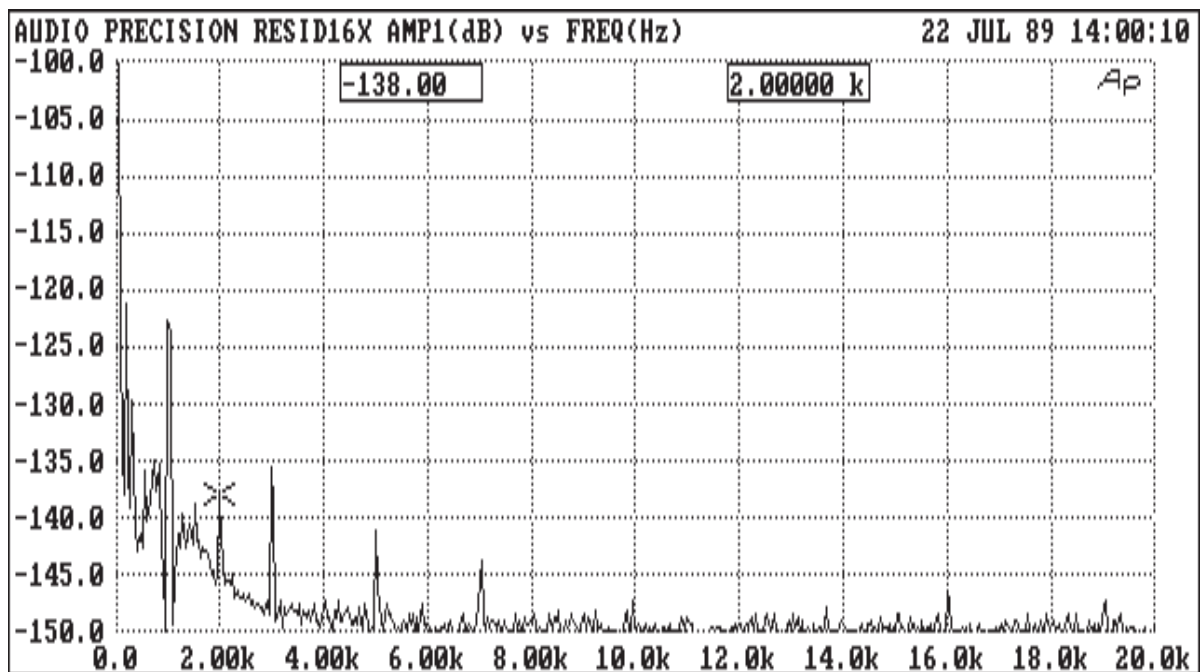

Figure 19-1 Residual Distortion of System One Analog Generator and Analyzer at 1 kHz; 8,192 Line FFT, 16x Averaged

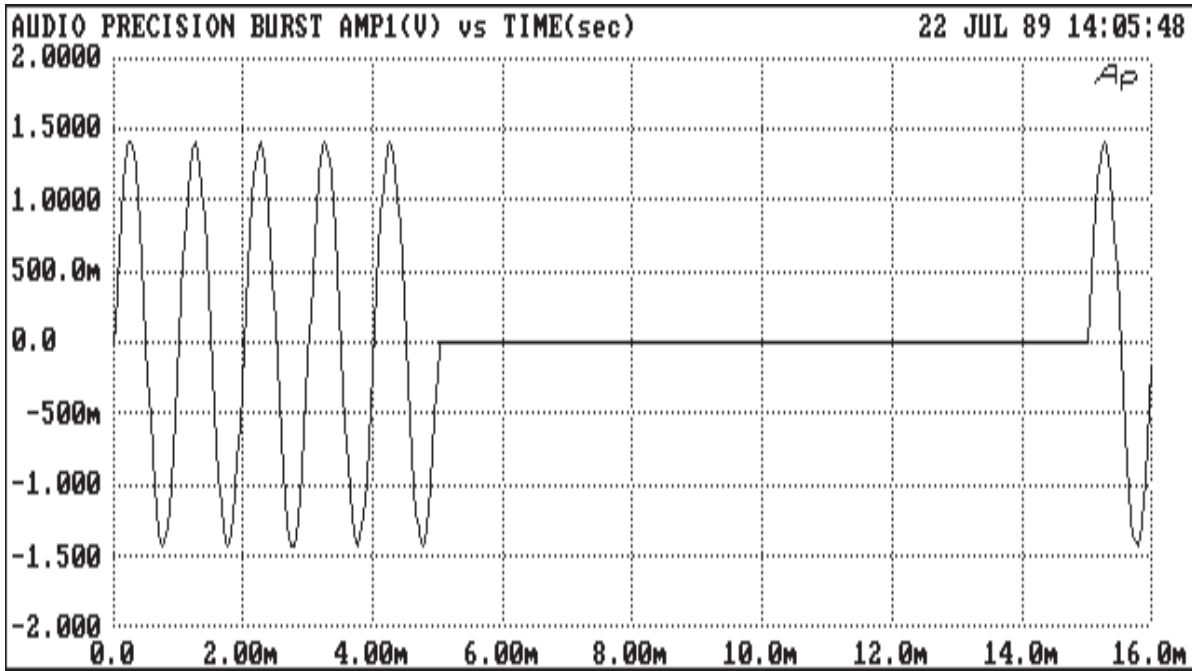

Figure 19-2 Burst Waveform from System One Generator, Acquired and Displayed by DSP

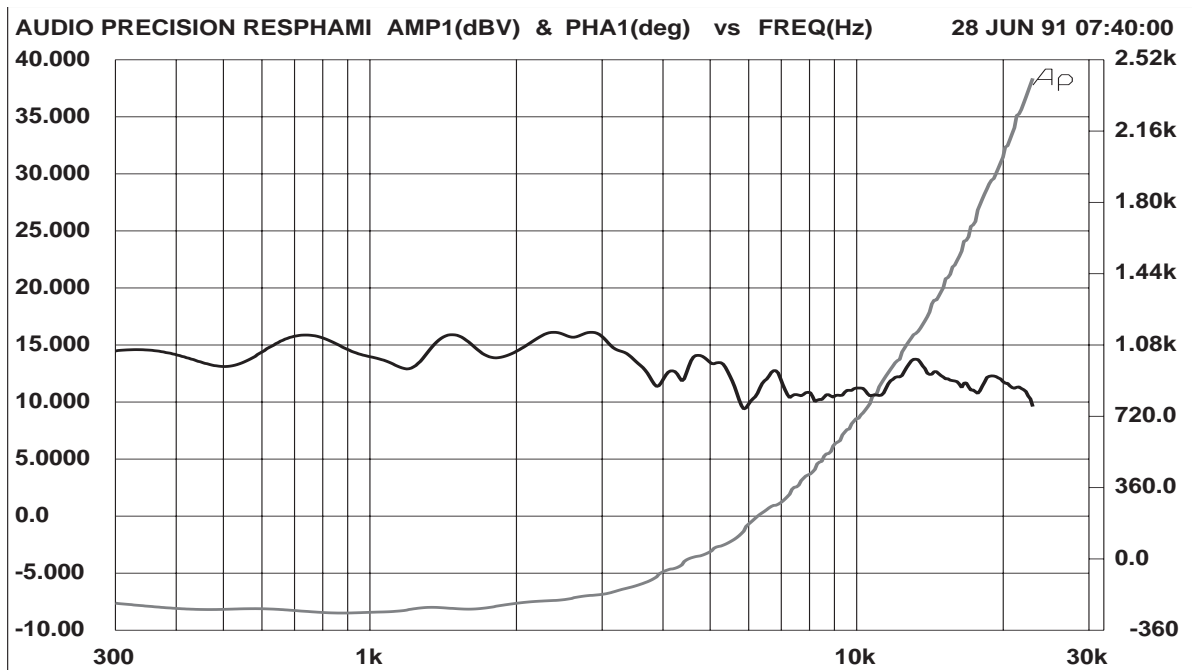

Figure 19-3 Anechoic Frequency and Phase Response of 3-Way Loudspeaker System

19.1. Typical DSP Applications

Figure 19-1 is a high-resolution spectrum analysis via FFT (Fast Fourier Transform) program of the residual distortion of a System One generator and analyzer at 1 kHz. The fundamental signal, attenuated by the analog notch filter, is visible at -122 dB. Several harmonics are visible in the -135 to -145 dB area, plus the noise floor at about -150 dB. The display is the averaged result of 16 acquisitions and FFT transforms.

Figure 19-2 is an example of the waveform display function possible with the FFT programs. The signal is the SINE BURST mode available from System One's BUR-GEN option.

Figure 19-3 shows the quasi-anechoic frequency response and phase of a three-way loudspeaker system as measured with the MLS (Maximum Length Sequence) technique. All room reflections were excluded from this measurement by selecting only the

portion of impulse response before arrival of the first reflection. This measurement requires less than five seconds.

Figure 19-4 shows total distortion (harmonic and intermodulation) and noise of an audio device. This measurement plus frequency response, inter-channel phase (if a stereo device), and several other audio parameters can all be measured in 2-4 seconds total with only 1-2 seconds of multi-tone stimulus signal required. Thus, broadcasting systems can be measured during normal programming, perhaps with the multi-tone signal serving as a time signal. In high-volume production test applications, the last device can be disconnected and the next device connected during the 2-3 seconds of additional analysis which takes place following the 1-2 seconds of stimulus.

Figure 19-5 shows THD+N versus frequency for a 16-bit PCM digital recorder, measured in each of these possible combinations of domain. The D/D curve at -98 dB demonstrates in practical measurement the theoretical quantization noise and distortion value of a 16-bit PCM system. The D/A curve

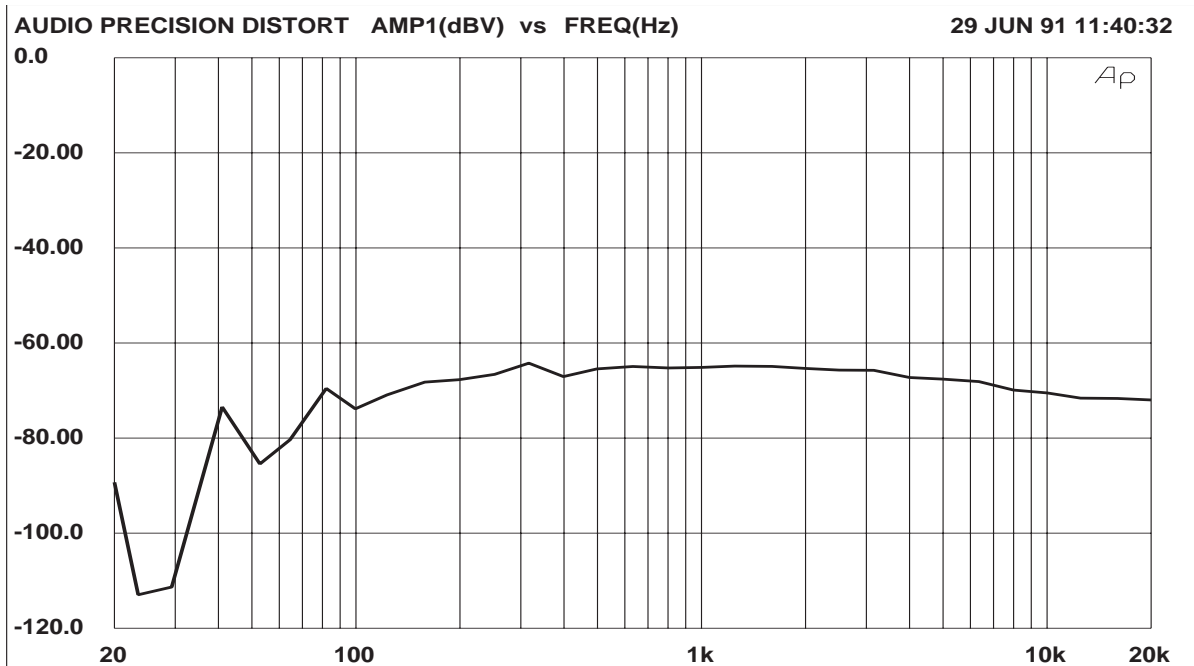

Figure 19-4 Total Distortion and Noise vs Frequency, Measured Along with Response, Phase, Noise, and Crosstalk from Multi-Tone Stimulus of Less Than Two Seconds.

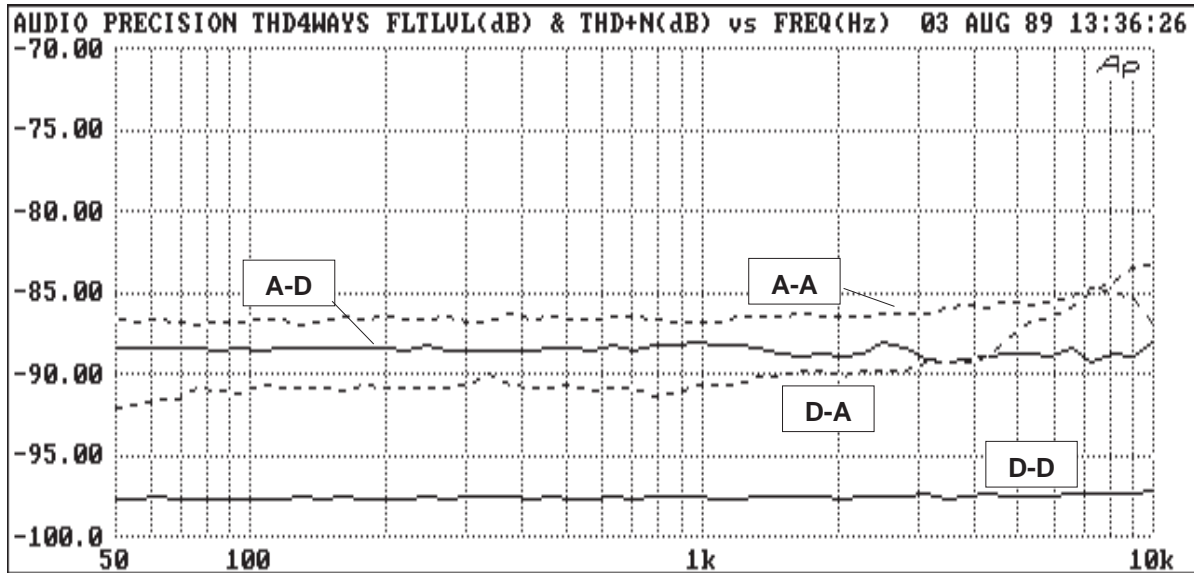

Figure 19-5 RDAT THD+N vs Frequency In All Combinations of Analog and Digital Inputs and Outputs

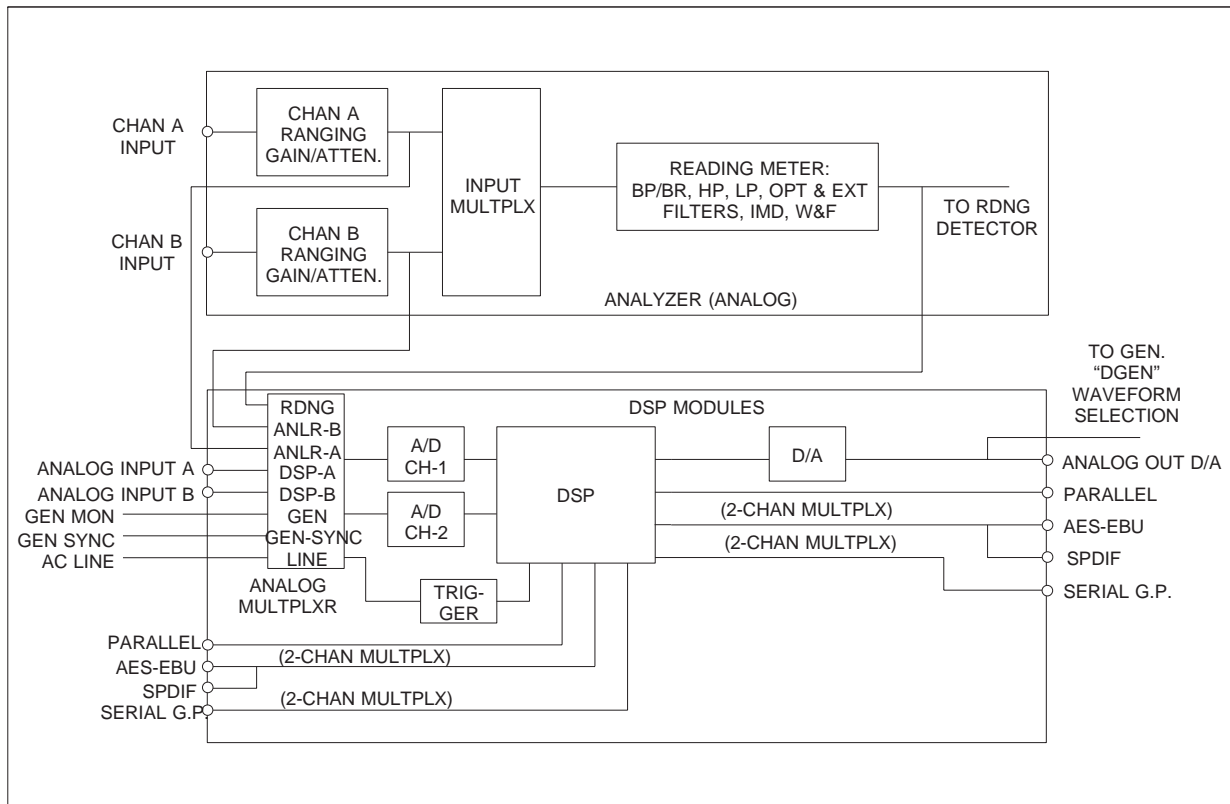

Figure 19-6 Simplified Block Diagram, DSP Inputs and Outputs

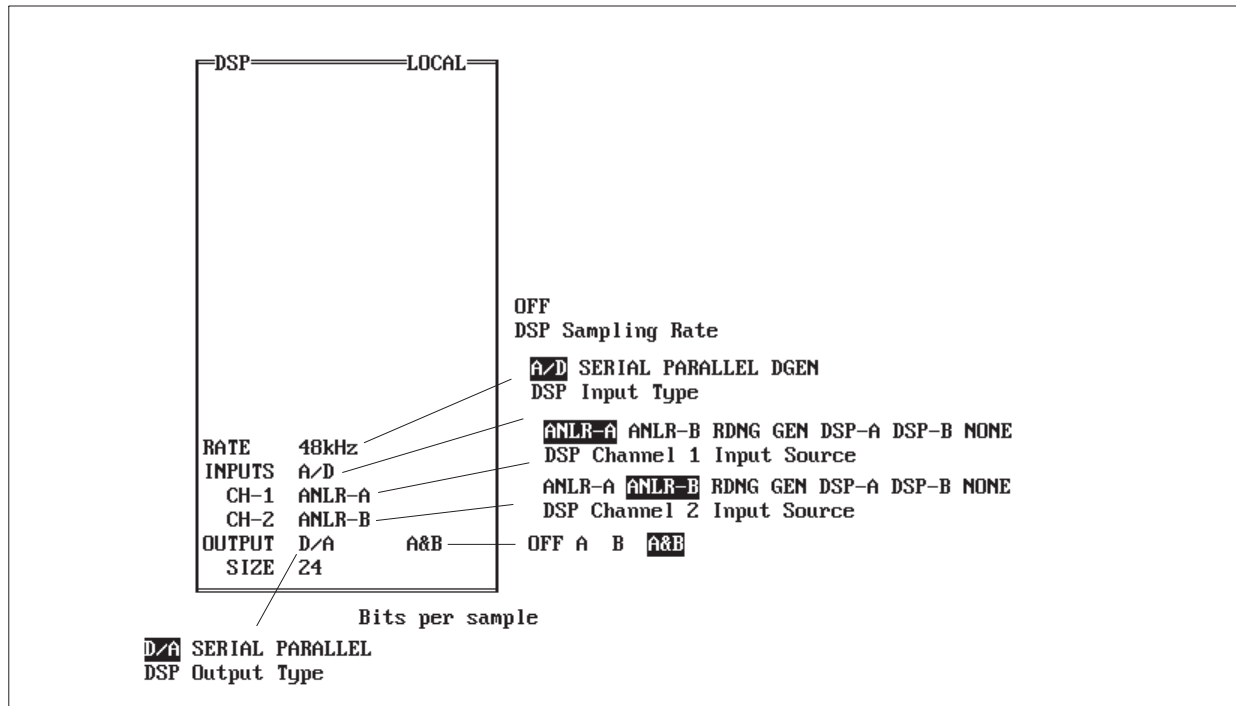

Figure 19-7 DSP Panel With No DSP Program Loaded

shows the recorder’s output DAC adding about 6 dB distortion above theoretical minimum. The A/D and A/A curves show the recorder’s input A/D converter to be the dominant source of distortion, adding some 10-12 dB above theoretical minima.

19.2. DSP Architecture

The Digital Signal Processor modules include two or three DSP chips, memory, 16-bit A/D and D/A converters, and supporting circuitry. For the various types of enhanced measurements on signals in the analog domain, analog signals are converted into the digital domain by two A/D converters. All remaining processing and measurement is then digital. The points at which the analog signal may be acquired include (in effect) the CHANNEL A, CHANNEL B, and READING monitor connectors of the analyzer, the MONITOR connector of the generator, and two additional BNC input connectors dedicated to the DSP.

The SYS-300 series additionally acquires and generates 24-bit digital audio signals in the AES/EBU and SPDIF (coaxial and optical) serial formats at front panel connectors, and general-purpose serial and parallel-format signals at the rear of the enclosure. See Figure 19-6 for a simplified block diagram of the signal connections to and from the DSP modules. An accessory device, the SIA-322 Serial Interface Adaptor, supports easy connection of System One Dual Domain to a wide variety of non-standard serial interfaces.

19.3. Downloading DSP Programs

As a special-purpose digital computer, the DSP module requires programs to tell it what to do. These files (identified by the file extension .DSP) are downloaded from the personal computer to the DSP modules within System One by the NAMES PROGRAM command. If a .TST file is loaded to which a DSP program had previously been attached via the NAMES PROGRAM command, the DSP

program automatically downloads when the .TST file is loaded into memory (unless that same DSP program is already there from the previous test).

The DSP panel is reproduced in Figure 19-7. Until a DSP program is downloaded to the DSP module, most of the panel is blank. The control and display fields which load into the DSP panel depend upon which program is downloaded. Only the fields at the bottom of the panel are common to all DSP programs. These fixed fields permit selection of the sample rate at which the input data is acquired, whether the input is analog or digital, and what signal drives each input. If a generator capability is included in the DSP program, these fields will select the destination of the internally-generated signal and its sample rate. The HELP DSP menu selection presents a screen of information which is also loaded by each .DSP program selected.

19.4. DSP Input Operation

19.4.1. Rate vs Bandwidth

The RATE choices available in the hardware are 1 kHz, 8 kHz, 32 kHz, 44.1 kHz, 48 kHz, 176.4 kHz, and 192 kHz. Not all rates are available in all .DSP programs. The digital input and/or output capability functions only with the 32 kHz, 44.1 kHz, and 48 kHz rates. The remaining rates, if available in a particular program, function only as effective sampling rates of the A/D converters for acquiring analog signals.

The bandwidth available with any rate cannot exceed half the sample rate, as originally shown by Nyquist. In practice, the useful bandwidth is somewhat less than half the sample rate. System One's DSP module, when acquiring analog signals, actually functions with the A/D converters always operating at a 192 kHz or 176.4 kHz sample rate and with an anti-alias low-pass filter bandwidth from zero to 80 kHz. When a lower sample rate is se-

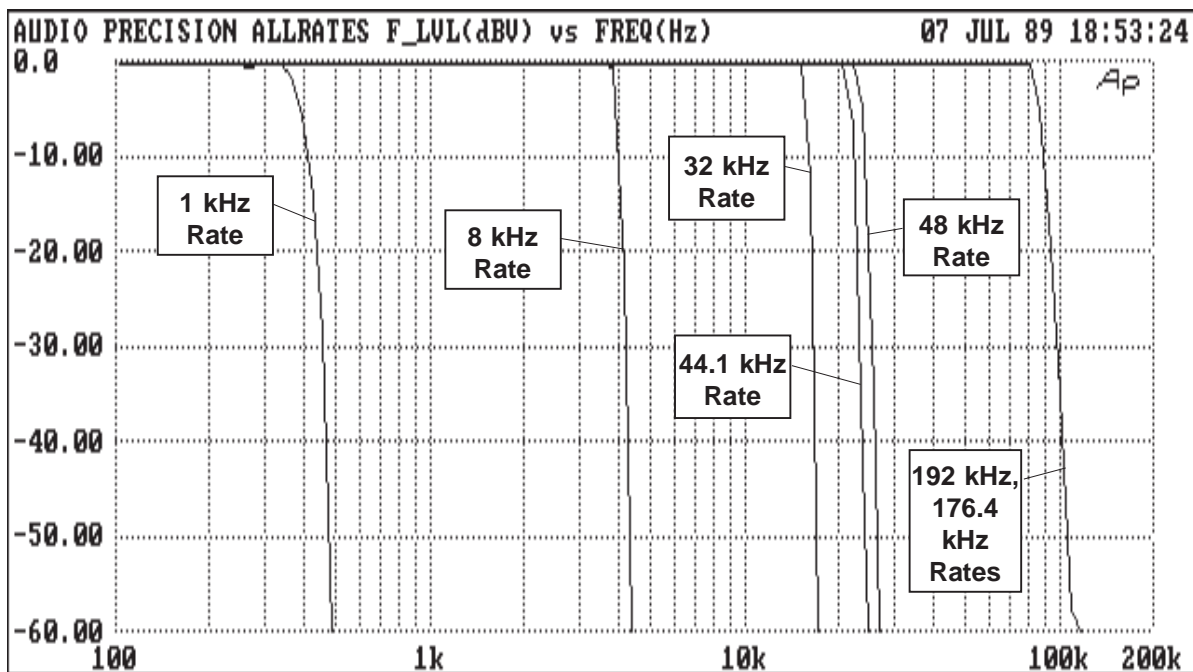

Figure 19-8 Frequency Response vs Sampling Rate, DSP

lected, a second DSP chip functions as a decimator, effectively scaling down both the sample rate and the anti-alias filter corner frequency to lower values. Figure 19-8 shows the typical measured frequency response of the analog input channels at each sample rate. Typical -3 dB points are 375 Hz at the 1 kHz rate, 3.94 kHz at the 8 kHz rate, 15.7 kHz at the 32 kHz rate, 21.6 kHz at the 44.1 kHz rate, 23.5 kHz at the 48 kHz rate, and 85.3 kHz at the 176.4 and 192 kHz rates. Linear phase acquisition of analog signals is only available at sample rates of 48 kHz and lower. The 1 kHz sample rate is intended only for acquisition and spectral analysis of very low frequency signals such as wow and flutter.

19.4.2. Dither

Dither is noise combined with the signal to improve linearity, reduce distortion at low amplitudes, and extend the linear operating range below the theoretical minimum for undithered PCM signals of any particular resolution. Both rectangular and triangular probability function dither with flat noise spectra are selectable, plus triangular probability function with a spectrally-shaped frequency distribution to reduce the audibility of the dither.

19.4.3. AES/EBU Status Bytes

The AES/EBU digital audio transmission standard (AES3-1985, also ANSI S4.40-1985) reserves 24 8-bit status bytes in addition to two channels of digitized audio signals. The UTIL AES-EBU RECEIVE and UTIL AES-EBU TRANSMIT menu commands permit control over the status bytes transmitted at the AES output connector of Dual Domain (SYS-300 family) units, and display of the bytes received at the AES input connector.

For specific information on the use of each DSP program, see the DSP program documentation which is furnished with each DSP program.



20. BURST-SQUAREWAVE-NOISE GENERATOR

20.1. Tone Burst Waveforms

The tone burst capability of the BUR-GEN module provides sinewave bursts which switch between normal amplitude and a lower amplitude. Switching between the higher and lower levels always occurs at a positive-going zero crossing. The duration and repetition rate of the burst are controllable, as is the lower amplitude. The sinewave is produced by the generator oscillator. Thus, its frequency is determined by the FREQUENCY field on the GENERATOR panel and the higher amplitude is at the calibrated AMPLITUDE value on the GENERATOR panel. In addition to the free-running, repetitive mode of SINE BURST, bursts may be either externally triggered (SINE TRIG) or the signal may be gated on and off (SINE GATE) by an external sig-

	GENERATOR	LOCAL
WAVEFORM	SINE	BURST
FREQUENCY	1.00000 kHz	FAST
AMPLITUDE	1.000	V _{rms}
BURST ON	20.00	CYCL
INTERVAL	500.0	CYCL
LOW LVL	-20.00	dB

Figure 20-1 Burst Control Areas, GEN1 Panel

nal. The tone burst parameters may be swept as a SOURCE-1 or SOURCE-2 independent variable during a sweep test.

Figure 20-1 shows the burst control area of the GENERATOR panel. All three of these lines will be visible only when BURST mode is selected on the WAVEFORM line. Only the BURST ON and LOW LVL lines will be displayed when TRIG is selected, and only the LOW LVL line will be displayed when GATE is selected. See Figure 20-22 for a graphic explanation on these parameters, which are explained below.

The maximum burst ON time is 65,535 cycles of sinewave. The burst ON time may be set in any of three units.

- **CYCLES** is the basic unit, and refers to integral cycles of the sinewave being generated.
- The **secB** (seconds of burst) unit causes a computation (using the sinewave period) from time to cycles, with a round-off to the nearest integral cycle. For example, if the generator GENERATOR panel FREQUENCY is 1.00 kHz (1 millisecond period) and 3.7 msecB is entered for BURST ON, the software will round off to the nearest integral number of cycles and produce a 4-cycle burst. The panel indication will also show 4.0 msecB, the actual value produced, rather than the 3.7 msecB entered by the user. Each time the generator frequency is changed (panel, bargraph, or sweep mode), a new computation and round-off to the nearest integer number of cycles will take place.
- **%ON** is also a computed unit, interacting with the burst interval (and the sinewave period when necessary) to produce a burst of the stated duty factor. For example, if the INTERVAL is 500 CYCLES, and 50% is entered as %ON, a burst of 250 cycles will result. If the INTERVAL were set as 250 msecB and the

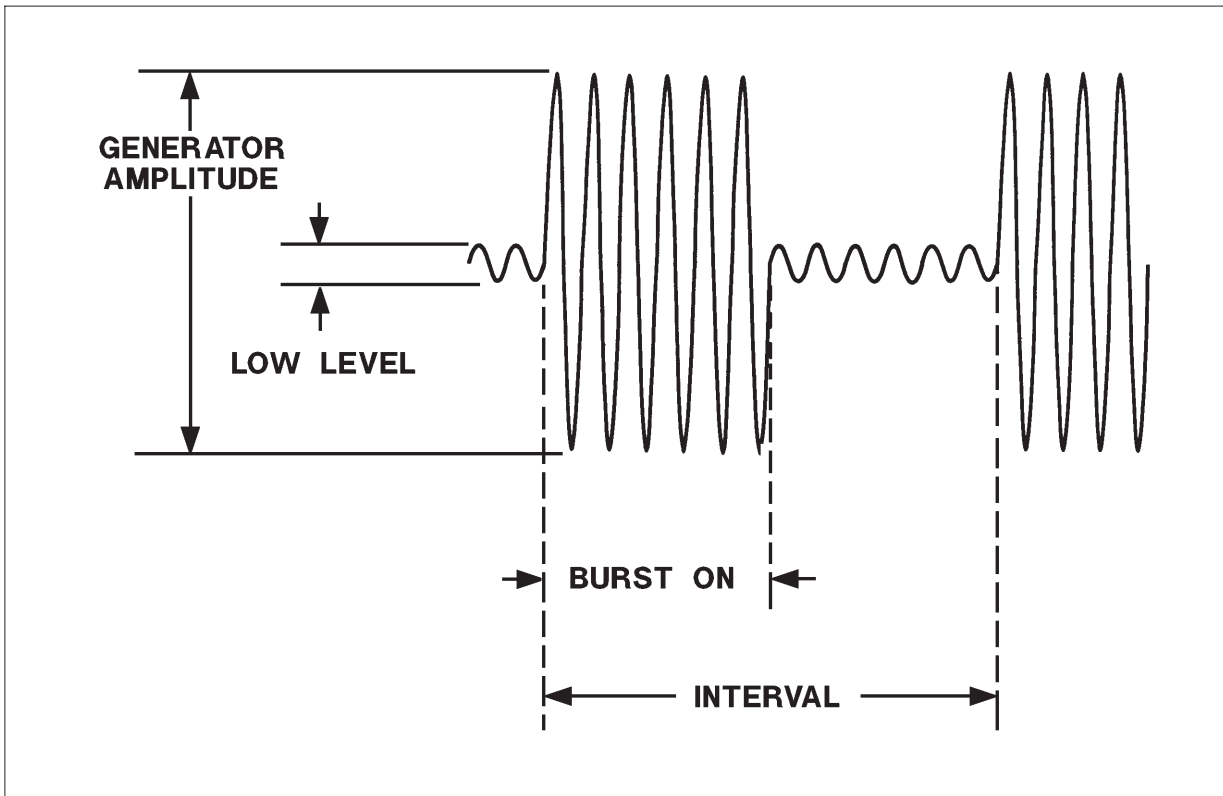

Figure 20-2 Burst Amplitude and Time Calibration

generator frequency were 1.00 kHz, computations will be made from time to cycles to time; a burst on time of 125 milliseconds would result from the 50% ON selection. If the INTERVAL were set as 3 Bps (bursts per second), the software will calculate the interval in cycles using the generator frequency, then compute the number of “on” cycles closest to the selected duty factor. With a 1.00 kHz frequency, the 3 Bps rate will actually produce a 333 cycle interval (the actual displayed Bps value will be 3.003). The 50% ON selection (theoretically 166.5 cycles) will then be rounded to 167 cycles which will be displayed as 50.15% ON.

The maximum burst INTERVAL is 65,536 cycles of sinewave. The burst INTERVAL may also be controlled in any of three units. Interval is the time from the beginning of one burst to the beginning of the next burst, not the time between the end of one burst and the beginning of the next.

- **CYCLES** is the basic unit, and refers to integral cycles of the sinewave being generated by generator.
- **secB** (seconds of burst interval) is computed, using the period of the sinewave, with a roundoff to the nearest integral number of cycles. The displayed time will be the nearest legal value after rounding, rather than the entered value.
- **Bps** is bursts per second. It is computed using the period of the sinewave and rounding to the nearest integral number of cycles. The nearest legal value will be displayed.

Burst ON and INTERVAL values may be typed into their control fields from the keyboard. These values may also be incremented and decremented the the <+> and keys when the cursor is placed on the field. The increment size is always one unit; one cycle in CYCL units, one percent in %ON, one second in time units, etc. If TB-ON or

TB-INT is selected at SOURCE-1 and bargraph (<F2>) display selected, the increment and decrement features will also function on the bargraph.

The **LOW LVL** (low level) line controls the amplitude of the generator output between bursts. This is set relative to the amplitude during bursts determined by the generator **AMPLITUDE** field. In triggered and gated mode, the generator output will be at the **LOW LVL** amplitude between triggered bursts or gated-on portions. The **LOW LVL** amplitude may be set in any of three units.

- **%** The % unit states the lower level amplitude as a percentage of the voltage of the upper amplitude.
- **dB** The dB unit states the lower level amplitude in dB below the upper amplitude.

- **X/Y** The X/Y unit states the ratio of the lower level amplitude to the upper level amplitude.

The lower level amplitude may equal the upper level amplitude, in which case no burst, gated, or triggered effect will be visible. At large amplitude ratios, the amplitude resolution of the lower level will become poorer. The display will show the actual available resolution steps, rather than the entered value. The lower level is limited to -80 dB (0.01%).

20.1.1. Triggered Bursts

In triggered operation (SINE TRIG mode), one burst of the specified **BURST ON** duration will be generated for each trigger presented to the TRIG-

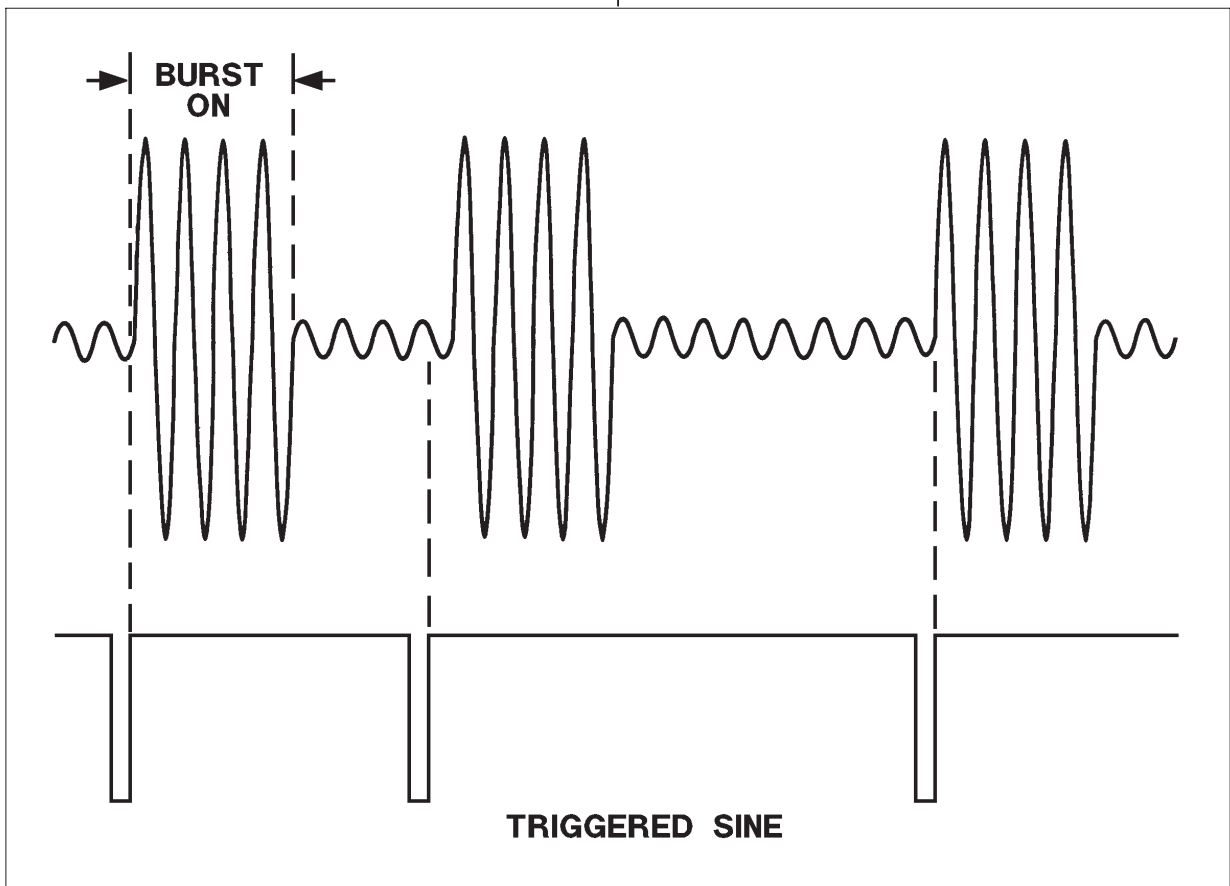

Figure 20-3 Timing Relationships, Triggered Bursts

GER/GATE input. This input is a BNC connector on the lower left front panel section of System One and is LSTTL compatible. In SINE TRIG mode, it is intended to be driven by a signal which is at a logic high level but pulses low for at least one microsecond to trigger a burst. See Figure 20-3 for the relationships between the trigger signal and the burst output. The burst will be triggered by the positive-going (trailing) edge of such a signal. If the TRIGGER/GATE input signal remains at the logic high level after triggering the burst and between bursts, the burst duration will be as set on the panel and the generator output amplitude will remain at the LOW LVL value until the next trigger. If the TRIGGER/GATE input drops to the low logic level during a burst, it will gate the signal off (terminate the burst prematurely) at the next positive-going zero crossing of the sinewave.

Bursts will always consist of an integral number of cycles, beginning and ending at positive-going zero crossings. Thus, there may be a delay of up to one sinewave period between the positive-going trig-

ger pulse at the external connector and the beginning of the burst. The INTERVAL line is blanked in TRIG mode, since the burst interval will be determined by the external trigger source.

20.1.2. Gated Sinewaves

Gated operation (SINE GATE mode) allows an external signal at the TRIGGER/GATE connector to control whether the generator output amplitude is at the upper (GENERATOR panel AMPLITUDE) value or the LOW LVL value. Positive, LSTTL-compatible logic conventions are used. Thus, the sinewave amplitude will be at the upper level when the input is high and at the LOW LVL when the input is low. When no external device is connected, the TRIGGER/GATE input is pulled high by an internal resistor and the generator output will be at the high level. The actual output gating always takes place at positive-going zero crossings, so there can be up to a one-period delay at both the gate-on and gate-off transitions. See Figure 20-4 for the timing

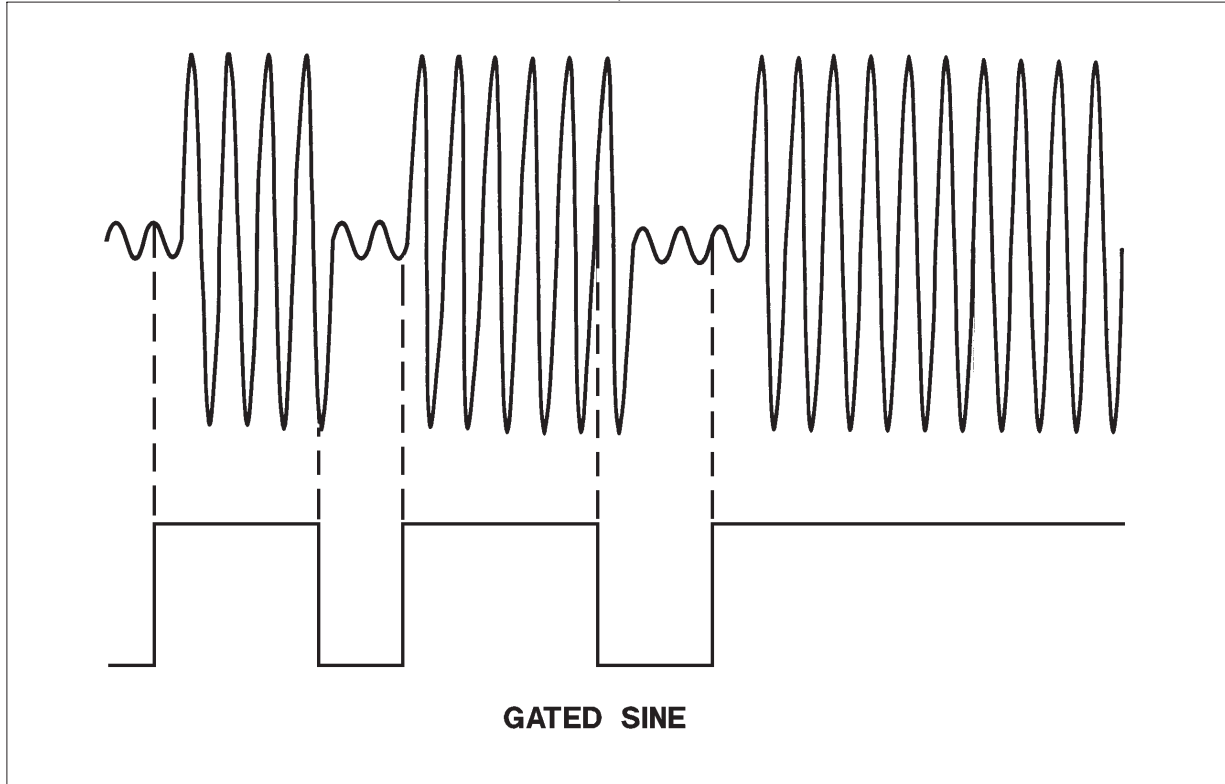

Figure 20-4 Timing Relationships, SINE GATE Mode

and logic relationships in SINE GATE mode. Both the BURST ON and the INTERVAL lines are blanked in GATE mode, since both these parameters are determined by the external gating signal.

Note that the TRIGGER/GATE input connector is functional in the SINE BURST, SINE GATE, AND SINE TRIG modes. If this control input is pulled to a logic low condition, it will gate the signal to the LOW LVL amplitude even during internally-controlled burst mode or during an externally-triggered burst.

20.2. Squarewaves

Selecting SQUARE on the WAVEFORM line will produce squarewaves from the generator output when the BUR-GEN module is installed. The squarewave is calibrated in peak equivalent sine-wave terms. Thus, selecting a squarewave with an AMPLITUDE value of 1.000 Vrms on the GENERATOR panel will produce a 2.828 V peak-to-peak signal. The maximum available amplitude of the squarewave is limited to half the amplitude selectable in sinewave mode. The frequency range for squarewaves is from 20 Hz to 20 kHz. Note that the BAL/UNBAL selection must match the external load. Connecting to an unbalanced load from the BAL output configuration will produce distorted squarewaves.

20.3. Noise Waveforms

Several varieties of noise waveforms are available from the BUR-GEN option. Both PSEUDO and RANDOM selections will produce noise waveforms.

20.3.1. Pseudo and Random Noise

The PSEUDO noise mode produces noise which is random during a 262 millisecond period, but which then repeats every 262 milliseconds. This repetition cycle synchronizes with the nominal 4/sec reading rate of the analyzer, producing stable displays. The RANDOM mode is truly random and

never repeats. Readings made using RANDOM mode will not be stable at any reading rate. The noise spectrum in the RANDOM mode will have energy at all frequencies within its specified bandwidth; that is, the spectral lines will be infinitesimally closely spaced. In PSEUDO noise mode, the spectral lines will be spaced at the repetition rate of the pseudorandom cycle, or approximately every 4 Hz from 4 Hz to the upper bandwidth limit. This signal may not be acceptable for certain applications, particularly at very low frequencies. However, if the measurement interval is limited, it does no good to have a noise signal which repeats less often.

Amplitude calibration in the PSEUDO noise mode is in terms of equivalent sinewave peak, as with other complex waveforms such as intermodulation test signals and squarewaves. The PSEUDO noise mode of the BUR-GEN has a crest factor (ratio of peak to rms) of 4:1 (12 dB). Since a sinewave has a crest factor of 1.414:1 (3 dB), the rms value of the PSEUDO noise waveform at any given AMPLITUDE setting will be 9 dB less than that of a sinewave at the same AMPLITUDE. In the RANDOM noise mode, amplitude calibration is to approximately the same rms value as in PSEUDO mode. The result is that in RANDOM noise mode, occasional noise peaks may exceed the peak-to-peak value of a sinewave of the same AMPLITUDE. While the theoretical crest factor in RANDOM mode is infinite, a 4:1 crest factor will be exceeded only 0.01% of the time. The maximum available AMPLITUDE setting in the noise modes is half that of the sinewave modes.

In either PSEUDO or RANDOM mode, additional selections of the noise spectral distribution may be made among WHITE, PINK, BPASS, and EQBPN.

20.3.2. White Noise

WHITE selects white noise mode. This mode is bandwidth limited to 22 kHz to maximize the noise energy falling within the audio band. The spectral distribution of white noise is characterized by equal noise energy per Hz of bandwidth. The spectral

range between 100 Hz and 200 Hz will thus have the same energy as the range between 10,000 Hz and 10,100 Hz. If analyzed by a constant bandwidth spectrum analyzer such as a superheterodyne or FFT analyzer, white noise will show a flat energy characteristic versus frequency (up to the bandwidth limitation). Analysis with a constant-percentage-bandwidth (constant Q) filter such as System One's bandpass mode or most real-time analyzers will show a rising characteristic versus frequency, at the rate of 3 dB per octave.

20.3.3. Pink Noise

PINK selects pink noise mode. Pink noise is characterized by equal noise energy per fractional octave, fractional decade, or equal percentage bandwidth. Thus, the octave of pink noise between 5 kHz and 10 kHz will contain the same energy as the octave between 300 Hz and 600 Hz. A constant-percentage-bandwidth analyzer such as System One's bandpass mode and most real-time audio analyzers will show a flat characteristic with frequency. A constant bandwidth spectrum analyzer such as a superheterodyne or FFT analyzer will display pink noise as having a fall-off with increasing frequency, at the rate of 3 dB per octave. The BUR-GEN's pink noise is generated by filtering the basic white noise source through a 3 dB per octave filter. Pink noise will sound subjectively flat to the ear because the sounds are perceived on a constant bandwidth basis. When checking response of devices such as multiway loudspeaker systems, pink noise will supply more equal levels to low, midrange, and high frequency drivers than will white noise.

20.3.4. Bandpass Noise

BPASS mode selects the pink noise mode, but further processes the noise by passing it through a 1/3 octave tunable bandpass filter whose center frequency is controlled by the FREQUENCY field of the GENERATOR panel. This filter is, in fact, the basic state-variable oscillator circuit of generator, used as a bandpass filter. The filter center frequency can thus be tuned from 10 Hz to 204 kHz. The center frequency can be controlled in Panel

mode from the GEN FREQUENCY field or by use of <+> and keys in conjunction with the FREQSTEP value, in bargraph mode by the arrow keys, mouse, or <+> and keys, and can be swept as GEN FREQ at either SOURCE-1 or SOURCE-2 on the sweep test definitions panel. Units may be Hz and kHz or any of the generator relative frequency units.

20.3.5. Equalized Bandpass Noise

EQBPN stands for equalized bandpass noise. EQBPN furnishes 1/3 octave bandpass-filtered pink noise, as described above under BPASS. EQBPN differs from BPASS in that, if an equalization file (xx.EQ) has been attached to the current test file by the NAMES GEN-EQ command and EQBPN mode is selected, the amplitude of the generator will be further modified by the value (interpolated if necessary) from the equalization file at the current frequency value. The narrowband noise vs frequency relationship can thus be made to follow any desired characteristic. The value after the equalization computation is displayed in the POST-EQ field of the GENERATOR panel. EQBPN mode is effective during Panel mode with numeric entry into the FREQUENCY field or by FREQSTEP control, in bargraph mode with mouse, arrow key, or <+> and control, and in swept operation of System One. See the EQUALIZATION chapter of this manual for more details on how to create, modify, and attach xx.EQ files to tests.

20.3.6. USASI Noise

A specific spectral distribution of noise has been defined by the United States of America Standards Institute (USASI). This noise distribution consists of white noise filtered to peak at approximately 200 Hz, with 6 dB per octave falloff below 100 Hz and above 320 Hz. This shape was chosen to simulate long-term average spectra of typical audio program material.

USASI noise can be generated by the BUR-GEN module by loading an overlay called USASI.OVL from the Tests and Utilities diskette. This overlay

file may be loaded onto a test file which has already set up the desired amplitude, output configuration, etc. The generator conditions may also be changed as desired for the specific application after loading the overlay. Since these parameters are blanked in the .OVL file, <Alt>R (restore) may be used to make them visible after the file is loaded.

USASI noise pulsed between two amplitudes can even more fully simulate program material. Pulsing USASI noise at a 2.5 Hz repetition rate with a 12.5% duty cycle with a LOW LVL of -20 dB has been selected as a standard test signal. This signal is used, along with RF spectrum analyzer measurements, to determine the occupied bandwidth of broadcast stations while signal processing devices and filters are adjusted. To obtain this pulsed USASI noise, load the overlay B_USASI.OVL from the Tests and Utilities diskette and make any additional adjustments required.



21. DCX-127 DC AND DIGITAL I/O MODULE

The DCX-127 is a versatile dc and digital input-output device for use with System One or independently. It measures dc voltage and resistance and acquires a parallel digital input word of up to 21 bits plus sign. It provides two controllable dc voltage outputs in the range between (10.5000 Volts, and a digital output word of 21 bits plus sign. The DCX-127 also features three rear-panel 8-bit output ports for control of external logic or relays, a front-panel program control output connector with a number of signals synchronized with sweeps and tests, and a front-panel program control input to support custom, limited-function keyboards. The front panel of the DCX-127 is normally located at the center of the second page of System One screens, obtained from the menu by the <Esc> <P> <PgDn> keystroke sequence. The DCX-127 software control panel is reproduced as Figure 21-1.

21.1. Voltage and Resistance Measurements

The DCX-127 includes a 4 1/2 digit autoranging dc voltmeter-ohmmeter. Measurements are displayed digitally on the DCX panel, on the DMM line; on monitors with intensity control, these digits will be brighter. The voltage or resistance measurements may also be selected as DATA-1 or DATA-2 values on the SWEEP (F9) DEFINITIONS panel. Thus measurements can become lines on a graph, columns in a tabular data display, or viewed in analog fashion in bargraph <F2> mode. As with any other System One measurement, limits files for dc voltage or resistance may be created and connected to a test, with measurements then compared to the limits. See the ACCEPTANCE TEST LIMITS chapter for more details.

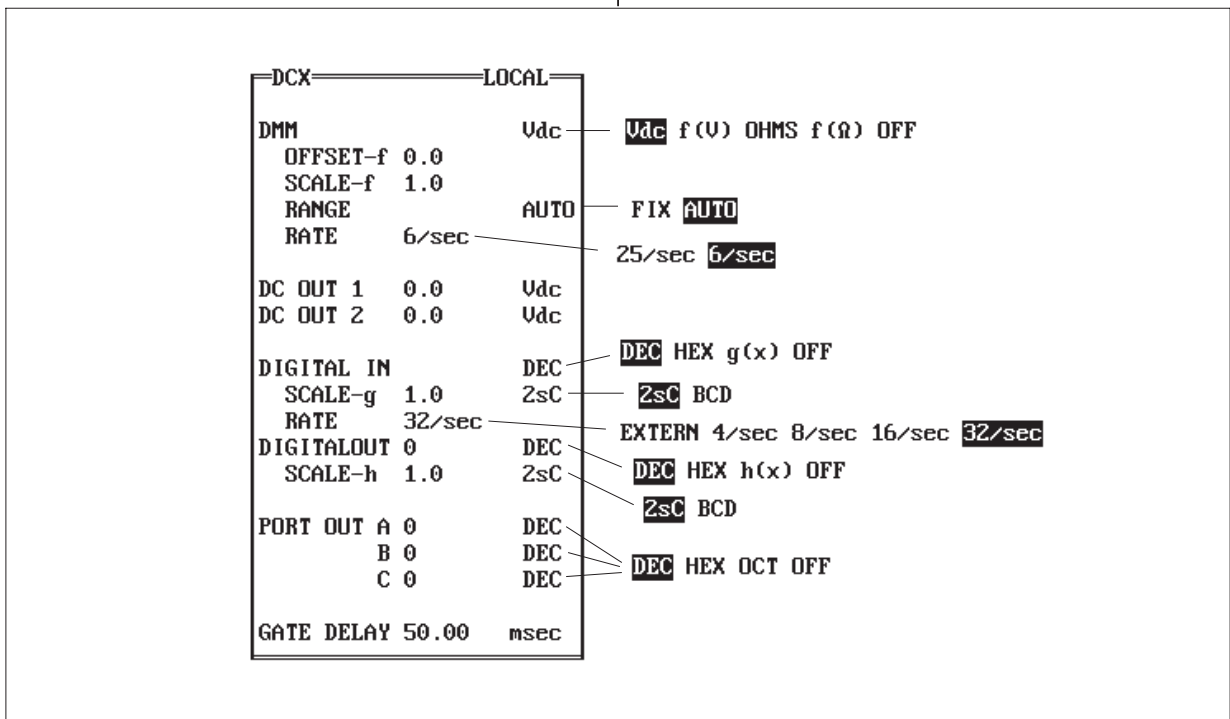

Figure 21-1 DCX-127 Control Panel

RANGE	RESOLUTION 6/sec RATE	RESOLUTION 25/sec RATE
200 mV	10 uV	50 uV
2 V	100 uV	500 uV
20 V	1 mV	5 mV
200 V	10 mV	50 mV
500 V	100 mV	500 mV

Figure 21-2 Range & Resolution vs Rate

21.1.1. Dc Voltage Measurements

Dc voltage mode is selected by either the Vdc or f(V) selections on the DMM (digital multi-meter) line of the DCX panel. Vdc provides a direct readout in voltage; f(V) further processes the measurement with the offset and scale factors on the next two lines before display.

In voltage mode, the meter will automatically select among its 200 mV, 2 V, 20 V, 200 V, or 500 V ranges for best resolution of the measured signal. Resolution versus range and reading rate are shown in Figure 21-2.

If autoranging is not desired, the AUTO field may be changed to FIX. The adjacent field will then display the currently-selected range. Another range may be selected by typing in the highest expected reading; the system will automatically select the compatible range.

Reading rates of 6/second or 25/second are selectable on the RATE line. The 6/second selection provides the full 4 1/2 digit resolution (20000 counts full scale). The 25/second selection will still display 4 1/2 digits, but the last digit will always be either a 0 or a 5. Normal and common mode rejection will also degrade by approximately a factor of four when the 25/second reading rate is selected.

21.1.2. Resistance Measurements

The DCX-127 DMM also functions as a resistance-measuring device by selecting the OHMS or f(Ω) functions on the DMM line. OHMS provides direct readout of resistance in Ohms, while f(Ω) is a computed value using the offset and scale parameters underneath the DMM line.

The resistance mode operates by forcing a calibrated value of current through the unknown resistance and measuring the consequent voltage drop.

The DCX-127 input configuration permits making these resistance measurements on either a 2-wire or 4-wire basis. If only one pair of test leads is used, connected from the (+) and (-) terminals of the DCX-127 to the unknown resistance, a 2-wire measurement results. Current from the internal current source flows through a internal resistor, the test leads and resistance being measured, and another internal resistor back to the current source. The two internal resistors are indicated schematically on the front panel of the DCX-127. Voltage drop produced by this current is internally measured at the (+) and (-) terminals. The resistance of the two test leads is thus included in the measurement. For moderate and high values of unknown resistance, the additional error introduced by resistance of the test leads is usually negligible.

For the highest accuracy when measuring low values of resistance, a 4-wire measurement (Kelvin lead connection) is recommended. For this measurement, one pair of test leads is connected from the two current source connectors (marked SOURCE) to the unknown resistance. A second pair of test leads is connected from the voltmeter input terminals (+ and - jacks) to the unknown. Current from the current source now does not flow through the voltmeter leads, so the resistance of the test leads is not included in the measurement.

21.1.3. Offset and Scaling

Both voltage and resistance measurements may have any desired offset and scaling factor applied before the result is displayed. This mode is obtained

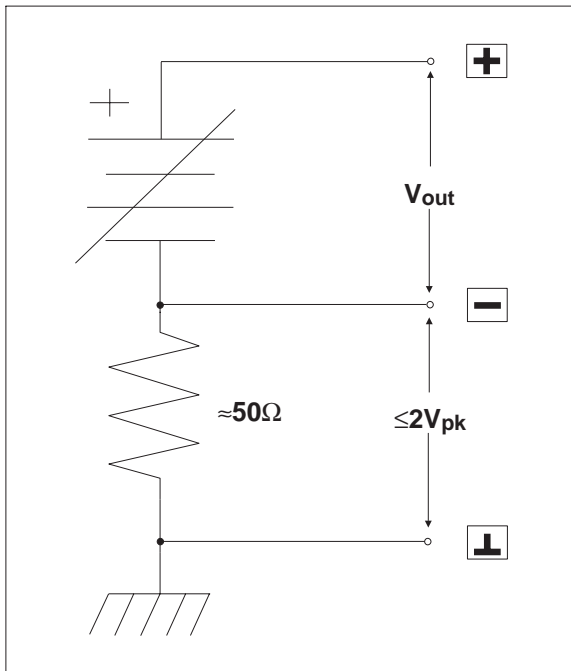

Figure 21-3 Equivalent Output Circuit, DC Outputs

for voltage measurements by selecting $f(V)$ rather than V_{dc} , and for resistance measurements by selecting $f(\Omega)$ rather than $OHMS$. This feature permits display in other units such as temperature, rather than directly in the electrical unit, when the output of a transducer is being measured.

When $f(V)$ or $f(\Omega)$ is selected, the value entered on the $OFFSET$ line immediately below the DMM line on the DCX panel is first added to the actual measurement. The resulting number is then multiplied by the $SCALE$ value on the next line, with the final resulting computation displayed on the DMM line. Thus, in $f(V)$ or $f(\Omega)$ modes:

$$\text{display} = (\text{measurement} + \text{OFFSET}) * \text{SCALE}$$

21.2. DC Voltage Outputs

Two independent dc voltage outputs are available at the $DCX-127$ front panel. Each may be set with 20 microvolt resolution to any voltage in the (10.5000 Volt range).

The dc output values may be directly controlled from the DCX panel by entering the desired number in the $DC\ OUT\ 1$ or $DC\ OUT\ 2$ fields. Either $DC\ OUT\ 1$ or $DC\ OUT\ 2$ may also be selected as $SOURCE-1$ or $SOURCE-2$ on the $SWEEP\ (F9)\ DEFINITIONS$ panel. Thus, either dc output may be swept in a test and will form the independent variable calibration on the x axis, either output may be varied via mouse or arrow keys in bargraph mode, and either dc output may be used in nested sweep fashion with other sweepable parameters such as generator frequency or amplitude.

Example applications of the dc outputs include sweep control of the gain, offset, or both ports of voltage-controlled amplifiers (VCAs) while measuring their gain, distortion, or noise and plotting those values versus control voltage. The dc output could also be used to control the position of a dc-controlled turntable while measuring polar response patterns of a loudspeaker or microphone. Manually operated test equipment with a dc control port (such as the VCF input of a function generator) may be controlled by the dc outputs. Tape machines with dc-controllable bias oscillators may be connected, enabling MOL , SOL , sensitivity, and other data to be taken automatically.

The dc outputs may be floated up to 2 Volts away from ground. See Figure 21-3 for the equivalent output circuit of both dc outputs. The maximum current which may be drawn from them is 20 milliamperes. When OFF is selected rather than V_{dc} on the $DCX-127$ control panel, the dc output becomes an open circuit.

21.3. Digital Input

A parallel digital word of up to 21 bits plus sign bit, at LSTTL-compatible levels, may be connected to the digital input connector of the $DCX-127$. The value of this word is displayed on the DCX panel at the $DIGITAL\ IN$ line. The data may be displayed in DEC imal or HEX adecimal representations, or the decimal value may be multiplied by the $SCALE$ value on the next line and displayed in $g(x)$ mode. In addition to display on the DCX panel, $DCX\ DIGIN$ may be selected at $DATA-1$ or $DATA-2$ on

CONN. PIN	FUNCTION 2sC MODE	FUNCTION BCD Mode
1	ground	ground
2	bit 0 (lsb)	LS digit 1
3	bit 1	LS digit 2
4	bit 2	LS digit 4
5	bit 3	LS digit 8
6	bit 4	5th digit 1
7	bit 5	5th digit 2
8	bit 6	5th digit 4
9	bit 7	5th digit 8
10	bit 8	4th digit 1
11	bit 9	4th digit 2
12	bit 10	4th digit 4
13	ground	ground
14	bit 11	4th digit 8
15	bit 12	3rd digit 1
16	bit 13	3rd digit 2
17	bit 14	3rd digit 4
18	bit 15	3rd digit 8
19	bit 16	2nd digit 1
20	bit 17	2nd digit 2
21	bit 18	2nd digit 4
22	bit 19	2nd digit 8
23	bit 20 (msb)	MS digit 1
24	sign	sign
25	strobe	strobe

Figure 21-4 Pin Assignments, Digital I/O

the SWEEP (F9) DEFINITIONS panel to produce graphs, tabular displays, and bargraphs. Limit files may be created for the DIGIN parameter and connected to a test for automatic comparisons of measurements to limits. See the ACCEPTANCE TEST LIMITS chapter beginning on page 24-1 for more details.

This digital word reading capability is compatible with data in either two's complement format (binary plus a sign bit) or in 8-4-2-1 binary coded decimal (BCD) format, selected by the 2sC (two's complement) or BCD choices on the same line as the SCALE value. The relationship between digital input connector pin number and data in either of these formats is shown in Figure 21-4.

The RATE line permits selection of four software sampling rates of the data presented to the connector, or selection of EXTERNAL. EXTERNAL mode will be used for data presented along with a "data good" pulse or "conversion completed" pulse. In this mode, the data at the input connector will be sampled and displayed on each positive-going edge at the strobe line (pin 25) of the connector. The maximum sampling rate is approximately 30 readings per second with an 8088-based computer and 150 readings per second with an 80286-based computer..

One application of the digital input capability is static (dc) linearity testing of analog-to-digital converters. Stimulus to the converter would be from one of the dc outputs. A typical test would use the DCX DCOUT1 or DCOUT2 as SOURCE-1 (graph horizontal axis) and DCX DIGIN as DATA-1 (graph vertical axis). Another application of digital input is to connect a parallel output digital measurement device such as a capacitance meter or high-resolution dc meter to System One. The digital input would also permit connection of a SMPTE time code reader to allow tracking of tape position during timing.

21.4. Digital Output

An LSTTL-compatible parallel digital output word of up to 21 bits plus sign may be created at the digital output connector. The value of this word may be entered in DECimal or HEXadecimal representations, or h(x) may be selected and the entered value will be divided by the SCALE value on the following line before it controls the output word and the DIGITAL OUT display.

With HEXadecimal representation selected and the values a through f (decimal 10 through 15) desired, a leading 0 (zero) must be entered since the system will not accept a leading alphabetic character in a numeric entry field.

When DECimal or HEXadecimal representation is selected, it is also possible to enter data from the keyboard in octal representation by using the alphabetic character "o" (not zero) after the digits. For

example, entering 10o will result in a display of 8 DECimal (8 HEXadecimal), entering 12o will result in 10 DECimal (a HEXadecimal), and entering 22o will result in a display of 18 DECimal (12 HEXadecimal). In DECimal representation, hexadecimal data may be entered by using the character "x" after the digits. Thus, 10x will produce a 16 DECimal action.

The format of the word presented at the connector (bit-to-pin relationship) may be selected as 2sC (two's complement) or BCD (8-4-2-1 binary coded decimal) on the same line with DIGITAL OUT SCALE. The pin connections are identical to the digital input connector, shown in 21-4. The strobe line (pin 25) will be pulsed low each time a new value is entered from the DCX panel or in a sweep.

In addition to direct entry on the DCX panel, the DIGITAL OUT word may be selected as DCX DIGOUT at the SOURCE-1 or SOURCE-2 fields on the SWEEP (F9) DEFINITIONS panel. The output word may then be swept as the independent variable (horizontal axis of a graph or first column of a table), may be operated in nested sweep fashion with another sweepable parameter, or may be controlled in quasi-analog fashion from the arrow keys or mouse in bargraph mode.

A typical application of digital output is in static (dc) linearity testing of digital-to-analog converters. The digital output word drives the converter; the analog output of the converter is measured with the DCX-127 DMM. With DCX DIGOUT selected as SOURCE-1 and DCX DMM selected as DATA-1, a graph of linearity will result. For high-resolution converters at output voltages more than 200 mV away from zero, it will be desirable to use one of the DCX-127 dc outputs in conjunction with the DMM input in differential voltmeter fashion so that the DMM can be on its highest resolution range.

Another application of the digital output is control of digitally-controllable turntables during polar response testing of microphones and loudspeakers. Still another application is in testing multiplying digital-to-analog converters (MDACs) used as variable resistors, attenuators, or in other audio applications.

```

-----|-----1-----|||-----2-----|-----3-----|-----4-----|
1=LOAD PROCEDURE M101FULL/R RUN PROCEDURE
2=LOAD PROCEDURE M101SHRT/R RUN PROCEDURE
3=LOAD PROCEDURE S2244/R RUN PROCEDURE

```

Figure 21-5 Example Macro Editor for Three Procedures

Each bit output has a five milliamperere current drive capability and 390 Ohms output impedance.

21.5. Program Control Input

The program control input capability is designed principally for production test applications where it may be best for test station operators to not have access to a full PC keyboard. Up to eight pushbuttons, foot switches, or other types of momentary contacts to ground can be wired to this connector. Closure of a contact will cause a stored keystroke sequence to be "re-played". The keystroke sequence associated with each connector pin is created in the Edit Macro mode, and a set of definitions of the sequences for one or more pins is saved to disk or loaded from disk with the Save Macro and Load Macro commands. Thus, a given set of switches may have their functions re-defined as desired for different applications.

Macros may be typed directly into the Macro editor, may be "learned" into the Procedure editor in Util Learn mode and then copied into the Macro editor with the <Alt><F6> and <F5> keys, or a combination of the two methods. The Util Learn and

```

-----|-----1-----|||-----2-----|-----3-----|-----4-----|
1=↑
2=→
3=↓
4=←
5=+
6=/R
7=/E
8+=F1

```

Figure 21-6 Example Macro Editor for Normal Menu Control from Limited Keyboard

copy technique is required if any of the desired keystrokes cannot be directly generated during Edit mode. Examples include the arrow keys, <Ctrl><Home> key, etc. See the Edit Macro section of the MENUS chapter for full information on the required formats for macros.

One possible use of the Program Control Input and macro capability is to directly load and run specific procedures at a single keystroke. This might be typical at a production test station where a relatively small number (eight or fewer) of procedures need to be selected among at a given time. In this mode, it may not even be necessary for a monitor to be connected to the computer. Different sets of procedures could be exchanged by loading different macros and perhaps changing an overlay card which labels the key switches connected to the Program Control Input connector. Figure 21-5 is an example of a macro file for such an approach.

Another possible use of the Program Control Input is to permit the operator to use the normal menu selection capability of System One software without any possible intimidation or confusion factors due to a full computer keyboard. This can be accomplished by defining the user-added switches as the four arrow keys, the <+> key to move among the selections on the menu line, the <Enter> and <Esc> keys, and the <F1> key to abort procedures and turn off the generator. The operator may then select among any previously-prepared tests and procedures in the current directory and may run the tests, but cannot change directories or make alphabetic or numeric input. See Figure 21-6 for an example of such a macro file.

21.6. Program Control Outputs

The Program Control Output connector provides six pulse or gate signals controlled by various actions of System One software. The pin assignments are shown in Figure 21-7. All lines are LSTTL compatible.

The Reset output, pin 2, pulses high when the DCX-127 power is turned on and whenever a Util Restore menu command is executed. The Reset out-

CONNECTOR PIN	FUNCTION
1	Delayed Sweep Gate
2	Reset
3	Data Acquired
4	Trigger
5	Undefined
6	Sweep Gate
7	Channel A/B
8	Ground
9	Ground

Figure 21-7 Program Control Output Connector

put would typically be used to normalize the condition of external logic devices connected to a System One test station at power up. It may also be invoked in a procedure by inserting a Util Restore command into the procedure.

The Data Acquired output, pin 3, pulses high each time that a set of data satisfies the settling algorithm. See the Sweep Settling section of the SWEEP (F9) DEFINITIONS PANEL chapter for full details on the settling algorithm. This signal could be used, for example, to cause a Compact Disc player to automatically advance to the next track whenever a successful set of measurements is completed on the preceding track. This is useful during an EXTERNAL FREQUENCY or EXTERNAL AMPLITUDE test across a series of tracks of a test disc.

The Trigger output, pin 4, pulses high at the end of each DELAY portion of the settling process. SETTLING DELAY, in a generator-based sweep, is the time after the generator steps to a new value before the software starts examining data samples to see if they are settled. This signal could be viewed on a dual-trace oscilloscope along with the signal being measured, to verify that the DELAY has been optimally set to discard "left over" data from the previous generator step when measuring systems such as 3-head tape recorders or satellite paths which have significant time delays. The Trigger output of the DCX-127 could also be connected to the TRIGGER/GATE input of the generator when the BUR-

GEN module is present. This will synchronize tone bursts in the SINE TRIG mode with the system's readiness to make a measurement. The Trigger output could also be used to strobe an external device being tested, such as an analog-to-digital converter. This will help insure that the source is stable before the conversion takes place.

The Sweep Gate output, pin 6, drips low at the beginning of a sweep test and goes high at the completion of a test. In a nested sweep, it will go high momentarily at the end of each SOURCE-1 sweep and drop low again for the next SOURCE-1 sweep after the SOURCE-2 parameter is incremented. One example application of the Sweep Gate output is in testing of the attack characteristics of compressors, limiters, and similar audio processors. With the Sweep Gate connected to the TRIGGER/GATE input of the generator when the BUR-GEN module is present and the SINE GATE mode is selected, time zero on a time sweep graph and the start of the signal will be synchronized.

The Channel A/B output, pin 7, goes low whenever analog analyzer input channel A is selected and high whenever input channel B is selected. The level at this pin thus indicates which channel is being measured during a STEREO sweep.

The Delay Gate output, pin 1, is similar to the Sweep Gate signal but with the addition of a user-settable delay time between the actual beginning of a sweep test and the leading edge of the gate output signal. This delay time is entered at the bottom of the DCX software panel, in the GATE DELAY field.

An example application is power amplifier turn-on and turn-off transient ("thump") testing. The amplifier power could be turned on by the sweep gate and off by the delayed gate. The output of the amplifier may be measured during a time sweep. To allow correct capture of transients, the LEVEL meter should be used along with a fixed input range.

Another example application is to start a tape machine or turntable for run-up time testing. The basic measurement technique is to perform a time sweep while measuring frequency from a pre-recorded tape

CONNECTOR PIN	FUNCTION
1	bit 7 (msb)
2	bit 6
3	bit 5
4	bit 4
5	bit 3
6	bit 2
7	bit 1
8	bit 0 (lsb)
9	ground

Figure 21-8 Digital Control Outputs A, B, C

or disc. Use of the Delayed Sweep Gate to start the recorder or turntable permits System One to draw the graph when <F9> is pressed, start the time sweep, and then start the machine at a predetermined time into the sweep when the software is ready to take continuous, rapid measurements.

21.7. Digital Control Output Ports

Three rear-panel 9-pin connectors are provided on the DCX-127 for control of external devices. These output ports are intended for direct interface to LSTTL circuitry, or via LSTTL-compatible drivers to relays. Control of power, lights, annunciators, etc., are among the possible applications. The pin connections of these ports are shown in Figure 21-8. The current drive capability of each bit line is five milliamperes; the output impedance is 390 Ohms.

An 8-bit parallel word at each of these connectors may be controlled in either of two fashions. One control method is via entry of a number into the PORT OUT fields near the bottom of the DCX panel. The second method is via the UTIL OUT menu command.

The PORT OUT A, B, and C fields refer to the connectors labeled A, B, and C on the DCX-127 rear panel. Numbers may be entered into these fields in either DECimal, HEXadecimal, or OCTal representations. Any numbers in these fields when a .TST or .OVL file is saved will be reloaded and thus will control the port conditions when that test

or overlay file is next loaded. DCX panel control of the ports will thus normally be used when a specific external condition is to be set up for a specific test. When only a small number of lines are to be controlled, individual pins can be treated as independent lines. OCTal representation of the data may be simplest in this case, since each octal digit can be mentally decoded to a three-bit binary word with each bit representing a control line. For complex control situations, external decoding can be used to obtain up to 256 logic states from each 8-bit port. In such a case, the DECimal or HEXadecimal representations may be preferred.

The alternate method of controlling ports A, B, and C is with the UTIL OUT menu command. The UTIL OUT command, in general, permits writing any data word to any address of an IBM-compatible personal computer. The DCX-127 A, B, and C ports are three special cases of address. Only decimal representation is acceptable in the UTIL OUT command. Thus, to set the least significant and most significant bits high at port B, the menu command would be:

```
UTIL OUT B,129 <Enter>
```

The Util Out method is useful for controlling Pass/Fail lamps in a procedure since the command may be placed inside an IF ERROR[or IF NOTER-ROR[command.

22. REMOTE MODE FOR TRANSMISSION TESTING AND LAPTOP COMPUTER OPERATION

22.1. Introduction

In normal operation of System One, control commands and measurement data flow back and forth between S1.EXE software and the System One hardware via a PCI interface card plugged into a computer expansion slot. The REMOTE mode of S1.EXE software instead functions by re-directing portions of the control and data flow between computer and instruments to an alternate serial communications (RS-232) path. REMOTE mode was developed for two types of applications:

- measuring audio transmission links where the audio input and output are at different physical locations (“split site”), as in typical broadcasting, satellite, and microwave operation
- to permit the use of a System One “S” (serial interface) version with a laptop or notebook computer which does not have expansion slots for a PCI interface card.

REMOTE operation involves the REMOTE-LOCAL choice in the top borders of several panels, the Run Remote, Run Local, and Run Slave menu commands, the DOS MODE command, and several command line options used when starting S1.EXE software. When LOCAL is selected at the top of the GENERATOR, ANALYZER, DCX-127, SWITCHER, or DSP panels, S1.EXE software expects to find that particular device connected to a PCI interface card plugged into the computer. When S1.EXE has been started with the proper command line options, the Run Remote menu command has been executed, and REMOTE is selected on any (or all) of those panels, S1.EXE attempts to communicate with the selected device(s) via the computer’s serial port. A computer (typically laptop or notebook) may thus control a nearby serial interface version System One by a direct RS-232 cable. For distant location of the RS-232-controlled System One, modems and a data communications link may inter-

connect the controlling computer’s serial port with either a distant serial interface System One, or with the serial port of a distant computer which is also connected via PCI card to a System One located nearby.

A distant System One and SWR-122 switchers, even at an unstaffed repeater or remote transmitter location, can be operated via modems and a data communications link from another computer at any point. With SWR-122P insertion type switchers, signal can be monitored at many points at the repeater or transmitter without interrupting normal program flow. Additionally, an engineer at the control point can break normal signal paths to inject test signals from the System One at that location or measure unloaded output of a device.

22.2. System Architecture, Testing at Two Locations with Two Computers and “A” Version Systems

The system diagram for two computers, “A” version System Ones, and data communications equipment is shown in Figure 22-1. The digital interface cabling between the PCI card installed in the computer and the System One at the same physical location is identical to normal, local operation. If SWR-122 switchers are used at either end, their control cables are also connected to the Audio Precision Interface Bus.

Both computers must have serial (RS-232) communications ports. For remote operation at moderate distances within a facility (up to approximately 300 meters), a direct RS-232 cable connection can be made between the computers with no modems required. Larger separations will involve a data communications line and modems. The serial port of each computer then connects to a modem. The two

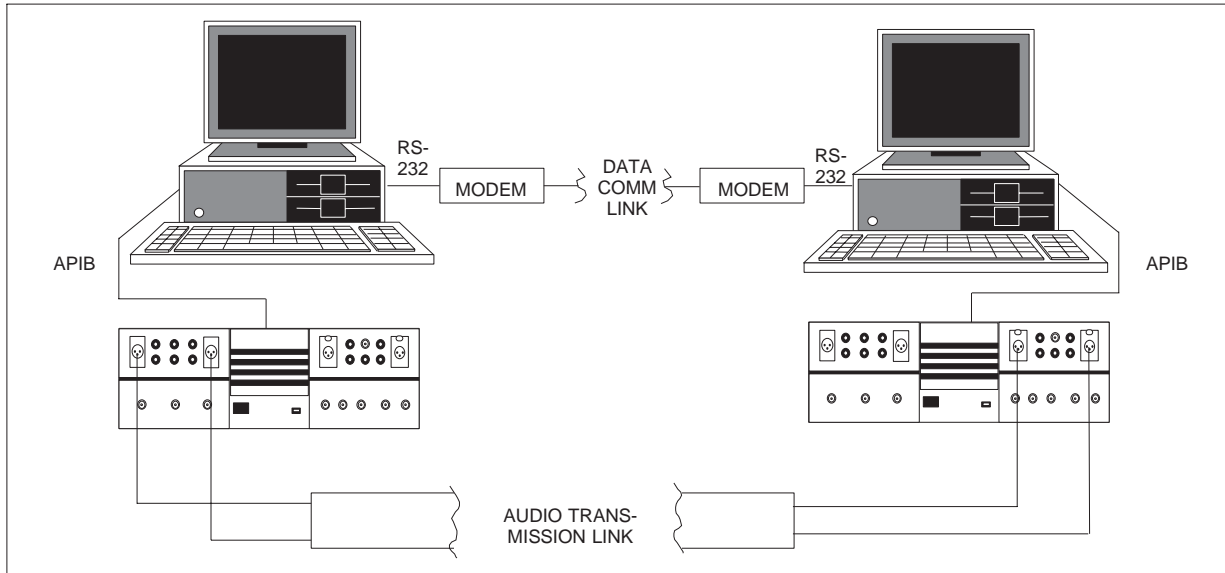

Figure 22-1 Block Diagram, Remote Testing of Transmission Link with Two Computers, Two Modems, and Two "A" Version Systems

modems connect to a data communications link, such as a dial-up telephone line or dedicated data comm link, between the locations.

The slave computer software must be in Run Slave mode. The computer at the master end of the RS-232 link can then select the Run Remote menu command and select REMOTE operation in the top border of the GENERATOR, ANALYZER, DSP, or SWITCHER panels, or any combination of them. The operator at the master unit has control over the selected generator, analyzer, DSP, or switcher hardware at either end of the system. Settings such as impedances, frequencies, filters, detectors, etc., at the selected generator or analyzer are controlled from the master computer in identical fashion whether local or at a great distance. Measurements made by the selected analyzer or DSP unit, even if thousands of miles away, will appear on the master control computer screen in PANEL, bargraph, or graphic modes. Data can be stored at the master location. If the link is bidirectional, master and slave roles can be interchanged to test the audio transmission link in either direction by pressing any key at the slave unit to put it into normal mode and then selecting Run Remote. At the former master unit, press <Esc> Run Slave to place it into slave mode.

22.3. System Architecture, Testing at Two Locations with "S" Version System

If one location will never be the control point, an "S" version System One can be used with no computer required at that location, as shown in Figure 22-2. The modem then connects directly to the RS-232 connector on the rear of the "S" version system. Any SWR-122 switchers at that remote location connect to the APIB connector on the rear of the "S" version unit. The "S" version then converts switcher control commands from RS-232 protocol to normal APIB functions in order to control the switchers. Any SWR-122 switchers used at the master control point are connected to the APIB running between computer and "A" version system.

The computer at the master end of the RS-232 link can then select the Run Remote menu command and exercise control over part or all of the "S" version system, which is effectively always in "Run Slave" mode when operating from RS-232. The master unit can select REMOTE operation in the top border of the GENERATOR, ANALYZER, DSP, or SWITCHER panels, or any combination of them. The operator at the master unit then has control over the selected generator, analyzer, DSP, or switcher hardware at either end of the system. Settings such

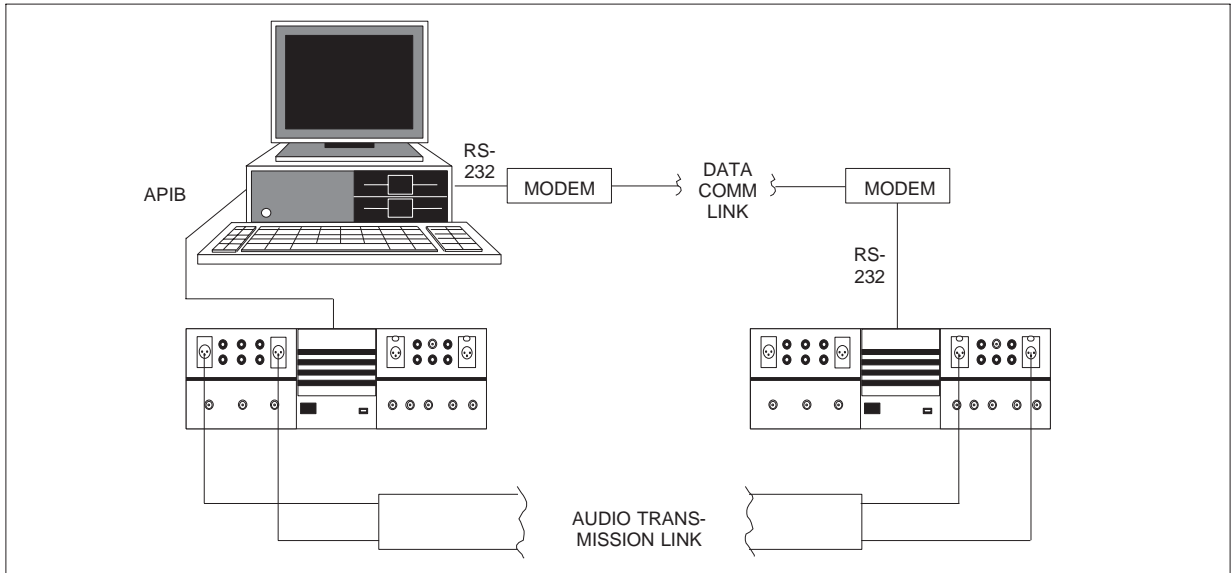

Figure 22-2 Block Diagram, Remote Testing of Transmission Link with “S” Version System One at Remote Location

as impedances, frequencies, filters, detectors, etc., at the selected generator or analyzer are controlled from the master computer in identical fashion whether local or at a great distance. Measurements made by the selected analyzer or DSP unit, even if thousands of miles away, will appear on the master control computer screen in PANEL, bargraph, or graphic modes.

22.4. System Architecture, Laptop/Notebook Computers

Laptop and notebook computers without expansion slots for a PCI interface card can control a System One “S” version via RS-232. Figure 22-3 shows the interconnection between a computer with no expansion slot and an “S” version System One. The RS-232 port on the computer connects directly to the RS-232 port on the serial version System One, using a “null modem” cable. Null modem cables or adapters can be purchased at most computer stores. No modems are required in this architecture. Switches on the rear of the “S” version select baud rate and other communications-related parameters.

22.5. Master and Slave; General Concepts

With computers at both ends, the System One at the distant (remotely controlled) location is placed into slave mode by the Run Slave command of S1.EXE software. An “S” version System One is always effectively in slave mode when the rear panel APIB/RS-232 switch is set to RS-232. The master

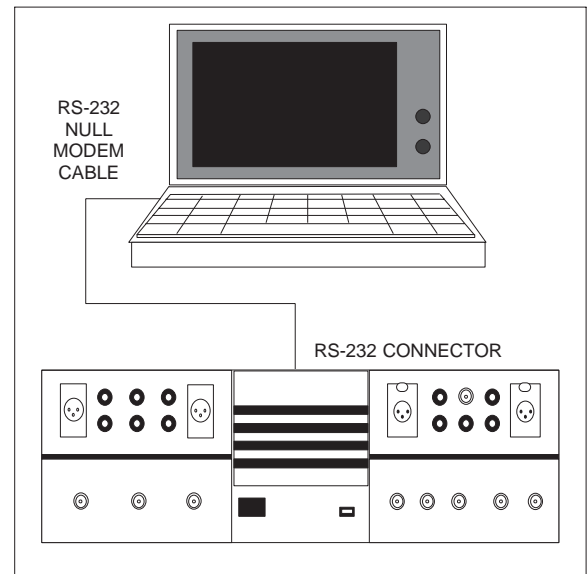

Figure 22-3 Block Diagram, Laptop Computer with “S” Version System One

mode at the controlling unit is selected by the Run Remote command. A sophisticated packeted data transmission scheme is used between the two ends of the link, featuring error detection and correction by re-transmission of faulty packets. Both master and slave send data to the other unit in packets, using a 16-bit CRCC (cyclic redundancy check code) for error detection.

When the master sends new settings instructions to the slave, the slave unit checks each packet for errors and either acknowledges correct reception or requests that the packet be re-sent. If the master unit does not receive acknowledgement within the communications time-out interval, it assumes the packet was lost and re-sends it.

When the master requests measurements data from the slave (assuming the slave unit analyzer is enabled), the slave sends the data as a packet. The master checks the packet for errors and requests a re-transmission if errors are found. If the requested data is not received within the communications time-out interval, the master makes another request.

At 300 baud rates, the communications time-out must be set to four seconds because of additional delays involved in 300 baud transmission. The /T command line option is used at System One software loading to set the communications time-out to any value other than one second. See the command line options section on page 22-12 for more details.

22.6. Control Computer Operation

In all three of these architectures, operation of the controlling computer is similar or identical. These are the key operational points for the controlling computer:

a. S1.EXE software must be started with either the /C1 (to select the COM1 port) or /C2 (COM2 port) option. The /An and /Tn options may also be desirable; see the "Command Line Options" section on page 22-12 for information on them.

b. REMOTE must be selected in the top border of one or more of the GENERATOR, ANALYZER, SWITCHER, DCX-127, and DSP panels. The ANALYZER, DSP, and DCX-127 are mutually dependent and must all be either REMOTE or LOCAL; when any one of these is switched between REMOTE and LOCAL or vice-versa, all are switched together. For laptop computer operation of an "S" version system, REMOTE will be selected in all these panels. For "split site" testing of audio transmission links, REMOTE will be selected in the panels of the instrument modules which will be used at the distant location and LOCAL will be selected for the instrument modules which will be in use at the control location.

c. The Run Remote menu command must be executed.

22.7. Remote System Operation

The controlled unit hardware and software functions differently for each of the three architectures.

1. For operation from a laptop or notebook computer with no PCI card, an "S" version System One is required. This unit operates in its RS-232 interface mode, typically at a fast baud rate such as 9600 or 19200. No modems are required. See the "Laptop Computers with S-Version Systems" section below for full details.

2. For audio transmission link testing with no computer at the distant point, an "S" version System One and a Hayes Smartmodem-compatible modem are required. The S-version system operates in its RS-232 interface mode at the baud rate which the modem and data communications link can support. Often, the S-version system operates in Auto Answer mode so that it and the modem can answer whenever the modem is called from a controlling computer and modem. See the "Transmission Testing with S-Version System" section on page 22-6 for full details.

3. For audio transmission link testing with computers at both ends, modems are also required at both ends. The modems in this case need not be

identical and need not be Hayes-compatible, as long as both are compatible with the data communications link and operate at a common baud rate.

S1.EXE software at the remote end must be started with the /C1 or /C2 option, depending upon which computer COM port is being used. The /H option may be relevant; see below for more information. The Run Slave menu command must be executed, or S1.EXE must be started with the /S option which puts it automatically into Run Slave mode. See the "Transmission Testing with Two Computers" section on page 22-8 for more information.

22.7.1. Laptop Computers with "S" Version Systems

The serial port on "S" version System Ones is an RS-232C interface of the DTE (Data Terminal Equipment) type using a DB25P (male) connector. IBM-compatible computers are also configured as DTEs. Therefore, when System One is to be connected directly to a computer, the use of a "null modem" adapter is required. Many computer stores carry ready-made null modem cables, null modem adaptors, and 9-to-25 pin adaptors. The following information is furnished to permit you to make your own null modem cable.

For an AT type computer with a DB9P connector to System One, wire a null modem cable as follows:

DB9S (Female)		DB25S (Female)	
To IBM-AT		To System One	
NAME	PIN #	PIN #	NAME
RX	2	2	TX
TX	3	3	RX
SG	5	7	SG

With the 9-pin connector, a safety ground between units is normally made by connecting to the connector shells.

For an XT type computer with a DB25P connector to System One, wire a null modem cable as follows:

DB25S (Female)		DB25S (Female)	
To IBM-PC		To System One	
NAME	PIN #	PIN #	NAME
PG	1	1	PG
RX	3	2	TX
TX	2	3	RX
SG	7	7	SG

To control and communicate with an "S" version System One, the laptop computer must have its DOS MODE command properly set. Since no modems are involved, 9600 baud (or possibly 19200 baud if supported by the computer) will always be used. MODE.COM is an "external" DOS command; that is, it is actually an independent program. It must therefore either be in a directory named in the DOS PATH command, or must be in the current directory in order to run. The typical mode commands for laptop computer operation are

MODE COM1:9600,N,8,1 <Enter> for comm port 1, or

MODE COM2:9600,N,8,1 <Enter> for comm port 2

See the DOS MODE section on page 22-11 for more details.

The rear switches on the "S" version unit must be set for RS-232 interface, auto-answer off, and to match the computer baud rate. With the typical 9600 baud rate, the switches will be set to 000110. See the "Switch Settings" section on page 22-10 for more information and a drawing of the switches.

The computer must load S1.EXE software with the appropriate command line options. All .TST files must have REMOTE set into the top field on each panel. The Run Remote command must be run after S1.EXE software is started. To simplify these operations, a special diskette has been prepared for laptop computer operation. This diskette includes two batch files (one for COM1 and one for COM2) which load the software with the proper command line options. Duplicates of all the normal test files are also furnished on this diskette with the top fields

stored as REMOTE instead of LOCAL. If you did not receive this diskette when you purchased an "S" version system to use with a laptop computer, contact Audio Precision or your Audio Precision International Distributor for a free copy.

The following instructions assume that you have copied the contents of the laptop diskette onto your computer's hard disk according to the instructions furnished with the diskette, or made a "work copy" on another diskette. You will use the batch file name instead of "S1" to start the software. If the "S" version system is connected to COM1, use

S1C1 <Enter>

If the unit is connected to COM2, use

S1C2 <Enter>

The batch file listing for S1C1.BAT is as follows (S1C2.BAT differs only in the comm port specified):

```
S1 /C1 /I0 S-SETUP
```

The /C1 option specifies comm port 1. The /I0 option stipulates that no PCI card is present, so that S1.EXE will not display the "no PCI card" warning message each time it loads. S-SETUP is the name of a procedure which executes the RUN REMOTE command and loads a test named REMOTE.TST which has all panels set to REMOTE rather than LOCAL.

Should settings be lost at a remote System One due to lost power or cables becoming disconnected, UTIL RESTORE may be used to restore a remote System One in the same manner as a local System One.

22.7.2. Transmission Testing with "S" Version System

To put the modems into communications with one another, data communications software will be required at the master computer. Communications software is required that can dial the remote phone number, establish connection, then quit "quietly"

without causing the modems to disconnect. (*Crosstalk XVI is one communications program that has been tested to do this correctly by using its XDOS command to quit without disconnecting the modem. Another program, Crosstalk Mark 4, does not have this capability.*)

At the remote location, the modem connects directly to the "S" version System One and no data communications software is involved. System One is configured as a DTE port to allow it to be connected directly to a modem. For connecting System One to a modem, wire a "straight-through" cable as follows:

DB25P (Male) To Modem		DB25S (Female) To System One	
NAME	PIN #	PIN #	NAME
PG	1	1	PG
TX	2	2	TX
RX	3	3	RX
RTS	4	4	RTS
CTS	5	5	CTS
SG	7	7	SG
DCD	8	8	DCD
DTR	20	20	DTR

22.7.2.1. Modem Usage with "S" Version System One

When set to the "auto answer" mode (see the "Switch Settings" section on page 22-10 of this chapter), System One can communicate with a Hayes Smartmodem-compatible modem to automatically answer telephone lines allowing completely unattended operation. The modem must be configured to use both the DTR and DCD RS-232C control lines and to recognize "Smartmodem" commands.

For the Hayes Smartmodem 1200, the configuration switches must be set as follows:

Sw	#	Pos.	Function
	1	UP	Support RS-232C DTR control line
	6	UP	Support RS-232C DCD control line
	8	DOWN	Enable command recognition

“S” version System One does not care about the position of the other modem switches.

For the Hayes Smartmodem 2400, all settings are done using commands from the “S” version unit as there are no switches. Make sure that the “dumb mode strap” is in the “smart” position to enable command recognition. No further setup needs to be done for the 2400. Also, System One will not change anything in the modem that is not required for its operation. This allows selection of speaker usage, telco jack and line type, pulse dial ratios, etc. to remain intact.

Note that there are some obscure S registers settings in both the Hayes 1200 and 2400 that could cause problems with System One operation. (There are some settings that can prevent the modem from functioning at all.) The assumption is made that the S registers are at factory default.

Once the modem is connected to the System One serial port and both System One and the modem have power turned on, the modem will be automatically configured to answer the phone. To prevent the modem from unexpectedly answering by itself, System One does the actual answer using Smartmodem commands. The Auto Answer light (normally labeled “AA” on the modem) will thus not come on. This is normal. The order in which power is applied to System One and the modem is not critical.

The following sequence of actions must take place for a master computer to successfully control modules of both the local “A” version and remote “S” version System Ones, assuming a dial-up telephone line is being used as the data comm link.

- a. the DOS MODE command must be run to select the proper parameters for the computer-RS-232 port linkage. Some data communications software automatically sets the parameters
- b. the “originate” (master) unit modem must go off-hook (equivalent to picking up the telephone)

- c. the originate unit modem must dial the telephone number of the distant (“answer”, or slave) unit
- d. the answer (slave) unit modem must answer by going off-hook and putting its carrier on the line
- e. the originate unit modem responds by putting carrier on the line
- f. both modems detect carrier. The master modem notifies the master computer and the slave modem notifies the computer imbedded in the “S” version unit
- g. the data communication software at the master computer quits to DOS without disturbing the COM port. Note that many types of data communication software do not have this capability and effectively break communications when they exit or quit; such data comm software cannot be used with System One REMOTE mode
- h. the remote “S” version unit must have had its rear-panel switches set for RS-232 control. The auto answer switch, if on, selects auto answer mode. The “S” version unit automatically starts in the equivalent of Run Slave mode when power is turned on
- i. at the master unit, the command S1 /Cn (with any other appropriate command line options) is run to load S1 software with the appropriate comm port selected, followed by Run Remote to enable the REMOTE/LOCAL selections on any panels

At the completion of remote testing operation, this sequence must take place:

- j. master unit quits from S1 software to data comm software. Quitting S1.EXE at the master control location will cause the DTR control line on the RS-232C port to go low, causing the master modem to hang up (it should be configured to recognize DTR)
- k. slave unit modem detects loss of carrier, notifies the “S” version System One of carrier loss, and System One hangs up phone.

The "S" version unit goes back into auto answer mode if the selection switch has been set to that position and waits for modem communications to be re-established.

System One's REMOTE operation has been tested with the Crosstalk XVI (TM) data communications software. It should operate with other types of data comm software if that software quits (to DOS) without changing the parameters which the software set up while operating. Data communications software is often capable of automatically dialing a telephone number (autodial). With the "script file" capability of Crosstalk software and the batch file capability of DOS, it is practical for all the operations listed above to be executed automatically.

Should settings be lost at a remote System One (due to lost power or cables becoming disconnected), UTIL RESTORE may be used to restore a remote System One in the same manner as a local System One.

22.7.3. Transmission Testing with Two Computers

To put the modems into communications with one another, data communications software will be required. At the master end, communications software is required that can dial the phone number, establish connection, then quit "quietly" without causing the modems to disconnect. (*CrossTalk XVI is one communications program that has been tested to do this correctly by using its XDOS command to quit without disconnecting the modem. Another program, Crosstalk Mark 4, does not have this capability.*)

System One's REMOTE operation between two computers is independent of the particular type and brand of modem, as long as the modem is RS-232 compatible and compatible with the computer and data comm software being used. The modems at the two ends of the data comm link need not be identical.

The following sequence of actions must take place for a split-site set of System One units and computers to go into successful operation, assuming a dial-up telephone line is being used as the data comm link.

- a. the DOS MODE command must be run at both computers to select the proper parameters for the computer-RS-232 port linkage. Some data communications software automatically sets the parameters
- b. the "originate" (master) unit modem must go off-hook (equivalent to picking up the telephone)
- c. the originate unit modem must dial the telephone number of the distant ("answer", or slave) unit
- d. the answer (slave) unit modem must answer by going off-hook and putting its carrier on the line
- e. the originate unit modem responds by putting carrier on the line
- f. both modems detect carrier and notify their attached computer
- g. the data communication software at both ends quits to DOS without disturbing the COM port. Note that many types of data communication software do not have this capability and effectively break communications when they exit or quit; such data comm software cannot be used with System One REMOTE mode
- h. at the slave unit, the command S1 /Cn /S /H is run to load S1 software directly into the Run Slave mode with a specific communications port selected and auto quit at loss of carrier (hang-up) mode. See page 22-12 below for more information on command line options
- i. at the master unit, the command S1 /Cn (with any other appropriate command line options) is run to load S1 software with the appropriate comm port selected, followed by Run Remote to enable the REMOTE/LOCAL selections on any panels

At the completion of remote testing operation, this sequence must take place:

- j. master unit quits from S1 software and instructs master unit modem to hang up
- k. slave unit modem detects loss of carrier, notifies System One of carrier loss, hangs up phone
- l. for continuing readiness for further tests, S1.EXE software at the remote computer quits to the data comm software and a batch file puts modem into auto-answer mode.

System One's REMOTE operation has been tested with the Crosstalk XVI (TM) data communications software. It should operate with other types of data comm software if that software quits to DOS without changing the parameters which the software set up while operating. Data communications software is often capable of automatically dialing a telephone number (autodial) and of automatically answering when called (auto-answer). Some software-modem combinations are also capable of automatically setting the baud rate of multi-rate modems to the fastest rate which can be supported by the modems at both ends of the line (auto baud rate). With the "script file" capability of Crosstalk software and the batch file capability of DOS, it is practical for all the operations listed above to be executed automatically.

A batch file at the slave unit can be in a continuous loop. Then, whenever carrier is lost and System One quits, the data comm software is again loaded and waits for the number to be called again. The first action of the slave batch file is to load Crosstalk software with a crosstalk command file which sets the MODE parameters and goes into autoanswer mode. An attached Crosstalk script file tells Crosstalk to quit using Crosstalk's XDOS command after connection has been made. The next line of the batch file causes System One to select comm port 1 and load directly into the Run Slave and automatic quit at carrier loss modes via the /S and /H command line options. The complete batch file might thus be:

```
:BEGIN
XTALK ANSWER
S1 /C1 /S /H
GOTO BEGIN
```

This monitoring could be on a 24-hour-per-day basis. Alternately, the computer and System One could be turned on and off by timeclocks or a separate remote control link into the facility if available. Devices are also available which turn on power to the computer when a ring is detected by the modem.

Note that data communications software such as Crosstalk also allows users at the two computers to communicate with one another in real time, similar to teletype operation. Crosstalk also permits transmission of any files between the computers, such as the xx.TST files created by System One.

22.8. "S" Version System One, General Information

On the rear panel of "S" version System One are two DB25P (male) connectors. The top connector is for the APIB (Audio Precision Interface Bus). This is the same connector as found on "A" version System Ones. In the APIB mode, an "S" version system functions exactly like an "A" version system. The bottom connector is the serial port and is unique to "S" version System Ones. A miniature switch assembly on the rear panel selects between APIB and RS-232 interface and sets baud rate when in RS-232 mode. These switch settings are read by the microprocessor only at power-up, so power must be turned off and back on for any changed switch settings to become effective.

The "S" version of System One contains the equivalent of a high performance IBM-compatible computer with a serial port and a PCI card. This eliminates the need for a computer at the slave end of a "split site" installation, allowing direct serial communications between System One and a computer running the S1.EXE software. It also permits use of laptop and notebook computers, which normally do not have expansion slots which accept a PCI card, for more portable test systems.

The firmware in “S” version System Ones runs a program that emulates the “RUN SLAVE” portion of S1.EXE. It can also communicate with Hayes-compatible modems to automatically answer telephone lines allowing completely unattended operation.

The “S” version System One provides complete operation of the hardware when using the serial port, with the following exceptions:

1. The Program Control Inputs and Outputs on a DCX-127 module are not functional when connected to an “S” version System One being controlled by the serial port.
2. Panel indication of generator overload is not functional for a generator in an “S” version System One being controlled by the serial port.
3. LIB-C, LIB-BASIC, and the older LIB-MIX function libraries cannot be used to control an “S” version System One by the serial port.
4. The HELP screen will show the various System One modules as “not connected”, since it looks only at instruments connected to the PCI card.

The firmware in “S” version System Ones is specifically matched to certain versions of S1.EXE. Mis-matched firmware and software will be indicated by “remote setting timeout” error messages. A label is located on the rear panel of each “S” version System One indicating the firmware version and which versions of S1.EXE are compatible. All “S” version shipped before August, 1991, contained version 1.60C firmware. For information on upgrading these units to version 2.10 firmware in order that they can work with a computer running S1.EXE v2.10, contact Audio Precision or your Audio Precision Distributor.

22.8.1. “S” Version Switch Settings

A six-pole rear-mounted miniature DIP switch assembly (see Figure 22-4) selects between the RS-232 (lower) connector or the APIB (upper) connector on the rear. When in the RS-232 mode, addi-

tional switches select baud rate and the auto answer mode. All these switches are read by the internal microprocessor only when power is first turned on to System One. Thus, if any switch positions are changed, power must be turned off and then back on for the new settings to become effective.

The leftmost switch on this assembly sets which interface will be used by the hardware. When set to APIB (Audio Precision Interface Bus), System One will behave like an “A” version, using the APIB connected to a PCI card installed in an IBM-PC. The serial port will be ignored.

When this switch is set to RS-232, the serial port will be used. All commands received are repeated on the APIB port so that switchers, DCXs, etc. may be connected. Any devices connected to APIB will then be fully controllable from the serial port, with the exception of the DCX-127 Program Control inputs and outputs. The APIB port cannot be connected to a PCI card when RS-232C is in use.

The second leftmost switch sets the “auto answer” mode. When set to the “auto answer” position, System One will not operate unless a Hayes compatible modem connected to a dial-up phone line is attached to the serial port. Thus, this switch should not be in the “auto answer” position when used with a local laptop computer. When a Hayes compatible modem is attached, the modem will be

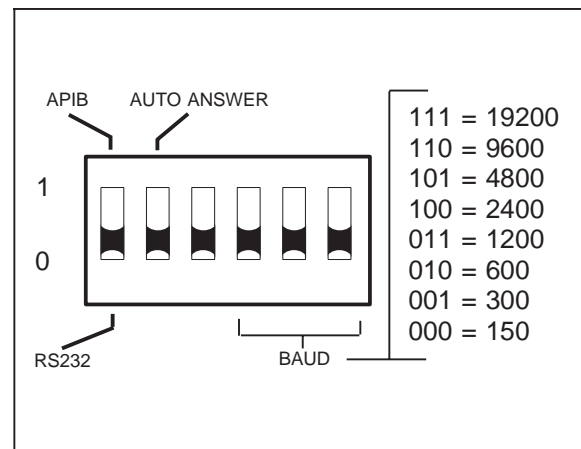

Figure 22-4 Rear-Panel Switch Assembly, “S” Version Systems

set to automatically answer any incoming phone calls. See the "Modem Usage" section of this chapter on page 22-6 for more details.

Note that when set to "auto answer", the RS-232C control lines RTS, CTS, DCD, and DTR are used. When not set to "auto answer", these lines are not used.

The third switch is not used.

The three remaining switches on the right control the baud rate of the serial port. When System One is connected directly to a computer, 9600 baud may be used. When a modem is used, 1200 or 2400 baud is typical.

Baud rates below 1200 baud are not recommended because of degradations in system performance. If slower baud rates must be used because of modem or comm line limitations, the /T option must be used for S1.EXE to change the default communication time-outs.

22.8.2. "S" Version Technical Details

The serial port on "S" version System Ones is an RS-232C interface of the DTE (Data Terminal Equipment) type using a DB25P (male) connector. A subset of the EIA RS-232C standard is used utilizing only RX, TX, DTR, CTS, DCD, and grounds PG and SG. Pin assignments are as follows:

PIN	#	NAME	DESCRIPT.	DIRECTION
	1	PG	Protective Ground	
	2	TX	Transmit Data	From System One
	3	RX	Receive Data	To System One
	4	RTS	Ready To Send	From System One
	5	CTS	Clear To Send	To System One
	7	SG	Signal Ground	
	8	DCD	Data Carrier Detect	To System One
	20	DTR	Data Term. Ready	From System One

Note that the control lines CTS, DCD, RTS, and DTR are only required for operation with a modem.

22.9. DOS Mode Command

The MODE command of DOS sets several critical computer parameters for data communications including baud rate, byte width, parity, and stop bits. The MODE command is an "external" DOS command; that is, a separate program stored on disk, rather than being built into the basic DOS program which is always in memory. Thus, the program MODE.COM must be in the current directory or a directory named in the PATH command before MODE can be set. The mode command can be run from DOS before loading S1.EXE (typically by an AUTOEXEC.BAT program), or can be run after loading S1.EXE during use of the XDOS menu function. The computers at both ends of the RS-232 communications link (or the "S" version System One at the remote location when only one computer is used) must be set to the same baud rate, 8-bit-wide bytes, no parity, and one stop bit before successful communications can be set up. The command to be run at each computer is:

MODE COMx: baud,N,8,1 <Enter>,

where COMx: is COM1: or COM2:, depending on which serial port is being used for remote operation. S1.EXE software must be started with the /Cn command line option if remote operation is to be used, where n is the number of the computer serial port to be used. For example, if the COM1 port is to be used, start the software

S1 /C1 <Enter>

If no /C option is specified, remote mode will not function.

The number entered instead of "baud" is a suitable baud rate for the computers, modems, and data communications link involved. Baud rates available from most computers include 110, 300, 1200, 2400, 4800, and 9600. Most modems available are 300, 1200, or 2400 baud, with still-faster modems available at premium prices. When a direct metallic RS-232 link is used rather than modems, the fastest baud rate available from the computer may be used (up through the maximum 19200 baud available if an "S" version system is connected at the "remote"

point). See the documentation for your specific computer to see if 19200 baud operation is available and how to select it. Early DOS versions only supported rates through 9600 baud. REMOTE operation at 300 baud will be quite slow compared to normal operation. For 300 baud or slower operation, the communications time-out value must be changed when S1.EXE is loaded; see the discussion under Master and Slave operation and the command line options section at the end of this chapter. At 1200 baud, operational speed for most real-time audio testing will be only moderately degraded compared to normal operation. At 2400 baud and faster, REMOTE operation speeds will be comparable to normal System One operation for real-time audio testing. With DSP units, transfer of DSP programs from master computer to system, upload or download of waveforms between master computer and system, and graphing of FFT spectra and waveforms involve transfer of large amounts of data and will be much slower, even at 9600 baud, than over the APIB with a PCI card.

N in the MODE command stands for no parity, required by System One software. The 8 represents the number of bits per character (byte) and must be 8 for System One REMOTE operation. The 1 designates one stop bit.

For 9600 baud communications via serial port 1, the command would be MODE COM1: 9600,N,8,1. For 300 baud modem communication via serial port 2, the command would be MODE COM2: 300,N,8,1.

When DOS accepts a MODE command, it will echo back a message such as:

COM1: 1200,N,8,1,-

If the DOS program MODE.COM is not in a current directory, the computer's response will be:

Bad command or file name.

If MODE is typed with the designation of a serial port not installed in the computer, such as COM2: when only one serial port is present, the response will be

Illegal device name.

Specifying an unavailable baud rate will result in the error message:

Invalid baud rate.

22.10. Command Line Options

The following command line options are available for use with REMOTE mode. In each case where "n" appears, it represents a number value for the command.

/An sets number of attempts the master will make at sending a particular packet or requesting a data packet from the slave, before displaying or updating an error message. Default value is four. This option is applicable only to the master unit.

/Cn selects COMn: as the serial port which System One will use for remote operation. This option must be run at both master and slave when two computers and "A" version systems are used.

/H automatic quit when carrier is lost. This option is applicable only to the slave computer. When an "S" version system is used at the remote location, a rear-panel switch turns the equivalent to the /H mode on and off. It would normally be off for use with a laptop computer, but on for automatic operation with modem at an unstaffed location.

/S load S1 directly into Run Slave mode. This option is applicable only to the slave. The "S" version (serial interface) System One is always effectively in Run Slave mode when turned on with its rear-panel switches set to the RS-232 (rather than APIB) mode.

/Tn sets the communications time-out value (in seconds). This is the length of time the master will wait for acknowledgement from the slave of correct settings packet receipt before re-sending the packet, or the length of time the master will wait after requesting a

data packet from the slave before making another request. The default value is 1 second. For 300 baud operation, /T4 should be used. At even slower baud rates, still longer timeouts should be used. This data communications time-out should not be confused with the TIMEOUT parameter on the SWEEP SETTling panel. This option is applicable only to the master.

Any number of these options may be combined on the command line, along with other command line options as described in the CREATING YOUR CUSTOM SOFTWARE STARTUP chapter and elsewhere in this manual. For example, System One at a master unit could be started with the command

```
S1 /T6 /C2 /A6 /R96 /L <Enter>
```

This would cause System One to load with a data communications timeout of six seconds, using COM2: as the serial port for remote operation, with six attempts to be made in obtaining a correct packet before displaying an error message, reserving 96 kilobytes of memory for operations under DOS and XDOS, and loading the last test file (APLAST\$.TST) which was in use when the software was last QUIT in the current disk directory. Note that a space is required between each of multiple command line options.

22.11. Error Messages

If the master needs to attempt a transmission more than a specified number of times, the computer “beeps” and an error message is indicated at the bottom of the screen of the master computer. Even though the error message is given, the master will continue attempting to achieve correct communication until any key is pressed by the operator. The error message will be periodically updated to show the number of attempts which have been made. If the operator presses any key, the system will stop making attempts and the test will be aborted if the problem developed during a test. If the problem developed while the master unit was in panel mode, the system will display another error message but continue to attempt to obtain readings data from the slave until the operator goes to the

menu or disables the REMOTE selection on all panels. *After the data communications problem has been corrected, a Util Restore menu command must be sent to up-date the slave unit to the settings status specified by the master.*

The number of attempts which the master will make before displaying or updating the error message is controlled by the /A command line option. The default value is four.

22.12. Creating, Running, Viewing, and Editing Remote Test Files

Test files set up for use at the Master location will have REMOTE selected in the top border of one or more of the GENERATOR, ANALYZER, DCX, DSP, and SWITCHER panels. An additional menu action, Run Remote, is required to enable the system to run REMOTE tests with a full system connected including modems, data communications link, and a distant computer and System One or serial interface System One. Unless a full remote system is connected and operational, executing Run Remote and selecting REMOTE or loading a previously-created xx.TST file with REMOTE selected on a panel will result in system delays and timeout errors. Thus, unless a full remote system is connected, creating tests for use at a master location or viewing or editing such tests, should be done only after the Run Local command is executed. System One normally loads into the Run Local mode.



23. EQUALIZATION

23.1. Equalization Concepts and Applications

The computer and software base of System One makes it possible to provide the powerful feature of generator equalization. This capability enables the generator to sweep through a specified frequency range while producing any desired, arbitrarily furnished amplitude function instead of the usual flat response with frequency. The equalization function can be any of a number of standard files furnished with System One such as RIAA or inverse RIAA phono equalization, or pre-emphasis or de-emphasis at any of several industry-standard time-constant curves. The equalization function can also be created by table entry, with the user typing in the desired data from information in a reference curve or table in the literature. System One software performs a log-log interpolation between the data points of the equalization file.

The equalization curve can be measured data or an inversion of measured data. Thus, System One can measure the frequency response of any linear device under test, normalize and invert that response with simple menu-selectable utilities, attach the resulting curve to the generator, and then produce a flat output from the device on succeeding sweeps since the generator creates an equal but opposite function at the device's input. This feature is extremely useful in applications such as testing equalized power amplifiers at their rated power output across their bandwidth, in testing systems such as fm and tv transmitter audio channels which include pre-emphasis but should be tested at constant modulation percentages, in calibrating out even the minor variations from perfect flatness of System One itself, and (assuming that a reference flat microphone is connected to the analyzer input) in calibrating acoustical chambers and "artificial voices" used in acoustical testing.

Generator equalization makes use of the SINE and EQSINE selections of generator waveform, of the .EQ file type and the Save EQ and Load EQ file handling utilities, and of the Names GEN-EQ, Compute Normalize and Compute Invert menu commands. A BASIC program and a System One procedure which calls it are also furnished which can create an equalization file from a user-supplied algebraic equation. New .EQ files can be created by use of EQCREATE.PRO, which calls a BASIC program called EQCREATE.BAS.

23.2. Using Furnished EQ Files

To cause a generator sweep equalized by one of the .EQ files furnished with System One software, use Names GEN-EQ with the cursor control keys and <Enter> key to attach one of the furnished .EQ files. You can double-check via the NAMES panel that the desired .EQ file is attached. Select EQSINE as the generator waveform, and a new label and field called POST-EQ will appear (following a moment's computation) immediately under the AMPLITUDE field near the top of the generator panel; see Figure 23-1 for an example. Varying the generator frequency with FREQSTEP or by direct entry will

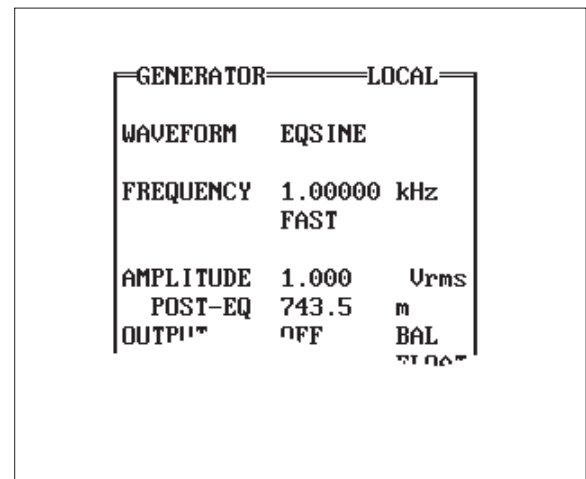

Figure 23-1 Generator Panel with EQ Active

show the POST-EQ amplitude (actual amplitude requested from the generator) varying from the panel-entered AMPLITUDE according to the attached equalization function.

Depending on the selected AMPLITUDE, on the generator output configuration (BAL, UNBAL, or CMTST), and on the value of the attached equalization curve at the selected frequency, an error message will result if the requested POST-EQ amplitude is outside the generator's capability. If the SWEEP (F9) DEFINITIONS panel is properly set up for a frequency response sweep, pressing <F9> will result in a measurement which includes the effects of the equalization file. The <F7> and <F9> keys can be used, changing the GENERATOR panel from SINE and EQSINE between the sweeps, to see response with and without the generator equalization. At frequencies between the data points in an attached equalization file, System One software will perform a log-log interpolation to compute the value to which to set the generator amplitude.

Equalized sweeps will run fastest when the direction of frequency change (high to low, or low to high) of the .EQ file matches the sweep direction of the .TST file it is used with. Speed is also maximized by having the smallest number of points in the .EQ file which will produce an equalization function of the desired accuracy. If it is desired to change the frequency end points of a supplied .EQ file, to change the number of points in the file, or to reverse the direction of frequency change in the file to match the frequency sweep direction of a particular .TST file, use EQCREATE.PRO and EQCREATE.BAS (see below) to create new .EQ files as desired. When a .TST file with .EQ file attached has been loaded, starting a sweep (<F9> or <F7>) will cause the system to load the .EQ file (up to the first 200 points) into memory for maximum testing speed. If an equalization file with more than 200 points is required, test operation will slow markedly as the test progresses into the frequency region

Hz	V	OFF
15000.000000000,	1.000000000	
50.000000000,	1.000000000	

Figure 23-2 Equalization File for Gated Sweep

beyond 200 points since it then must access the disk-stored .EQ file for data. This 200 point restriction assumes that S1.EXE software was loaded in the simplest fashion, so that normal memory space allocation procedures were followed. It is possible to load S1 such that much larger (or smaller) .EQ files will load into memory. See the Controlling Memory Usage section of the CREATING YOUR CUSTOM SOFTWARE START-UP PROCESS chapter for more details.

If the SWEEP (F9) DEFINITIONS panel is set to produce a sweep which begins and/or ends outside the frequency limits of the attached equalization file, the generator amplitude will be reduced to zero when the sweep frequency is outside the end points of the equalization file. This capability may also be used when it is desired to produce a gated sweep, even without equalization. An .EQ file can be simply created in Edit Data mode, consisting of the two desired end points for the gated-on portion of the sweep in the first column and the value 1.0 for amplitude at those points in the second column; see Figure 23-2 for an example which would produce a gated-on sweep only between 15 kHz and 50 Hz. With this .EQ file attached, EQSINE selected, and the SWEEP (F9) DEFINITIONS panel set for a sweep over still-wider limits such as 30 kHz to 20 Hz, the result will be a flat-amplitude sweep between 15 kHz and 50 Hz (actually, between the first and last steps computed between those limits according to the # STEPS and LOG/LIN selections made) with no generator output prior to or following that portion of the sweep. This is a useful capability to produce a test tape or other recorded signal for use with System One's EXTERNAL sweep mode. When played back, the recording output level will be below the EXT MIN LVL amplitude selected on the SWEEP SETTLING panel until the gated-on portion of the recorded sweep is reached, providing easy synchronization between System One and the tape player.

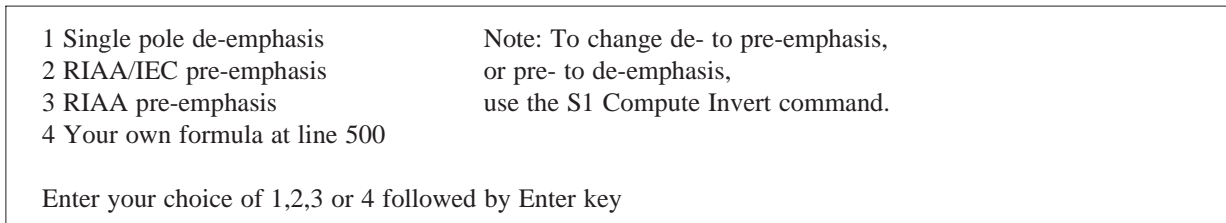

Figure 23-3 Menu Screen, EQCREATE.BAS

23.3. Creating Equalization Files from Formulas

The procedure EQCREATE.PRO and the BASIC program EQCREATE.BAS are furnished on the "Test and Utility" diskette for creation of customized equalization files. These utilities allow the generation of RIAA phono equalization curves (with or without the IEC amendment) and single-pole pre-emphasis curves with any desired time constant via built-in formulas. They also support generation of an equalization function from any algebraic formula the user wishes to insert into line 500 of the BASIC program.

Running EQCREATE.PRO and EQCREATE.BAS is described in some detail in the text file EQCREATE.TXT, which may be loaded as a comment file and read on-screen with System One's Edit Comment capability (L C EQCREATE.TXT <Enter> E C). A brief discussion of the usage of these utilities is given here.

The actual computation and data creation is done by the BASIC program EQCREATE.BAS, which requires that a compatible version of IBM BASICA or Microsoft BASIC be on your computer in the same disk directory with the System One software (or in a directory in the DOS path). For BASICA and this program to run, 96 kilobytes of memory must be set aside when S1 is started instead of the usual default value of 32 kilobytes. To accomplish this, S1 must be started from DOS with the command

```
S1 /R96 <Enter>
```

From the menu, load and run the procedure EQCREATE.PRO by the keystrokes

```
<L>< P> EQCREATE <Enter><R>< P>
```

Assuming that BASICA, EQCREATE.PRO, EQCREATE.BAS, and EQCREATE.EQ are all in the default directory or the DOS path, you will see a screen as shown in Figure 23-3.

If you do not see this screen message, it is probably due to insufficient memory being set aside for BASIC operation, or to BASICA or the program EQCREATE.BAS not being found by DOS. Both BASICA.COM and EQCREATE.BAS (plus EQCREATE.EQ, for the following steps) must either be located in the same directory with EQCREATE.PRO, or in a directory specified by the DOS PATH command at computer start-up.

If you select option 1, you will receive additional prompts for the equalization time constant in microseconds, the start and last frequencies, and the number of data points to be computed. Options 2, 3, and 4 will ask for the start and last frequencies and the number of points. Note that the frequencies must be supplied in Hertz; the BASIC program does not recognize the "k" notation for kilo- as does System One software. You will then see the function being computed in tabular form on the computer screen. If the tabular data appears satisfactory, press <Enter> and the data will be saved under the file name EQCREATE.DAT. A message will then appear to validate whether the program has functioned properly to this point. Pressing <Enter> will cause control to pass from the BASIC program back to System One, which will ask for the horizontal value (frequency) at which to normalize the data. One kilohertz is the value typically used. System One will then graph the equalization curve for your inspection. After inspection, press <Enter> or <Esc> and System One will ask for a file name under which to save this equalization file. Supply an appropriate name, followed by <Enter>.

To convert any pre-emphasis curve to a de-emphasis curve or vice-versa, load the appropriate equalization file, use the Compute Invert function, and save the newly inverted curve under another file name. For example, if you have created a 20-point RIAA pre-emphasis curve via EQCREATE.PRO and saved it under the name RIA-PR20.EQ, you can create and save the companion de-emphasis curve by the keystroke sequence

```
<L> < E >RIA-PR20.EQ <Enter>
```

(Load EQ RIA-PR20.EQ)

```
<C>< I>< S>< E> RIA-DE20 <Enter>
```

(Compute Invert Save EQ RIA-DE20.EQ)

Selecting option 4 in EQCREATE will generate a function according to the formula in line 500 of the program EQCREATE.BAS. The formula

$V=1000/W$ (where W is the angular frequency in radians per second)

is supplied in line 500 as an example. Another formula is easily substituted by use of System One's Edit Comments capability. Load EQCREATE.BAS into the comments editor and view the program via

```
<L> < C> EQCREATE.BAS
```

(Load Comments EQCREATE.BAS)

```
<E> < C>
```

(Edit Comments)

Use the arrow keys or <Ctrl><PgDn> to move to the end and substitute your own formula in line 500. Pre-defined variables include

V (amplitude in Volts)

F (frequency in Hertz)

W (angular frequency in radians/sec)

X (angular frequency squared)

Save the revised program under the same file name by

```
<S> <C> <Enter> <Y>
```

(Save Comments; the system will have retained the name EQCREATE.BAS from when the file was loaded, so pressing <Enter> will initiate saving the modified file. Since the file name already exists, the system will ask your permission to over-write, which you give with Y for yes.)

You may now run EQCREATE.PRO, select option 4, provide the desired start and stop frequencies and number of points, and save the equalization file.

23.4. Entering and Editing Equalization Files

If a tabular listing is available of a desired equalization curve (or a graph from which you can read and interpolate data), you can create an .EQ file in the Edit Data mode. It may be simplest to first use Load EQ to bring into memory one of the standard files furnished with System One, since the format and column headings will thus be guaranteed correct. You may then overtype or insert as desired to change or replace the data points with those you wish to create, and Save the resulting EQ file under an appropriate new name.

23.5. Creating EQ Files from Measured Data

To create an equalization file from measured data, you must first use or set up a test to measure the frequency response of the device which will be the basis for the curve. Be sure the settling algorithm is tight enough to guarantee settling to the desired accuracy, and that a sufficient number of points are selected for the frequency sweep to provide the desired amplitude accuracy when the system later performs its log-log interpolation between data points. Run the test and store the results under an appropriate .TST file name.

It is usually most convenient when the equalization curve has a value of unity at some mid-band frequency (typically 1000 Hz) so that the generator output level will be unchanged as you change back and forth between SINE and EQSINE with the generator at that frequency. To accomplish this, use the Com-

pute Normalize menu command. The system will ask you for the horizontal value at which to normalize the data; if 1000 Hz is the desired value, enter 1000. You may graphically re-examine the data after this normalization with the <F7> key if you wish.

If the desired equalization curve is the inverse of the measured response, as it will be when the desired end result is flat response at the output of the system even though the system has a non-flat response, the curve must now be inverted. This is accomplished with the Compute Invert menu command. A message in the lower left of the screen will indicate that the inversion is taking place, and the result can be examined with the <F7> key. Assuming that it is satisfactory, use Save EQ to save the data as an equalization file. It may now be attached to any test via the Names GEN-EQ menu command as described above, EQSINE selected as the test waveform, and the resulting test saved.

One useful application of this capability is providing even better flatness than the specified flatness of System One, for highly critical measurements. This can be particularly valuable at frequencies above 50 kHz, or even beyond 100 kHz where flatness is not specified. Connect the generator output to the analyzer input with the cables, source impedance, and load impedance which will later be used to test external devices.

Specify extremely tight settling conditions on the SWEEP SETTling panel, such as DATA SAMPLES of 4 or more and a TOLerance of 0.1% (0.01 dB). You may wish to change from EXPONTL to FLAT to force all specified consecutive measurement samples to agree within the selected TOLerance before the generator steps on. Selection of the AVG, rather than RMS detector on the LVF1 panel will also improve system flatness slightly. Resolution, and therefore flatness, above 80 Hz may also be improved (at the expense of test time) by selecting 4/sec or 8/sec instead of AUTO on the DETECTOR line of the LVF1 panel. Run the test, use Compute Normalize and Compute Invert as described above, and Save the EQ file under an appropriate name. Attach it to the test with the Names GEN-EQ command and select EQSINE. Succeeding test runs should produce extremely flat response,

limited only by noise, thermally induced drift, and other "repeatability" factors. The system may now be connected to the device to be tested with the same cables and the actual tests made.



24. ACCEPTANCE TEST LIMITS

In many applications such as production test, incoming inspection, and quality assurance, it is desirable to establish a definition of acceptable performance levels for a product. Test results can then be compared to those acceptable levels and a pass/fail or go/no-go decision can be made. System One supports this mode of operation via a limits and comparison capability which uses the Names Upper, Names Lower, Names Error-file, and Names Off menu commands and an If Error[statement in a procedure. The Edit Data capability is normally used to help create the limit files.

A defined limit (or pair of limits, if both upper and lower limits are used) is normally created as a limit file (xx.LIM file type), though xx.TST and xx.SWP files are identical in format and could be used. It is possible to either create such a file from the beginning, to make a measurement or average a number of measurements of actual devices as the basis of a limit, or to start with an actual device measurement and then further edit it into the desired form as a limit file. When the file has been created, it can be attached to a test file via the Names menu command.

24.1. Creating A Limit File

As an example, let's assume that we need to create a file to be used as an upper limit in a distortion versus frequency test, and that acceptable performance is defined as 0.01% between 100 Hz and 10 kHz, with permissible degradation to 0.02% from 20 Hz to 100 Hz and 0.05% from 10 kHz to 20 kHz. First, set the sweep definition panel for a five-step frequency sweep from 20 kHz to 20 Hz, with RDNG (THD+N from the ANALYZER panel) selected as the DATA-1 value and DATA-2 set to NONE. Press <F9> to run this test; at the completion of the graph or table, press <Esc> Edit Data, which will move you into the data buffer. Go into

Hz	%	OFF
20000.0,	0.05,	
10000.0,	0.05,	
9999.9,	0.01,	
100.0,	0.01,	
99.9,	0.02,	
20.0,	0.02,	

Figure 24-1 Example Limits File

the overtyping mode by using the <Ins> key. Then, modify the data as necessary to look like Figure 24-1.

Commas *must* be used to separate the numeric entries; spaces can be added between the columns for readability. Column heads in the proper units (as shown on the panels or tabular displays) are required, and the third column must be headed Off if no DATA-2 parameter will be specified in the test file.

Use <Esc> to go back to the top menu. You may view the limit file graphically by pressing <F7>. To save the limit file to disk, press Save Limit and supply some easy-to-remember name such as DIST-UP. The system will automatically add the xx.LIM extension.

When a simple horizontal limit file is desired, with the same limit at all values of the independent variable, only one data row need be entered in Edit Data mode. The limit value in the second column will then be applied across the entire range tested. Figure 24-2 is an example of a 0.5% distortion limit at all frequencies; the specific frequency entered in

Hz	%	OFF
20000.00000000,	0.50000000,	0.00000000

Figure 24-2 Example Single-Point Limits File

It is important to understand when working with limit files and test files that *only one section of memory exists in System One software for setup information and binary data, whether the file is a .TST file, .LIM file, .EQ file, .SWP file, or .OVL file. Whichever of those files is loaded by the LOAD command displaces the last file of any of these types in memory. Only the file in memory can have its panels shown in PANEL mode, only that file's data will be displayed by <F7>, and only that data can be edited in EDIT DATA mode.* Assume, for example, that you have loaded a .TST file in order to attach limits to it and experiment with the test. If you decide to change the limit, Load Limit and the limit file you load will replace the .TST file in memory. After you have modified and re-saved the limit file, you must again Load Test and press <Enter> to bring the .TST file back into memory. When you select Load Test, the system will suggest the name of the last test file which was loaded and you can load it merely by pressing <Enter>. You must take this action to load it, however, since it was removed from memory when the limit file was loaded.

24.3. Creating Limits Files By Actual Tests

When it is desired to use the measured data from a "golden unit" (a perfectly representative sample) as a limit file, the Compute Normalize and Save Limit commands can be used with test data run on the golden unit. Compute Normalize can offset the curve by any desired amount. The curve can thus be offset upwards and the result saved as an upper limit. Compute Normalize can then be used again to offset the curve downwards and this result saved as the lower limit.

24.4. Running Tests With Limits

When measurements are made at values of the independent variable (horizontal axis) which fall between data points in the limit file(s) in use, interpolation will be made between the two "bracketing" limit points to obtain a limit number for comparison. *Log-log interpolation (logarithmic on both horizon-*

tal and vertical axes) will be used if both limit file points are positive values. If either limit file point is zero or negative, lin-lin interpolation will be used. The values in limits files must be arranged monotonically; that is, in continuously increasing or continuously decreasing order, with no reversals. Maximum testing speed will occur if the limits file and the test file proceed in the same direction. If it is desired to see any errors indicated while the test is in process, the test must specify DISPLAY TABLE rather than graphic form. If the data is displayed graphically, however, the comparisons will still be made and an error file will still be generated.

It is also possible to show the limits graphically on the screen and then plot test data onto the same screen. With VGA and EGA color displays, the limit(s) will graph in a different color from the data. Displaying any attached limits is done by pressing <Alt><F7>. Only the first 200 points of a limit file (the memory-resident portion) will graph when <Alt><F7> is pressed. The test is then run as usual by pressing <F9>. If the sweep-erase-repeat cycle of testing is desired (typically for making adjustments), the keystroke sequence <Alt><F7> <Alt><F8> <Alt><F9> will graph the limits, store them in video memory, and then run the repeating sequence. Note that sweep-erase-repeat does not function if S1.EXE was started with the /8 DOS command line option to conserve memory.

The error file is an ASCII file and can be displayed via any editor, or printed to an attached printer via the usual DOS commands. A file used as a limit must either be in the same disk directory as the file using it, or its location must be identified with a specific path name.

When a sweep is initiated (F9, F7, etc.) with a test file which has limit files attached, System One will load the limit file(s) into memory up to the first 200 points (if standard memory allocation was used at start-up). This helps tests with limits attached to run almost as rapidly as those without. If limit files larger than 200 points are used, the computer must access the disk-stored limit files and operation will slow down markedly. See the TESTING SPEED chapter for more details. It is possible to specify

much larger numbers of points to automatically load into memory. See the "Controlling Memory Usage" section of the CREATING YOUR CUSTOM SOFTWARE START-UP PROCESS chapter, on page 28-5, for more details.

24.5. Master Error Files

A given error summary file may be attached to more than one test file by using the Names Error-file command on each xx.TST file as it is created. When tests are run, new error data is appended to any existing data in the named error file, rather than replacing it. It is thus possible to run a sequence of tests (see the PROCEDURES chapter following) in which many or all of the tests name the same error file. The result will be an error file listing every deviation from limits for the entire sequence of tests. Even a test which is successfully passed with no out-of-limits measurements will produce a three-line listing in the error file, including the name of the test, the date and time it was run, the column heads showing the measured parameters and the independent variable, and a message stating that all values were within limits. An error file can thus become the master test record, showing all deviations and all tests for which no deviations occurred. Since the appending process will go on indefinitely, you will normally wish to begin the procedure with a DOS command which erases the existing error file for a clean start. Using the example file name from the preceding paragraph, the line in the procedure could be:

```
DOS ERASE ERRSUMRY.TXT/R
```

If it is desired to temporarily "disconnect" the error file while a test is run, the Names Off command can be used. This is normally necessary when the Compute command will be used to process raw data before decisions or actions based on limit comparison. In these cases, the error file should not be written into until after the Compute operation. After Compute Xxxxx, the error file can be re-connected via Names Error-File <Enter>. An F7 operation will then compare the adjusted data to the limits and write the appropriate message into the error file. In a procedure (see next chapter), the sequence would be:

```
LOAD TEST testname/R
NAMES OFF
/F9/E
COMPUTE XXXXXX
NAMES ERROR-FILE/R
/F7/E
```

25. PROCEDURES

A procedure, in System One terminology, is a file which executes an entire series of tests and other necessary actions in a specific order. The procedure may include:

- loading and running xx.TST files (with or without upper and lower limits and error-message files attached)
- calling and running sub-procedures
- branching to different procedures or different portions of the same procedure, depending on whether the preceding test contained any out-of-limits measurements
- branching dependent upon which keyboard number key the operator presses, permitting construction of menus
- jumping to any arbitrary point, or looping
- changing setup panel fields of a test
- making prompting messages to an operator
- controlling an external device via the PORT OUT capability of the DCX-127, a spare parallel (printer) port on the computer, or a purchased interface card
- delays and pauses between steps
- issuing DOS commands to erase files, change sub-directories, run other programs, and accomplish actions such as data print-out or file management.

Procedures are particularly useful in production test and quality assurance applications, so that a non-technical operator can perform complete tests on an item to standards established by the Production Test Engineering or Quality Assurance departments. Procedures are also highly useful in the Engineering laboratory for any repetitive testing such as performance measurements during environmental tests or

for evaluation of multiple samples of components, and for quick checkout of devices in Maintenance shops.

25.1. Loading and Running Procedures

Previously-saved procedures may be loaded via <L> <P>, selecting the desired procedure with the cursor, and pressing <Enter>. The procedure can then be run via <R> <P>, or by pressing <Enter> twice since Run is the first item in the Command Menu and Procedure is the first item in the Run menu. Thus, after pressing <L> <P> and moving the cursor onto the desired procedure name, three consecutive operations of the <Enter> key will load and run the procedure.

If attempting to run a procedure results in the error message "Procedure Buffer Empty or Invalid", there are two probable reasons. A conflict between the S1 software version in use and the version under which the procedure was stored is the most likely reason. Whenever a procedure is created, the first line contains a reference to the software version in use (PROCEDUREv2.10, for example). If an attempt is made to run a procedure created under version 1.60 or 2.00 with version 2.10 software, the error message will result. The "Procedure Buffer Empty or Invalid" error can also result if the first line of a procedure is blank due to inadvertent use of the <Enter> key in Edit Procedure mode. This pushes the procedure header line down into the second line of the buffer. The cure is to pull the header back up into the first line with the key.

If the procedure is otherwise compatible with the software version currently in use, the cure is to simply change the version number of the procedure header in Edit Procedure mode and then re-save the procedure, replacing the earlier version.

Earlier procedures are normally compatible with later software versions except for two possible reasons:

- use of keystroke movements on the panel during the procedure
- use of any of the commands NAMES ERROR-FILE, NAMES GEN1#1-EQ, or NAMES RENAME

In the case of keystroke movements on the panel, incompatibility may exist where new fields or additional choices have been added. The section of the procedure must be replaced with a new section with the correct number and type of keystrokes. The new Panel Mnemonics feature of two-character keystrokes to jump to key panel fields may be used to replace the original keystrokes, resulting in faster operation, a more self-documenting procedure listing, and greater likelihood that future changes will not be necessary even if new panel fields are added in future software revisions. See page 25-10 for a detailed discussion of the two-character Panel Mnemonic codes feature.

25.2. Generating Procedures

Procedures may be generated in one of two fashions: by “recording” a series of key-strokes as you proceed through the set of actions which you wish to be accomplished automatically, or by using the Edit Procedure editor to create the procedure. The keystroke recording process is typically simpler and more error-free when creating a new procedure. Making small changes in an existing procedure is easily done in the Edit Procedure mode.

25.2.1. Generating Procedures by Learning Keystrokes

The keystroke recording process is both started and stopped from the Util command of the top level menu. Util Learn is the command to begin recording a sequence and Util End is the command to stop. When completed, a procedure can be run before saving it by the Run Procedure command from the top level (COMMAND) menu. After any neces-

sary de-bugging, Save Procedure will save the procedure to disk under a name you supply; the system supplies the xx.PRO file type automatically. Edit Procedure is used to examine or edit the procedure, whether it was generated by learning keystrokes or from the editor.

After starting the keystroke recording process with Util Learn, simply press the keys and type in the file names as you would when going through the same actions one step at a time. File names should be specified by explicitly typing in the name, rather than using the arrow keys and <Enter> to select a name in the displayed directory. The reason for this is that arrow key operations are recorded during Learn mode as relative movements sideways or up and down. Any additions or deletions to a directory, or changes in the beginning cursor position, will cause faulty operation of a pre-recorded arrow key sequence. Remember to use the <Esc> key as necessary to move to the top level menu before entering a menu command by pressing its first letter. Enter menu items via their first letters, rather than the space bar and <Enter> technique.

25.2.1.1. Learn Mode Procedure Example

An example is probably the best way to see how a procedure is generated. If any procedure has already been loaded into the procedure buffer, it should be deleted before starting to generate a new procedure, since the new procedure will otherwise append to the bottom of anything presently in the buffer. Use the Edit Procedure menu commands to check for existence of a procedure, and the <F6> key to mark its beginning and end for deletion if necessary.

Assume that we desire to test a power amplifier by measuring frequency response, distortion versus frequency at maximum output power, and distortion versus amplitude at a fixed frequency.

First, create a frequency response test. In Panel mode, set the generator amplitude, output configuration, analyzer units and detector type, sweep end points and number of steps, etc. Run the test to be sure it works; make any necessary changes, and

```

PROCEDUREv2.10
LOAD TEST RESPONSE/R
/F9/E
LOAD TEST THDVSFRQ/R
/F9/E
LOAD TEST THDVSAMP/R
/F9/E
UTIL END

```

Figure 25-1 Keystroke-Generated Procedure Listing

Save the Test as (for example) RESPONSE.TST. Similarly, set up the panel for a distortion versus frequency sweep and save it as THDVSFRQ.TST. Create a panel for a distortion versus amplitude sweep at a constant 1 kHz, and store it as THDVSAMP.TST. You are now ready to create the procedure.

Use <Esc> to go to the menu. To erase any procedure in the procedure buffer, press <E> <P> for Edit Procedure. Use the <Ctrl><PgUp> keys to move to the top of the buffer. If any text is in the buffer, use the <F6> key to eliminate it. When the buffer is empty, use the <Esc> key to go to the menu.

Press the keys <U> <L> for Utility Learn. The name of the menu (COMMAND in the case of the top level menu) will change appearance to indicate that the system is learning your keystrokes. Press the keys <L> <T> for Load Test. Type in the test name RESPONSE, followed by the <Enter> key. Do not use the cursor to select RESPONSE.TST from the directory on screen, but type in the explicit name. It is not necessary to add the .TST extension. Press the <F9> key to run the test. It is not necessary to wait for the test to run; press <Esc> to return to the menu. Press the keys <L> <T> for Load Test, and type in the test name THDVSFRQ, followed by <Enter>. Press <F9> and <Esc>. Press <L> <T>, type in THDVSAMP, and press <Enter>. Press <F9> followed by <Esc>. To halt the keystroke learning process, press <U> <E> for Utility End. The name of the menu will stop flashing.

To see the results of the keystroke learning process, press <E> <P> for Edit Procedure. You should see a listing similar to Figure 25-1. Note that the

system automatically performs a number of actions to make the procedure listing more readable; the complete command LOAD TEST is written out, for example, even though only the keys <L> <T> were pressed during creation of the sequence. /R is inserted for an operation of the <Enter> (<return>) key, and /E for the escape key. The header is automatically generated by the Util Learn command. Line feeds are inserted for readability.

To save this procedure to disk, <Esc> Save Procedure and supply an appropriate file name. To run the procedure, <Esc> Run Procedure. You should then see all of the actions which you entered proceed in order, with each test being graphed or presented in tabular format, as set up in each test.

25.2.2. Creating or Modifying Procedures in Edit Mode

Some people may prefer to create the entire procedure by typing in the commands, rather than using Util Learn mode. Procedures created in Learn mode may require corrections and modifications, which are usually most easily done in Edit Mode.

To edit any procedure, load it via Load Procedure and select Edit Procedure to display the contents in the procedure editor. Operation of the editors is described in the MENUS chapter, and the Help Edit function lists the control keys useful in this mode. Upper-case versus lower-case characters are not important in a procedure.

Figure 25-2 shows in the first column how various commonly-used keys are represented in Edit Procedure mode. The second column shows how they are shown in this manual text, and the third column briefly explains their function.

Certain keyboard codes cannot be generated in Edit mode by pressing a single key, but may be generated in Util Learn mode. These include keystrokes such as produced by the <Ctrl><Home> keys, key, <PgUp> key, etc. You can use Util Learn to start learn mode, press each of the necessary keys in order, stop learn mode via Util End, and then use the <F6> and <F5> “cut and paste” ca-

Procedure Listing Appearance	Manual Text Representation	Function
/F10	<F10>	Pause
/A9	<Alt><F9>	Run sweep, erase repeating test
/C9	<Ctrl><F9>	Run test without erasing previous dat
/F9	<F9>	Run test
/S9	<Shift><F9>	Run external test, terminate on reversal to generator panel frequency
/A8	<Alt><F8>	Store graphic image of screen
/F8	<F8>	Display stored graphic image
/A7	<Alt><F7>	Graph limits
/F7	<F7>	Re-graph data in memory
/F6	<F6>	Re-transform (DSP only)
/A6	<Alt><F6>	Re-send data to PC without new transform (DSP)
/F4	<F4>	Set analyzer dBr reference
/A4	<Alt><F4>	Set analyzer relative frequency reference
/F3	<F3>	Set generator dBr reference
/A3	<Alt><F3>	Set generator relative frequency reference
/C3	<Ctrl><F3>	Initiate one REGULATION cycle
/F2	<F2>	Display bargraph
/A1	<Alt><F1>	Abort procedure without turning generator off
/F1	<F1>	Turn off generator and abort procedure
/E	<Esc>	Go to command menu
/R	<Enter>	
*	<*>	Dump screen to printer

Figure 25-2 Special Keystroke Appearance in Procedure Listings

pability in Edit Procedure mode to move and copy these keystroke symbols to the desired locations. Alternately, some ASCII text editors (but not Edit Procedure mode) can generate these keystrokes by holding down the <Alt> key while entering via the numeric keypad a two or three digit number which represents the ASCII code for the particular symbol. The first column of Figure 25-3 shows a number of the graphic symbol representations. The second column shows which keystrokes in Util Learn mode these symbols correspond to. The third column shows the ASCII code whereby they may be entered in ASCII text editors, while the last column briefly describes their function.

25.3. Adding to Existing Procedures

Additions to an existing procedure may be made by learning keystrokes or in edit mode. Additions by learning keystrokes can be made with Util Learn, the keystrokes, and Util End; this will append the new information to the end of the procedure presently in the Edit Procedure buffer. You can then use Edit Procedure to delete the UTIL END from the original procedure and the header inserted by the latest Util Learn command. If the new addition is to be located somewhere other than at the end of the existing procedure, use <F6> to remove the new addition to the delete buffer, then move the cursor to the desired place and copy the new addition back

Screen Display	Learn Mode Keystroke	ASCII Editor Keystrokes	Function
↑	<up arrow>	<Alt>24	cursor up
↓	<down arrow>	<Alt>25	cursor down
←	<left arrow>	<Alt>17	cursor left
→	<right arrow>	<Alt>16	cursor right
␣	<Ctrl><Home>	<Alt>235	panel cursor to ref. position
␣	<Home>	<Alt>187	panel cursor to top
␣	<End>	<Alt>195	panel cursor to bottom
␣	<PgDn>	<Alt>197	next set of panels
␣	<PgUp>	<Alt>189	last set of panels
␣	<Ins>	<Alt>198	insert mode (toggle to overtype)
␣		<Alt>199	decrement value
+	<+>	<Alt>43	increment value
*	<*>	<Alt>42	screen dump print-out
␣	<Ctrl><right arrow>	<Alt>232	right end of mult. choices
␣	<Ctrl><left arrow>	<Alt>231	left end of mult. choices
␣	<Ctrl><PgDn>	<Alt>234	bottom of editor
␣	<Ctrl><PgUp>	<Alt>248	top of editor
␣	<Alt><P>	<Alt>141	punch out present field
␣	<Alt>	<Alt>164	blank all panel fields
␣	<Alt><R>	<Alt>128	restore all panel fields
␣	<Alt><A>	<Alt>146	increment overlay video attribute
␣	<Alt><S>	<Alt>147	decrement overlay video attribute
␣	<Alt><Z>	<Alt>160	set overlay video attribute to zero

Figure 25-3 Screen Appearance of Keystrokes Which May Be Used in Procedures and Macros

from the delete buffer with the <F5> key. The header and UTIL END from the addition can be deleted after it is moved.

If you add portions of a procedure in the Edit Procedure mode rather than via keystrokes, remember that you must explicitly type /R wherever you want the <Enter> key action to occur, such as when entering a file name. Pressing the <Enter> key while in Edit Procedure mode simply starts a new line in the listing, but will not be interpreted as an <Enter> action when the procedure runs. If you delete portions of a procedure in Edit Procedure mode, remember that the first line must always remain PROCEDUREv(x.xx), where (x.xx) is the System One software version. If the first line is blank or contains other data, an error message will be obtained when attempting to run the procedure.

Anything inserted after a semi-colon (;) on a line will be ignored when a procedure is run. The person creating the procedure can thus add remarks to

help him or someone else to later understand just what the procedure does. Note that System One software's interpretation of the semi-colon means that a semi-colon may not be used as part of a Util Prompt or Util Message, since nothing following it on the same line will be displayed or printed.

25.4. Program Flow Control

The basic flow of a System One procedure is linear, from top to bottom. Each line in the procedure will be executed in order unless flow is diverted by another command such as UTIL GOTO, RUN CALL, RUN EXIT, LOAD PROCEDURE, or an IF statement.

```

PROCEDUREv2.10
: STARTHERE/R
LOAD TEST firstest/R
/F9/E
UTIL GOTO starthere/R
UTIL END

```

Figure 25-4 Procedure for Continuous Loop

25.4.1. Jumping to Another Location: UTIL GOTO

The Util Goto statement followed by a line label will cause procedure flow to jump to the line carrying that label. A label in a procedure is indicated by the colon (:) symbol at the beginning of the line, followed by the label (name) and the /R symbol for <Enter>. *The /R following the label name is critical.* Thus, a procedure as shown in Figure 25-4 will run in a continuous loop. After loading and executing the test, the Util Goto line will cause it to jump back to the STARTHERE label and repeat forever.

25.4.2. Conditional Branching: IF

To permit change of procedure flow depending upon a test passing or operator keyboard input, the IF commands are part of System One's procedure "language".

Four IF commands will cause conditional action depending upon how all measurements of the immediately-preceding test related to any LIMIT files attached to that test. These four IF commands are IF ERROR[, IF NOTERROR[, IF ABOVE[, and IF BELOW[. Note that all IF statements have the square bracket ([) as their last character. There cannot be any spaces between the last alphabetical character and the bracket. The conditional action statement must then be terminated by a left-facing square bracket (]). For example:

```

LOAD TEST xxxx/R
/F9/E
IF ERROR[ UTIL GOTO DIAGNOSTIC/R ]

```

where DIAGNOSTIC might be the line label of another section of the procedure which loads a test to help the operator diagnose the source of the problem.

25.4.3. Conditional Branching Upon Operator Input

An additional set of IF statements permits an operator keyboard input to control the procedure flow during execution. This capability allows the construction of menus within a System One procedure, simplifying use of procedures by less-experienced operators. These IF statements are the ten commands from IF 0[through IF 9[. As with the other IF statements, the square brackets must surround the portion describing the conditional action, and the leading bracket cannot have any space between it and the numeral.

The <Ctrl><F10> keystroke (/C10 in the procedure editor) creates a pause in the procedure, waiting for operator input. Any key other than the ten numeral keys will be ignored. Any number key pressed causes the procedure flow to jump to the statement inside the square brackets of the IF n[statement corresponding to the number key pressed.

A simple example of use of this technique might be:

```

UTIL PROMPT/R
DID RED INDICATOR ILLUMINATE?
PRESS 1 FOR YES, 0 FOR NO/C10/E
IF 0[ UTIL GOTO FAILURE/R ]
IF 1[ UTIL GOTO SUCCESS/R ]

```

SUCCESS and FAILURE would be line labels for different portions of the procedure which will be executed depending upon the operator's observation of the indicator and consequent keyboard input.

25.4.4. Sub-Procedures

The procedure flow described in the two preceding simplified examples used the UTIL GOTO statement to jump to another portion of the procedure; they ignored what might happen after that portion was executed. A common requirement is for condi-

```

PROCEDUREv2.10
LOAD TEST 1/R
/F9/E
RUN CALL PRINTERR/R
LOAD TEST 2/R
/F9/E
RUN CALL PRINTERR/R
LOAD TEST 3/R
/F9/E
RUN CALL PRINTERR/R
UTIL END

```

Figure 25-5 Main Procedure to Accomplish Testing (Against Limits)

tional action to be taken, but for the program flow to then return to the point immediately after the conditional action was requested. The RUN CALL and RUN EXIT commands allow this sub-procedure flow.

RUN CALL, followed by a sub-procedure name and <Enter>, causes the named sub-procedure to be loaded and executed. A sub-procedure is identical to any other System One procedure except that it must contain a RUN EXIT statement following its other actions. The RUN EXIT statement jumps control back to the calling procedure at the point immediately following the RUN CALL statement which called it. A sub-procedure must have a UTIL END statement as their final line, following the RUN EXIT statement.

A sub-procedure may be nested, meaning that it can be called from another sub-procedure. In that case, the RUN EXIT statement in the second sub-procedure will return control to the calling point in the first sub-procedure. The first sub-procedure may then execute additional commands if desired, with control finally being returned to the main procedure when the RUN EXIT statement in the first sub-procedure is reached. Sub-procedures calling sub-procedures may be extended to a depth of fifteen sub-procedures.

```

PROCEDUREv2.10
IF ERROR[
NAMES ERR-FILE PRN/R
/F7/E]
RUN EXIT
UTIL END

```

Figure 25-6 PRINTERR.PRO; Sub-Procedure to Print Only Upon Out-of-Limits Measurements

25.4.4.1. Sub-Procedure Example: Printing Only Upon Error

In production testing applications, it is frequently convenient to print an error message only if a device fails a test. If all tests are passed, the device will be shipped. If any test fails, the resulting paper printout will be attached as a failure tag and the device will be returned to a repair station where the failure tag helps with the diagnosis.

The sub-procedure capability (RUN CALL) of System One software, coupled with several features, simplifies this process. The main procedure (see Figure 25-5) is a straight-forward process of loading each test and running the test. It assumes that each test has limit files attached, but no error file. Following the /F9/E which runs the test and returns to the menu, the RUN CALL PRINTERR/R statement calls the sub-procedure PRINTERR.PRO which will cause a printout only if any data point failed the limits.

The sub-procedure called PRINTERR.PRO is shown in Figure 25-6. Whenever this sub-procedure is called, it does nothing but return control to the main procedure if there was no error in the test just performed. If an error occurred, the IF ERROR[statement names PRN (the DOS identification for an attached printer) as the "error file", performs an /F7 to re-compare the data to limits, and prints the error file which contains out-of-limits readings along with test name, date, and time. The RUN EXIT statement (required in all sub-procedures) then returns control to the calling point in the main procedure.

```

PROCEDUREv2.10
: first/r LOAD TEST 1/R
/F9/E
IF ERROR[ RUN CALL adjust1/r
UTIL GOTO first/R]
: second/r
LOAD TEST 2/R
/F9/E
IF ERROR[ RUN CALL adjust2/r
UTIL GOTO second/R]
: third/r
LOAD TEST 3/R
/F9/E
IF ERROR[ RUN CALL adjust3/r
UTIL GOTO second/R]
UTIL END

```

Figure 25-7 Procedure to Assist Operator to Adjust Upon Failure, Then Re-Test

25.4.5. Example: Looping On Error

During production testing or maintenance activities when the device under test has adjustments available, it is often desirable to test in this sequence:

1. Test to acceptance limits
2. If device passes, move on to next test
3. If device fails, ask operator to adjust, then loop back to (1) and test again

Furthermore, it may be desirable to loop back farther than the last test when it is known that the adjustments may also have affected a still-earlier test. Figure 25-7 shows an example procedure for this type of application.

If the device passes all three tests (1.TST, 2.TST, and 3.TST), no branching will take place. If any test fails, the following IF ERROR[statement calls a sub-procedure consisting of appropriate tests, perhaps with bargraph (F2) displays and prompting messages, to help the operator perform the adjustments. When the sub-procedure is completed and flows to its RUN EXIT statement, control is returned to the calling point in the main procedure.

For this example, it was assumed that the adjustments called for by sub-procedure ADJUST2.PRO could only affect the results of test 2.TST, but that the adjustments called for by sub-procedure ADJUST3.PRO could potentially affect measurements made by both 2.TST and 3.TST. Thus, the UTIL GOTO statement inside the IF ERROR[brackets following test 2.TST loops back only to the label : SECOND, while the UTIL GOTO statement after 3.TST also loops back to the label : SECOND and will thus cause both 2.TST and 3.TST to be repeated.

25.4.6. Sub-Procedure Example: Test Menu

An example incorporating both the IFn[branching upon operator input and sub-procedures is shown in Figure 25-8. The prompt showing the test

```

PROCEDUREv2.10
: begin/r
UTIL PROMPT /R
/R
      CHOOSE DEVICE TO TEST/R
/R
/R 0. Exit Procedure/R
/R 1. MODEL 14/R
/R 2. SYSTEM EIGHT/R
/R 3. XYZ-120/R
/R 9. Quit System One software/R
/R
/R
      Press the appropriate number key/R
      to select the test./C10/E
IF 1[RUN CALL model14/R ]
IF 2[RUN CALL system8/R ]
IF 3[RUN CALL xyz-120/R ]
IF 0[util break]
IF 9[QUIT]
UTIL GOTO begin/r ;returns to menu if /R
      ;any other number selected
UTIL END

```

Figure 25-8 Procedure to Display Test Selection Menu

GW GEN Waveform	SM Settling Mode
GF GEN Frequency	SI Switcher channel A INPUT
GA GEN Amplitude	SO Switcher channel A OUTPUT
GO GEN Output OFF/ON	RE Regulation Enable
GB GEN Tone Burst duration	RM Regulation Measurement
GS GEN Amplitude step size	RV Regulation Parameter to be Varied
GR GEN dB reference	
LC Analyzer Channel Select	XU DCX DMM Units
LM Analyzer Measurement mode	X1 DCX DCV Output #1
LF Analyzer BP/BR Frequency	X2 DCX DCV Output #2
LD Analyzer Detector type	XD DCX Digital Output
LH Analyzer High pass filter	XA DCX Port A 8 bit output
LL Analyzer Low pass filter	
LO Analyzer Optional filters	DS DSP Setting 0
LA Analyzer Channel A input source	DR DSP Sampling Rate
LB Analyzer Channel B input source	DI DSP Input Type
LR Analyzer dB reference	D1 DSP Channel 1 Input Source
	D2 DSP Channel 2 Input Source
S1 Sweep Data-1 measurement	D0 DSP Output Channel(s)
S2 Sweep Data-2 measurement	
SS Sweep Source-1 stimulus	
SN Sweep Number of steps	
SD Sweep Display Mode	

Figure 25-9 Two-Character Codes to Jump to Panel Fields

menu is preceded by the line label BEGIN. Note that the line label must be followed by the /R code for <Enter>.

The menu prompt shows the three test type choices (1, 2, and 3) plus the options of 0 to exit from the procedure and 9 to quit from S1.EXE software to DOS. The <Ctrl><F10> keystroke (/C10 in the procedure listing) causes the software to pause for a number key input from the operator. The IF 1[, IF2[, and IF3[statements each call a sub-procedure which would consist of the appropriate series of tests and other actions for the device to be tested. Each of those sub-procedures must contain the RUN EXIT statement following all their other actions.

The IF0[Util Break] statement halts the procedure. The IF9[Quit] statement quits from S1.EXE back to DOS. Non-number keys are ignored. Any number key without a corresponding IFn[statement will bring the procedure to the UTIL GOTO BEGIN/R statement just before UTIL END; that statement takes the procedure back to the menu for another choice.

25.5. Changes in Panel Setup During a Procedure

When changes in panel setup are desired, it is generally preferable to create each desired setup in PANEL mode and save it as a xx.TST file before the procedure generation is begun; then simply LOAD the xx.TST file to bring in the setup. For certain applications it may be desirable to make changes in a panel setup as part of a procedure. Arrow keystrokes, space bar operations, <+> and keystrokes, and <Enter> keystrokes can be recorded in Util Learn mode, just as any other keystroke. Since the cursor position is not stored from test to test, any series of arrow keystrokes to be recorded in a procedure must be preceded with <Ctrl><Home>, which will put the panels in the normal (power-up) reference position with the cursor on the generator OUTPUT field.

25.5.1. Two-Character Codes to Jump to Panel Fields

Many of the most-used panel fields also have two-character mnemonic abbreviations which cause the cursor to jump directly to that field when typed in PANEL mode. Figure 25-9 is a listing of those abbreviations. *This same listing can be instantly displayed on screen in PANEL mode by pressing the <?> key, or is available from the menu via HELP PANEL.* The two-character method of jumping to a field is not only faster than a series of arrow keystrokes, but the resulting procedure listing is more self-documenting (easier to read and interpret). Fields which cannot be directly accessed with a two-character code can be reached by jumping to the nearest field which has a code, then using arrow keys to move to the desired field.

The most reliable selection of choices from a multiple-choice field is accomplished by first using a <Ctrl><Left Arrow> keystroke to jump to the left-most end of the selections. The <+> key can then be used to move to the selection, followed by the <Enter> key to make the new selection. This technique can guarantee that a particular selection will be made, regardless of the previous selection in that field. If only the <+> or keys are used after jumping to a field, they will create a relative change in the choices rather than an absolute choice. For example, assume that it is desired to change the DISPLAY field of the SWEEP (F9) DEFINITIONS panel to TABULAR. If this panel field was in COLOR-GRAPH mode when the procedure was generated in UTIL LEARN mode, the keystroke sequence would be <S><D> <+> <+> <Enter> (jump to Sweep Display field, change to the choice two items to the right, and select it). If this procedure is later run on a test which was in MONO-GRAPH mode, the “two choices to the right from existing choice” technique will select DISPLAY NONE. If instead the sequence learned is <S><D> <Ctrl LeftArrow> <+> <+> <Enter>, the selection will be TABULAR regardless of the previous choice, since the <Ctrl LeftArrow> will always jump the choices cursor to the beginning of the line and the <+> <+> will always move it two choices to the right.

An alternative to two-character codes or arrow keystrokes in many applications is the overlay capability described below.

25.6. Partial Loads (Overlays) to Protect Panel Fields

It is sometimes desirable to maintain certain values from one test to following tests in a procedure.

An example occurs in compact disc player testing. One track on a test disc will contain a reference level track, typically 0 dB (maximum level) at 1 kHz. Several tests may need to be referred to this level, such as quantization distortion, linearity, and S/N ratio. Each of these tests would be a separate xx.TST file, but it would be preferable to set the analyzer dBr REFERENCE value from the reference track only once and then retain that dBr REFERENCE value through the several tests.

Another example of overlay use is when desiring to make several successive types of distortion tests in a procedure on the same device, such as THD+N versus amplitude, followed by SMPTE versus amplitude, followed by DIM versus amplitude. Instead of going to the effort of setting up three separate tests with the appropriate values of impedances, frequencies, sweep limits, graphic coordinates, etc., the second and third tests could be set up as nearly-blank overlays which specify only generator WAVEFORM, FREQUENCY, and IMD frequency plus analyzer function. When these overlays load following a properly-set up THD+N test, they will leave unchanged all other parameters from the previous test.

The overlay capability of System One permits retaining earlier-established fields. An overlay file (xx.OVL) is identical to a test file (xx.TST) except that one or more fields have been “punched out”. The Load Overlay menu command functions similarly to Load Test, but shows only a directory of the xx.OVL fields in the current directory. When an overlay file is loaded, it leaves unmodified the values which the previous test had established in those “blanked” fields. An earlier-established parameter in any field can thus remain through a series of tests

MSB						LSB
Flash		Background Color		Intensity		Foreground Color
		Three Bit Color Code				Color
		000				Black
		001				Blue
		010				Green
		011				Cyan
		100				Red
		101				Magenta
		110				Brown
		111				White

Figure 25-10 Overlay Panel Video Attributes

as long as each of those tests is an overlay with the field punched out, rather than a complete test file which specifies every field on every panel.

25.6.1. Creating Overlays

An overlay file is created like any other test file, by setting all the required conditions with use of the cursor. To punch out a field so that it will not modify values established earlier in a sequence of tests, put the cursor on the field and press <Alt><P> (Punch). To restore a previously punched-out field, put the cursor on it and press <Enter>. If most of the fields on the panels are to be punched out, it will be faster to blank the entire set of panels with <Alt> (Blank), then to restore only the desired fields by putting the cursor on each and pressing <Enter>. To restore all punched-out or blanked fields, press <Alt><R> (Restore). When an overlay file has been created, the Save Overlay command must be used to save it to disk. If Save Test is attempted, an error message will result telling you that panels with one or more fields punched out can only be saved as overlays.

The Help Overlay command will display the functions of the keys used with Overlay mode.

25.6.2. Appearance of Blanked Fields

The appearance of a “blanked” or “punched-out” field depends on the type of display system used in the particular computer. It can be controlled by the user within the limits of the display system. When System One is loaded normally (by S1 <Enter>, with no V command line options), punched-out fields will be underlined on a Hercules monochrome display system, dark blue on black on an IBM color graphics system with color monitor, and dimly visible on a Compaq CGA-compatible monochrome display system. This condition is represented as number 1 (decimal) of a possible 256 conditions.

Other appearances may be preferable to individual users. On color monitors, the 256 different types of appearance are the various combinations of eight foreground colors, eight background colors, two levels of intensity, and blinking versus steady illumination. These combinations are internally controlled by an eight-bit word as shown in Figure 25-10.

For example, an intense red foreground on a black background, flashing, would be defined by the binary word 10001100 (decimal 140). Non-flashing green, normal intensity, on a magenta background would be represented as 01010010 (decimal 82).

Any desired appearance that you prefer to the normal power-up default can be selected each time you load S1. Type the command line option /V# (V stands for video) after typing S1 and before pressing <Enter>, where # is the decimal number derived as described above. To choose non-flashing, normal intensity green on a magenta background for the punched-out field appearance, for example, start System One software by typing

```
S1 /v82 <Enter>.
```

To view the various combinations on your computer, punch out several fields (or blank the entire panel with <Alt>). Then press <Alt><A> (Add) to cycle upwards or <Alt><S> (Subtract) to cycle downwards through the possibilities. <Alt><Z> (Zero) will re-set the video attribute to the decimal zero condition. This is blank on monochrome monitors and black foreground on black background on color monitors. Appearances of particular value on Hercules monochrome systems are decimal 0 (blank), decimal 1 (underline), and decimal 112 (inverse video). Appearances worth considering on a Compaq display system are 0 (blank), 3 or 4 (dim), 15 (intense), 131 or 132 (dim flashing), 135 (normal intensity flashing), and 143 (intense flashing).

25.7. Interrupting or Pausing Procedures

To pause during execution of a procedure, press the <F10> key. <F10> is a toggle; when pressed again, the procedure will resume execution. If it is necessary to abort a procedure before it is complete, the <F1> Function Key (generator off, when in panel mode) works as a procedure abort key and also turns off the generator output. If you wish to abort the procedure without turning off the generator, press <Alt><F1>. If you go into Edit Procedure mode after aborting a procedure, the cursor in the procedure editor will be at the point where the procedure was interrupted.

25.8. Prompts, Pauses, and Delays

To create a prompting message to the test operator, use Util Prompt and type in the message, terminating it with an <Esc>. For example:

```
UTIL PROMPT
SET FADER TO 40 DB AND PRESS EN-
TER KEY WHEN READY <Esc>.
```

When the procedure is executed, the message will display on the screen and the procedure will pause until the operator presses the <Enter> or <Esc> key. ***Do not use a semi-colon as part of a prompt message; the semi-colon is reserved in the System One editor to set apart remarks from the instructions which will be acted upon.***

A pause (until operator presses the <Enter> or <Esc> key) can be inserted at any desired place in a procedure by inserting an <F10> key operation. When the procedure is executed, it will pause at that point until <Enter> or <Esc> is pressed. This pause can be inserted for operator input; for example, the operator can be asked to insert a filename or other information needed by the system to continue with the procedure.

A procedure can load a test, go to PANEL mode, move to a numeric entry or multiple choice field using two-character mnemonic commands or keystrokes, and then insert <F10>. When this procedure is executed, it will pause at that point for the operator to enter a new value or choice (or signify approval of the existing choice by pressing <Enter>).

```
PROCEDUREv2.10
LOAD COMMENT NULL/R
EDIT COMMENT
TEST DATA, MODEL 123 POWER AMPLIFIER /R
OPERATOR NAME: /F10/R
AMPLIFIER SERIAL NUMBER: /F10/R
/E
SAVE COMMENT HEADER/R
UTIL END
```

Figure 25-11 Procedure for Operator Entry of Information

See the sections *Creating a Form to be Filled In* and *Storing Data in Subdirectories*, below, for examples of how pause and operator input might be used.

A specified time delay between other actions of a procedure may be created in a procedure by use of the *Util Delay* command from the menu. For example, the keystroke sequence `<U><D>3 <Enter>` will cause a 3 second delay at the point in a procedure where it is executed.

25.9. De-Bugging Procedures by Single Stepping

Like other forms of computer instructions, procedures may not always do what their creator intended and must be de-bugged. It is frequently difficult to de-bug procedures because many actions take place too fast to be observed, especially with faster computers such as AT and 386 compatibles. Procedures may be operated in a single-step mode by first starting the procedure, pressing `<F10>`, then single-stepping by repeatedly pressing `<Alt><F10>`. This will cause the procedure to be executed step by step. Information which was typed in from the keyboard, such as operator prompts and file names to be loaded, will execute character by character as `<Alt><F10>` is pressed. A procedure may be edited for de-bugging by inserting an `/F10` at the desired point to pause, after which manual `<Alt><F10>` operations from the keyboard will cause single steps. Normal procedure operation can be resumed by pressing the `<F10>` key.

25.10. Creating a Form to be Filled In

It is possible for a procedure to include a form to be filled in by the operator with information such as operator's name, serial number of the device under test, or any other desired information. The form can be saved or printed out with an error file at the end of a procedure. Such a form is created by first saving an empty Comments file, then using the *Edit Comments* capability, with pauses for the operator to fill out the items.

DATA LINE	CONNECTOR PIN
0	2
1	3
2	4
3	5
4	6
5	7
6	8
7	9
grounds	18 thru 25

Figure 25-12 Pin Connections, Parallel Port

An example will assume that the operator's name and device serial number is the data to be saved in a file which will later be printed as a header to the error file. To save the empty Comments file, first use *Edit Comments* to check whether there is currently any text in the comments buffer. If there is, delete it using the `<F6>` key. When you have an empty buffer, save it with an appropriate file name such as `NULL.TXT` by the sequence `<Esc> Save Comments NULL <Enter>`; the system will automatically supply the `xx.TXT` extension. Then, presumably at the beginning of generating a procedure in the *Util Learn* mode, create the steps shown in Figure 25-11.

The `/F10` is the indication of use of the pause key. When the procedure runs, it will pause after typing that line of the form on the screen. When the operator responds by typing in his or her name followed by `<Enter>`, the next line will be written to the screen. The `/E` after the second operator-input line takes the system back to the menu for the comments file to be saved under the name `HEADER.TXT`. The character `Y` following the `/R` (return, or enter) symbol is the necessary YES response to the system, giving permission to overwrite the existing file named `HEADER.TXT`. This will be necessary each time the procedure runs following the first time.

The remainder of the procedure then follows, including all test file loading and saving. For the example, assume that at the end of the procedure we wish to print out the header generated above, fol-

lowed by the error file which we will assume is titled ERRORS.TXT. After the last test of the procedure is run, the final steps could then be:

```
DOS COPY HEADER.TXT PRN
```

```
DOS COPY ERRORS.TXT PRN
```

The DOS COPY command, frequently used to copy files between disk directories, can also copy a file to a printer. PRN is the standard designation for the printer.

25.11. Control of External Devices

To more fully automate a test, it may be desirable to control some device external to System One during a procedure. The device under test may itself be controllable (a remotely controlled tape recorder, for example), or it may be desirable to control power to a circuit board, change the value of load resistance on a power amplifier, etc. If you have the DCX-127 module, it has three 8-bit ports for external device control. If your computer has an unused parallel port, it may be used as a control port in applications where up to eight binary lines will satisfy the need.

The addresses of the DCX-127 output ports are A, B, and C. They may be controlled in paralleled fashion from the DCX-127 software panel, or written to during a procedure from the Util Out command. See the DCX-127 chapter for more information.

The address of the parallel port (also often referred to as the printer port or Centronics port) on IBM PCs and compatibles is either decimal 888, 632, or 956. A schematic diagram of the pin connections of the parallel port is shown in Figure 25-12.

The Util Out command may be used to control the logic levels of any of the eight lines by writing the appropriate (decimal) word to the port. If your parallel port address is 956, for example, the command

```
UTIL OUT 956,0 <Enter>
```

will reset all eight lines to logic zero. To turn on the least significant bit (data 0), use

```
UTIL OUT 956,1 <Enter>.
```

To turn on the fourth-from-least and next-to-least significant bits (data 3 and data 1) simultaneously, send

```
UTIL OUT 956,10 <Enter>.
```

Eight logic lines can thus be individually controlled from a parallel port, or low-power relay coils can be driven directly from the LSTTL-compatible lines of the parallel port. If more than eight control states are required, the 8-bit word could be externally decoded to provide up to 256 states.

For more complex applications, or where no spare parallel port is available, several manufacturers make plug-in circuit cards for the IBM PC and compatibles which have relays or logic circuits controllable from the computer for interfacing with external devices. The Util Out menu command permits writing any data word to any port in the computer. Documentation furnished with the manufacturer's interface card should tell at what address the card is located, and what data words are necessary to produce the card's various output conditions.

Util Out is the one menu command which does not return to the menu level immediately after completion, in order to allow several consecutive commands in rapid sequence.

CAUTION:

Util Out must be used with caution; accidentally specifying an address port which is used by a hard disk drive or other critical component, or by System One itself, and writing to that port, could cause serious malfunction of the computer or damage to System One.

25.12. Inserting DOS Commands in a Procedure

Many functions can be performed from DOS, such as copying, erasing, moving, or re-naming files, printing to a serial or parallel printer, etc. The DOS menu command was created to let any of those commands be inserted in a procedure. An example of a DOS command could be a batch file to print an error file at the end of a procedure, then erase the error file from disk so that the same error file name can be used the next time the procedure runs. If the error file is named ERRORFIL, the batch file (created under Edit Comments or with another editor) would look like this:

```
COPY ERRORFIL.TXT PRN
ERASE ERRORFIL.TXT
```

Save this batch file under a name such as PRINERAS.BAT. Then, for the last line of the procedure, use

```
DOS PRINERAS/R
```

Running another program as part of a procedure will also be done via the DOS command. A common example would be in using an IEEE-488 interface card to control another instrument such as a dc power supply. The IEEE-488 control codes and data processing code could be written in Microsoft BASIC (BASICA). Another example would be running a BASIC program to do smoothing or averaging on an ASCII data file (xx.DAT file type) just saved from a preceding test. In either case, the test step is included in a procedure by the command

```
DOS BASICA filename/R
```

DOS commands may also be used in conjunction with operator input (during a procedure pause) required to complete the DOS command; see the section Storing Data in Subdirectories, below, for an example.

```
MKDIR C:\TESTFILE\%1
CHDIR C:\TESTFILE\%1
```

Figure 25-13 DOS Batch File to Name and Change Subdirectories

25.13. Limits, Error Files, and Data Management

Procedures will commonly be used to link a series of xx.TST files which have upper and/or lower limits attached and an error file specified. Thought must be given to how the organization using System One wishes to manage their test data during procedures. It is possible to save all data from all tests, to save all data from certain tests but not others, and to save only out-of-limits data from some or all tests. A caution is in order; it may be appealing to consider saving all test data for possible later statistical analysis, but a test system of System One's speed can amass huge amounts of data in a short time if testing is comprehensive and the unit volume is high. Even 20 megabyte hard disks can become filled in a few days at realistic unit volumes if some thought is not given to the relative utility of different sorts of data. A good solution may be to test quite comprehensively in order to assure product quality, to print on paper (but not save on disk) any out-of-limits measurements to serve as a failure tag for the people who will repair the unit to meet specifications, and to then save to disk only a limited summary of final test data on every unit for possible later statistical analysis.

As noted in the ACCEPTANCE TEST LIMITS chapter beginning on page 1, out-of-limits information is appended to any specified error file each time a test is run. A useful application of this feature is to name the same error file for every test in a procedure. At the completion of execution of the procedure, the error file can then be printed as a complete record of the unit's quality. Tests which were passed are documented by the test name, date and time of testing, and a message that all values were within limits. Since it would probably not be desirable for this error file to continuously grow by appending data from unit after unit, the procedure will

```

PROCEDUREv2.10
UTIL PROMPT/R
  PRESS <ENTER> KEY/R
  TYPE IN SERIAL NUMBER/R
  OF UNIT TO BE TESTED/R
  THEN PRESS <ENTER> KEY
AGAIN/E
DOS NEWSERIL /F10/R
LOAD TEST C:\TESTFILE\TESTSTD/R
/F9/E
SAVE TEST FINALTST/R

```

Figure 25-14 Procedure to Create Subdirectory from Serial Number

probably make use of the DOS menu command and DOS commands to erase any existing file at the beginning of a procedure.

25.13.1. Storing Data in Subdirectories

If it is desired to save test or error files on disk, but to keep the data from the tested units separate from one another, it is possible to use DOS sub-directory naming and changing commands to create a separate sub-directory for each unit tested. The sub-directory may be named with the serial number of the unit (up to eight characters); each sub-directory may then contain error files, data files, or test files with identical names to other sub-directories, identifiable by the sub-directory in which they are located. To operate in this manner, a DOS batch file (.BAT file type) must be created and System One's DOS menu command will be used in conjunction with operator input during a pause. As an example, use the Edit Comments capability to create the file shown in Figure 25-13.

The first line is the DOS Make Directory command (MKDIR); this example assumes a hard-disk-based system, and also assumes that a first-level sub-directory named TESTFILE has been created in the root directory of disk C; see your DOS manual for more details. The %1 following TESTFILE tells DOS to create a second-level subdirectory under the first-level subdirectory TESTFILE. The %1 symbol

is a substitution command to DOS, telling it to use the next item on the command line, following the batch file name, in place of the %1 symbol.

If this batch file is named NEWSERIL.BAT, for example, and you type from DOS

```
NEWSERIL ABCDE <Enter>
```

DOS will create a new subdirectory under TESTFILE called ABCDE. The full path name specification of this new subdirectory would be C:\TESTFILE\ABCDE. The second line of the batch file is the DOS Change Directory command (CHDIR). It tells DOS to change the current directory to \TESTFILE\ABCDE, since the %1 symbol will again be replaced by the characters which were typed in following the batch file name. Save this batch file by selecting or typing Save Comment and furnishing NEWSERIL.BAT <Enter> as the file name. To test its function, use the XDOS command to exit from System One temporarily. At the system prompt (assuming for the sake of example that you are in the root directory of a hard disk based system and that you have already created a first level subdirectory named TESTFILE by using the MKDIR command), type:

```
NEWSERIL 12345 <Enter>
```

On screen, you should see the following (if the DOS command PROMPT \$L\$P\$G has been executed so that the DOS prompt displays the current subdirectory along with the default disk drive designation):

```
C: MKDIR C:\TESTFILE\12345
```

```
C: CHDIR C:\TESTFILE\12345
```

```
C:\TESTFILE\12345>
```

The third line indicates that the new directory is now the current directory.

Type EXIT <Enter> to move back into System One software, and create a procedure which will use this batch file. Either Util Learn to record key-strokes, or Edit Procedure can be used to create a procedure as shown in Figure 25-14.

This example assumes that you have already created a test called TESTSTD.TST which is stored in the \TESTFILE subdirectory, that you wish to run that test on each unit of a series of production items to be tested, and that you wish a permanent record of that test (renamed to FINALTST.TST so as not to confuse it with the original setup) in a subdirectory whose name is the serial number of the unit. Any .LIM, .EQ, .SWP, etc. files used must also be stored in the \TESTFILE directory. Furthermore, this subdirectory must be specified along with the xx.LIM, xx.SWP, etc., file name when the Names menu command is used. You must thus type

```
Names Lower \TESTFILE\AMPLOW <Enter>
```

rather than the usual practice of selecting Names Lower, using the cursor to highlight the desired limit file name, and pressing <Enter>. The total length of the filename and directory names, including backslashes, cannot exceed 26 characters. If the backslash and directory name is not used, the system will look for the limit file in the newly-established subdirectory, not find it, and halt with an error message. This example is simplified; a realistic application might perform a number of tests and store a number of sets of results and/or error files in the subdirectory.

The procedure works like this: the operator will be prompted to enter the unit serial number; the first requested operation of the enter key is to erase the prompt and get ready to accept the serial number. The DOS NEWSERIL /F10 causes the system to pause, waiting for operator input, to complete the command line. If the operator types in B010237 <Enter>, the batch file NEWSERIL.BAT then runs with B010237 as the value to substitute for the %1 symbols. A new subdirectory named B010237 will be created in the TESTFILE first level subdirectory. That new subdirectory will be made the current directory. System One will load the test TESTSTD (plus any specified .LIM, .SWP, and .EQ files) from the TESTFILE directory. The test will be run and the setup and results saved. Since the Save Test command specifies no path name, the test will be saved in the current directory (\TESTFILE\B010237).

```
PROCEDUREv2.10
LOAD TEST SIGNOIRA/R
/F4/F1/F9/E
UTIL END
```

Figure 25-15 Signal to Noise Ratio Measurement Procedure

When the procedure is run again and a new serial number entered by the operator, the process will be repeated. The test TESTSTD and associated .SWP, .EQ, .LIM, etc. files will always be drawn from the TESTFILE directory, if the path name is explicitly designated.

The batch file NEWSERIL.BAT must be located in a directory which has its path designated in a path command typed in at system startup or (preferably) executed as part of an AUTOEXEC.BAT file, so that the system knows where to look for it even though the current directory is being changed every time the procedure is run. The PATH command is a DOS command to tell the system which other directories to search for an executable program if that program is not located in the current directory. If NEWSERIL.BAT is stored in a first level directory called UTILITY, for example, the path command typed or included in AUTOEXEC.BAT would be:

```
PATH C:\UTILITY;
```

25.14. System Startup With Procedure Running

A procedure name can be typed following S1 when starting System One from DOS; the result will be System One loading the procedure and executing it, with no operator actions required to start the procedure. This capability can be incorporated into an AUTOEXEC.BAT file and System One will run a procedure automatically when the computer is turned on. See the CREATING YOUR CUSTOM SOFTWARE START-UP PROCESS chapter for more details.

25.15. Continuously-Running Procedures

In a production test application, it is often desirable for a procedure to repeat continuously as the items to be tested flow across the test station. A continuously-recycling procedure is created either by inserting <R> <P> (Run Procedure) as the last step of a procedure, immediately before the Util End, or by using a UTIL GOTO command at that point with the line label of the first line of the procedure. A continuously-running procedure would normally start with either an operator prompt or a pause (/F10), requiring an <Enter> key operation from the operator to signify that the next device to be tested has been connected and is ready to go.

25.16. Signal-to-Noise Ratio Tests in Procedures

A signal-to-noise ratio test in panel mode is straightforward; supply the specified generator amplitude to the input of the device under test (or REGULATION mode to automatically adjust input amplitude until a specified value of output is obtained from the device under test), press <F4> to establish the analyzer dBr REF level at the present value, turn the generator off, and read the analyzer level (in dBr) for the signal to noise ratio. A variation on this technique can be created as a xx.TST file to insert in a procedure.

First, set up the System One generator panel to provide the desired signal frequency and amplitude to create the reference level for s/n testing. Select the AMPLITUDE mode of the main voltmeter, and select the desired analyzer band limiting filters and detector; 8 readings per second is appropriate for bandwidths down to 20 Hz. Set the SWEEP DEFINITIONS panel with GEN NONE selected at SOURCE-1. Select dBr for the display units. SAVE this TEST under an appropriate name (let's assume SIGNOIRA). Now, create a procedure as shown in Figure 25-15.

Note that this technique produces a negative number; an 80 dB s/n ratio will be displayed as -80 dBr. Thus, if you wish to establish -75 dB as the minimum s/n ratio acceptable, you must create the upper limit file as -75 dBr.

26. REGULATION

26.1. Introduction

Many audio measurements are made by frequency sweeps at a constant stimulus amplitude to the device under test. Sometimes, however, it is necessary to vary the amplitude of the stimulus at each different frequency in order to produce the desired output conditions from the device under test for measurement of some parameter. Examples include:

- measuring power bandwidth: the power output from a power amplifier at a specified distortion percentage across the audio spectrum
- measuring distortion of a power amplifier at its rated power output across the audio spectrum, even though the frequency response is not perfectly flat and the power output would thus not be held constant during a sweep at constant generator amplitude
- making broadcast proof-of-performance measurements, which require measuring the frequency response and distortion of a broadcast transmitter at a constant modulation percentage at all frequencies (even though the transmitter has imperfect frequency response and may also employ pre-emphasis)
- measuring the frequency response of a microphone at constant sound pressure level, even though practical loudspeakers and acoustical measurement chambers produce varying sound pressure levels at different frequencies
- measuring MOL (maximum output level): the output level at which an analog tape recorder and tape produce 3% distortion across the audio frequency range
- measuring SOL (saturated output level): the maximum output available from magnetic tape across the audio frequency range

Still other measurements involve varying the generator frequency as a function of measurements to determine a key point on the amplitude-frequency characteristic of a device under test. Examples include:

- determining the center frequency (maximum response point) of a bandpass filter such as one section of an equalizer
- determining the center frequency (maximum rejection point) of a notch or bandreject filter
- determining a specific point such as the lower -3 dB or upper -3 dB response point of an amplifier

Such measurements can be difficult and time-consuming with manual test equipment or automatic equipment not fitted with the special software features necessary to automate these tests.

System One's REGULATION mode permits these tests to be made automatically.

26.2. Regulation Concept

REGULATION is essentially a software servo-mechanism. Each time a regulation cycle is manually triggered by operation of the <Ctrl><F3> key or automatically triggered at each SOURCE-1 step during a sweep, the generator amplitude (or frequency, as selected) will be automatically adjusted by the software in an attempt to bring a specified measured output parameter of the device under test to a specified value.

26.3. Regulation Panel

The REGULATION panel of System One permits such measurements to be set up and run automatically, without tedious operator adjustments. The REGULATION panel is shown in Figure 26-1.

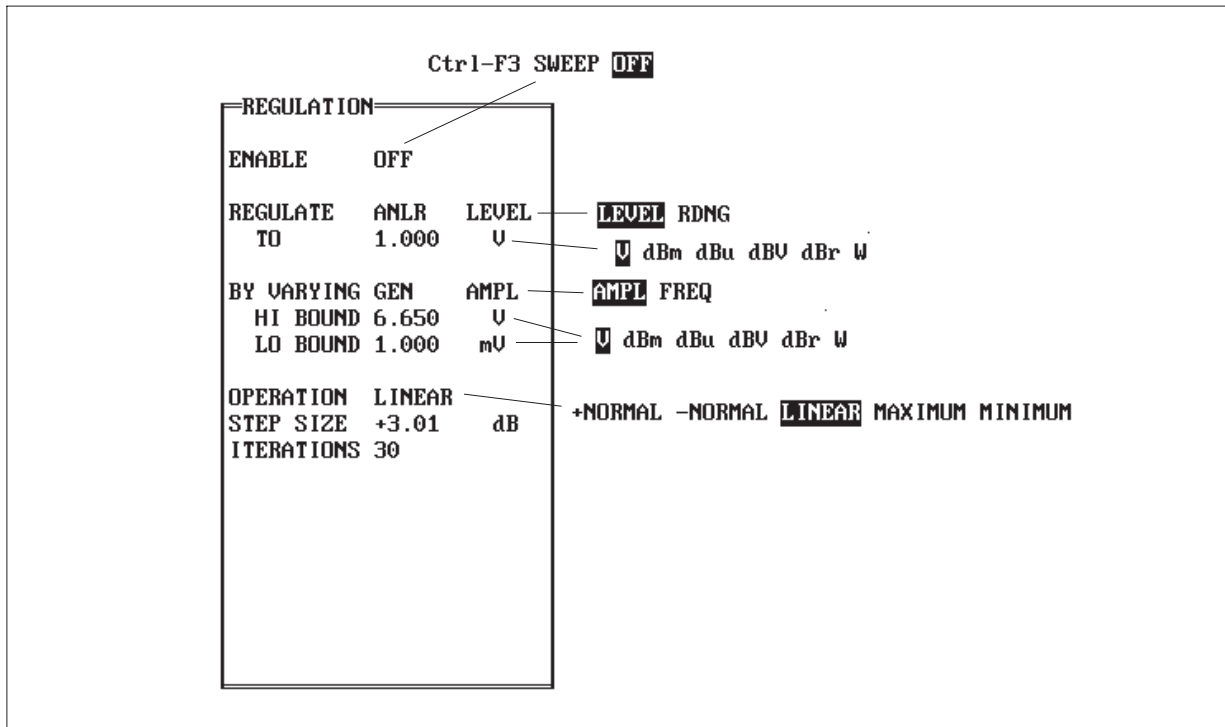

Figure 26-1 REGULATION Mode Panel

The ENABLE line permits selection of manual or automatic (sweep) means of triggering REGULATION mode, or turning the mode OFF. If <Ctrl-F3> or SWEEP modes are selected, regulation may be manually triggered by pressing <Ctrl><F3>. Regulation will be automatically triggered at every SOURCE-1 step in a sweep by selecting SWEEP.

The fields following REGULATE permit selection of the analyzer LEVEL voltmeter or the READING voltmeter (RDNG) as the analyzer-measured parameter to be regulated. The target numeric value at which the parameter is to be regulated (except for MAXIMUM and MINIMUM algorithms), in the units desired, is entered after TO on the next line.

The field following BY VARYING GEN permits selection of generator AMPL or FREQ as the parameter to be automatically varied.

The HI BOUND and LO BOUND fields permit setting boundaries outside which the generator amplitude or frequency will not be taken by the software while attempting to regulate the parameter. Setting these bounds is a safety factor for devices

such as high-power AM transmitters. Setting bounds may also be necessary to prohibit excursions into noise-limited or other undesired areas, or to prevent location of other maxima or minima when searching for a specifically-known maximum or minimum response point.

26.4. Regulation Algorithms

The selections on the OPERATION line determine the search algorithm which is used to arrive at the target value of the regulated parameter:

- **LINEAR** assumes a linear relationship between generator amplitude or frequency and the output parameter of the device to be regulated. This is normally a good assumption when regulating by varying generator amplitude in order to hold an output amplitude parameter constant while testing a linear device under test such as an amplifier (not a compressor or expander). Linear mode will not normally be used when varying generator frequency, since few devices (other than F-to-V

converters) have output amplitude characteristics which are linear functions of input frequency.

The LINEAR function regulation cycle starts at the GENERATOR panel AMPLITUDE, or the generator amplitude which produced regulation at the previous point in a sweep. It measures the amount by which the specified parameter deviates from the target value, and adjusts the generator amplitude by exactly that deviation. The LINEAR algorithm thus does not use the STEP SIZE parameter of the REGULATION panel. If the device is linear and the first measurement was not noise-limited, the LINEAR function will arrive at the target value in a single step. If the device is not exactly linear and the target value does not result from the first step, further iterations will be made with the amplitude being adjusted by the amount of deviation from the target on the previous measurement. LINEAR is the recommended mode to use in testing a broadcast transmitter at a constant, specified modulation value across the band. LINEAR is also recommended when testing power amplifiers at constant power across the spectrum. LINEAR would also be used to maintain constant sound pressure level in an artificial voice or acoustical test chamber, by using the output of a reference (flat response) microphone as the parameter to be regulated.

- **+NORMAL** does not assume linearity between generator amplitude or frequency and the measured parameter to be regulated. It does assume that increasing generator amplitude or frequency will increase the measured parameter and decreasing generator amplitude or frequency will decrease the parameter, but not necessarily linearly. This is typically the relationship at moderate-to-high signal levels between signal amplitude and distortion in an analog tape recorder, for example. It is also the typical relationship between generator frequency and output amplitude when testing a bandpass filter below its peak response point, or testing an amplifier in its low-frequency region to determine its lower -3 dB response point.

Like LINEAR mode, +NORMAL mode starts from the generator amplitude (or frequency) setting or the previous regulated point in a sweep. If the initial measured value of the parameter to be regulated is below the target, the generator amplitude (or frequency) will be increased by the STEP SIZE and the parameter measured again. If still below the target value, the generator amplitude or frequency will again be increased by the STEP SIZE. At the first step where the measured parameter exceeds the target value, the generator amplitude or frequency will be decreased by one-half the previous step size and the direction of change will be reversed. A binary search continues, with the step size cutting in half each step and the direction of generator amplitude or frequency change reversing each time the measured parameter crosses the target value until successful regulation is achieved. +NORMAL is the recommended algorithm for holding distortion at a constant value in tape recorders and in most electronics devices operating near their clipping level.

- **-NORMAL** is a similar algorithm to +NORMAL, except that it assumes that the measured parameter decreases as generator amplitude or frequency increases. This is a typical behavior for distortion measurements (especially wideband measurements such as THD+N) in electronic devices in the lower portions of their dynamic range, where they are commonly noise-limited. It is typical of the output-amplitude-vs-input-frequency characteristic of bandpass filters above their maximum response frequency, and of amplifiers at high frequencies, as when determining the upper -3 dB point.
- **MAXIMUM** and **MINIMUM** algorithms do not use the target number and units entered on the "TO" line below REGULATE, but instead control the generator amplitude or frequency so as to maximize or minimize the measured parameter specified on the REGULATE line.

Both MAXIMUM and MINIMUM modes start each cycle of regulation from the LO BOUND generator amplitude or frequency

value. In MAXIMUM mode, for example, the generator amplitude or frequency will be increased by the specified STEP SIZE as long as the measured value also increases. If the measured value goes through a peak and starts to fall off, the direction of generator amplitude or frequency change reverses and the step size is cut in half. These half-size steps continue until the measured value again goes through a peak and starts decreasing, at which time the direction of change again reverses and the step size is again cut in half. This process will continue until the number of peak crossings equals the value entered into the ITERATIONS field at the bottom of the panel. If the minimum generator amplitude or frequency resolution is reached before the peak crossings equals the ITERATIONS value, the search will also end. MINIMUM mode works similarly except that the algorithm expects decreasing measurements as the norm. It thus reverses direction and cuts step size in half when it passes a minimum in the measurement and the measured value starts to increase.

MAXIMUM is the algorithm to use in determining saturated output level (SOL) from magnetic tape. It is also the mode, while varying generator frequency, to locate the resonant frequency of a bandpass filter. MINIMUM can be used to determine the minimum THD+N point of an amplifier, where it becomes noise-limited at lower amplitudes and distortion-limited at higher amplitudes. In many amplifiers, this point lies just below the threshold of clipping. MINIMUM, when varying generator frequency, will locate the frequency of maximum rejection of a notch (band-reject) filter.

In both MAXIMUM and MINIMUM modes, a value of 5 is a good starting point for ITERATIONS. Values as low as 3 may work satisfactorily. Depending on how well known the location of the maximum or minimum is when the test is set up, test speed may be optimized by using a large value for STEP SIZE and increasing ITERATIONS to a value as high as 7 to assure that the peak or dip is accurately located.

STEP SIZE defines the size of amplitude or frequency steps the generator will take in +NORMAL, -NORMAL, MAXIMUM, or MINIMUM modes as it begins its search at the beginning of each new regulation cycle.

ITERATIONS limits the maximum number of REGULATION attempt steps the generator will make at any SOURCE-1 value before exiting the search and moving on to the next SOURCE-1 step. With LINEAR mode, only a single step or a few iterations are normally needed. In MAXIMUM and MINIMUM modes, values from 3 to 7 are typically appropriate. In other modes, particularly when the starting value is far removed from the final target, many iterations may be required and the panel setting should be increased from its normal default.

26.5. Success In Regulation

The search algorithms will exit their search, plot the data, and move on to the next SOURCE-1 step (assuming SWEEP mode) when the specified parameter has been brought to the numerical target, plus or minus the TOLERANCE value for that parameter on the SWEEP SETTling panel. If, for example, THD+N is the parameter being regulated, 2% has been set as the target value, and the THD+N TOLERANCE on the SETTling panel is 5%, the algorithm defines success as arriving at a measured value between 1.9% and 2.1% THD+N.

Success may not be achieved for a number of reasons. If success cannot be reached, the computer will signify its problem with a double “beep”, will plot the data but write a “U” (for Unregulated) in the lower horizontal margin of the graph or display “UNREGULATED” next to the data in a table, and move to the next frequency (if in SWEEP mode). “UNREGULATED” will also be written into an error file if one has been named. Reasons for failure to regulate include:

- Not reaching regulation within the number of attempts (steps) specified in the ITERATIONS field
- Hitting the HI BOUND or LO BOUND value twice during a search

- Bracketing the specified target value of the parameter to be regulated when changing the generator amplitude or frequency by the minimum generator resolution available.

When using REGULATION mode with noisy signals, regulation may sometimes be achieved but a value then displayed which is outside the regulation tolerance. This is due to the fact that the displayed value (if the regulated parameter is also being displayed) is the following reading obtained from the hardware after regulation is achieved. When making MOL measurements on cassette tape recorders, for example, the sample-to-sample variation may cause the next reading after regulation to be outside the tolerance bounds on the regulated parameter. If the UNREGULATED flag did not appear, it can be assumed that regulation was successfully achieved.

26.6. Setting Up A Regulation Test

It is frequently most productive to use the manual (<Ctrl><F3>) trigger mode during REGULATION test setup. It is also helpful to have the GENERATOR panel, ANALYZER panel, and the REGULATION panel simultaneously visible during setup. This panel arrangement is accomplished by starting from the usual GENERATOR-ANALYZER-SWEEP (F9) DEFINITIONS panel layout, putting the cursor on the SWEEP (F9) DEFINITIONS panel, and operating <Ctrl><PgDn> until the REGULATION panel appears in the right-hand section of the screen.

First select the analyzer measurement function (THD+N, AMPLITUDE, etc.). After making the initial settings for the parameter to be regulated and its value, generator AMPL or FREQ to be varied, the HI and LO BOUNDS, algorithm type selection (+NORMAL vs LINEAR, etc.), STEP SIZE, and ITERATIONS, select <Ctrl><F3> mode on the ENABLE line and press the <Ctrl> and the <F3> function keys simultaneously. Assuming generator amplitude is being varied, dual cursors will appear on the GENERATOR AMPLITUDE field and the selected analyzer parameter display field, and you can watch the algorithm search for the target value. You may wish to enter a value of several hundred

milliseconds in the SETTling DELAY field of the SWEEP SETTling panel in order to slow down the operation for easy visual monitoring. Watching the operation gives a good feel for REGULATION mode and can quickly show incorrectly-set parameters such as improper generator amplitude bounds. When you are satisfied with regulation in <Ctrl><F3> mode at two or three key frequencies, you may wish to go to SWEEP mode and try a full-range frequency sweep. (Don't forget to reset the settling delay to a short value for fastest testing).

The diskette of sample tests and procedures includes tests using REGULATION mode. These may be examined and used to gain experience with REGULATION function. The REGULATION mode tests include:

- FREQ-CON.TST for frequency response of broadcast transmitters at constant modulation percentage
- GAIN.TST for measuring gain or loss of devices at a 0 dBu output level
- DIST-PWR.TST for measuring distortion versus frequency at a constant output power from an amplifier
- PWR-BAND.TST for measuring the power bandwidth of an amplifier (power versus frequency at a constant distortion percentage)

26.7. Data Display

The parameters to be displayed during a sweep test are selected at DATA-1 and DATA-2 of the SWEEP (F9) DEFINITIONS panel as in any other test. Note that the parameter being regulated does not necessarily need to be graphed. For a tape recorder example, it may be desired to plot tape recorder output amplitude as DATA-1 and generator amplitude as DATA-2 while using regulation mode to assure that these measurements are made at the 3% THD+N point across the audio range.

Generator amplitude is a selectable display parameter as the DATA-1 or DATA-2 value. The generator amplitude may be displayed as AMPL or IN-VAMP. AMPL produces a conventional plot of gen-

erator amplitude, while INVAMP plots the generator amplitude in dB_r units. The INVAMP mode is useful in applications such as measuring broadcast transmitter frequency response at constant modulation percentage. In this and similar cases when the device-under-test output is deliberately held constant, the response of the device-under-test is the inverse of the generator amplitude required to produce constant output amplitude across the frequency range. INVAMP thus produces a conventional frequency response plot.

27. TESTING SPEED

Testing speed is affected by many factors, most of which are under the control or influence of the person setting up the tests and the system.

27.1. Time Per Step

Time per measurement point (step) varies with a number of parameters.

- DISPLAY NONE is faster than graphic or table display. DISPLAY MONO-GRAPH or DISPLAY COLOR-GRAPH is usually faster than DISPLAY TABLE unless the test consists of a very small number of points, in which case the time required to draw the grid may cause graphic display to be slower than tabular.
- FAST mode of generator frequency control is faster than HIGH-ACCURACY mode.
- THD+N and SMPTE measurements take longer to settle than amplitude, frequency, or phase measurements.
- All measurements take longer at low frequencies.
- Specifying fewer SAMPLES and looser TOLERANCE values on the SWEEP SETTling panel will speed tests. The EXPONENTIAL settling algorithm “window” shape will normally produce faster tests than the FLAT choice. Increasing the value of RESOLUTION may speed tests when very small values are being measured.
- Using both DATA-1 and DATA-2 to take two sets of data in a sweep may add only a small increase in time compared to a single-parameter-sweep of the slower of the two measurements. The result is faster than running two separate tests, each with one DATA parameter. For example, since THD+N is usually the slowest measurement, a second DATA line for LEVEL can usually be added to a THD+N test with negligible speed penalty.
- With instruments with serial number SYS1-20300 or higher, stereo amplitude measurements can be made much faster in 2-CHANNEL mode (READING and LEVEL assigned to DATA-1 and DATA-2) than by using the STEREO mode, which uses only one voltmeter and makes two successive sweeps.
- FIXED range is faster than AUTO range. In AUTO range mode, when the measured signal amplitude moves outside its present 6 dB “window”, the analyzer input gain or attenuation is changed. When the signal is removed, the instrument autoranges to its most sensitive range. When the signal is restored, the instrument autoranges back to the most sensitive range which will not clip signal peaks at the present level. Depending upon reading rate, this up-ranging and down-ranging can take many hundreds of milliseconds or even seconds at low frequencies. If the maximum possible signal amplitude is known in advance, tests can be saved with the fixed range selected which will safely handle that maximum amplitude and significantly faster operation will result. However, if the signal amplitude should increase above the fixed range maximum, clipping can occur with serious measurement errors resulting. See the ANALYZER chapter for more detailed information of range fixing.
- The AVG detector is slightly faster than the RMS detector, while the Peak, Q-Pk, and S-Pk detectors are much slower. However, the AVG detector should be used only when the signal is known to be a sinewave or a band-pass-filtered signal which has similar characteristics to a sinewave.

27.2. Sweep Time

Test time is only approximately proportional to the number of points in a sweep. For simple sweep-and-graph or sweep-and-display-table operation, the time will not increase linearly with the number of points due to the action of the SWEEP SETTling algorithm. As any given frequency span or amplitude span is stepped across in smaller steps, the transient change in the measured values will normally be less and settling occurs more rapidly. However, adding points will always add to the test time. In a time-critical application where data is required at only a few points, specify only what is needed. If the required points are not either linearly or logarithmically distributed between the end points, use the sweep table capability.

27.3. Limits and Speed

Attaching upper or lower limits to a test significantly increases test time due to the necessity of loading limits files into memory and to the computations at each point to determine whether the measurement is inside or outside limits. Limits files which are simple rectangular limits specified by only one or a few points will run faster than limits files with many points. Faster operation will be obtained when the limits file and the test file go through the steps in the same direction (both high-to-low, or both low-to-high). Attaching an error file to a test with limits will slow the test still further due to the time necessary to write out-of-spec values into the error file.

Limit (and equalization and sweep) files up to 200 points are loaded into memory when a sweep is started (<F9> or <F7>) with their associated test loaded. This assumes that S1 software was not loaded with the /B option. Test speed with limits up to 200 points is thus independent of the type of disk used in the computer, after the limit (and equalization and sweep) files are loaded. If limits files larger than 200 points are used, the portions beyond 200 points will be accessed on disk and test speeds will slow down markedly, especially with floppy disks. If larger limit (or EQ or sweep) files are required, S1 software can be loaded with the /B op-

tion so that the larger files can still load into memory. See the "Controlling Memory Usage" section of the CREATING YOUR CUSTOM SOFTWARE START-UP PROCESS chapter for more details.

27.4. Equalization and Speed

Use of the EQSINE feature and a xx.EQ file also slows testing since the computer must usually interpolate between xx.EQ file values to obtain the value to use at the generator frequency value. As in the case of xx.LIM files above, the best speed is obtained with the smallest xx.EQ files and with xx.EQ files arranged in the same frequency order as the xx.TST sweep is proceeding. With standard memory allocations, the first 200 points of the xx.EQ file are loaded into memory when a sweep is started. Operation will slow due to disk accesses if larger equalization files are used. If larger files are required, S1 software can be loaded with the /B option in such a way that they will automatically load into memory. See the "Controlling Memory Usage" chapter of the CREATING YOUR CUSTOM SOFTWARE START-UP PROCESS chapter for more details.

CONFIG.SYS file:

```
DEVICE=VDISK.SYS BUFFERSIZE
100K
```

AUTOEXEC.BAT file:

```
ASTCLOCK
MOUSE
C:
COPY A:*.TST
COPY A:*.PRO
COPY A:*.LIM
COPY A:*.EQ
COPY A:*.IMG
COPY A:*.DAT
COPY A:*.TXT
COPY A:*.SWP
COPY A:*.OVL
B:S1
```

Figure 27-1 CONFIG.SYS and AUTOEXEC.BAT Files for Virtual Disk

27.5. Graphics Save Mode and Speed

If S1.EXE software is started with /G option to enable saving high-resolution .GDL files to disk, testing speed will be significantly slowed. In the /G mode, every graph vector drawn to the screen is also written into a .GDL disk file with a consequent slowing of operation.

27.6. Disk Types and Testing Speed

Files used during a testing operation may be stored in three ways; on diskettes (floppy disks), on a hard (fixed) disk, or on virtual disk (ram disk). Diskettes have the slowest access times and data transfer times. Hard disks are much faster in both access and data transfer times and yield faster-running tests. Hard disks also hold large amounts of data, typically 20 megabytes and up. They are therefore much more convenient for operation, eliminating the frequent changing of diskettes often required in diskette-based systems. Hard disks also permit convenient accumulation of test data over a period of time. The data may then be accessed by spreadsheet or statistical programs to perform statistical analysis on the data.

27.6.1. Virtual Disks

Virtual disks are portions of the computer memory (ram) set aside during operating system start-up and made to look like another disk drive. If your computer has no hard disk, but has substantially more memory than that required for System One operation plus reasonable DOS activities under the DOS or XDOS commands, virtual disks may be a good solution to testing speed. If you have a hard disk, there is little speed to be gained by use of virtual disks. With recent DOS versions, your DOS manual will describe how to use the VDISK.SYS and CONFIG.SYS capability to create virtual disks at system start-up. For regular daily testing typical of ongoing production test activities, you may also wish to add commands into your AUTOEXEC.BAT file which copy from diskette onto the virtual disk the test files and limits files which are regularly

used. A typical CONFIG.SYS and AUTOEXEC.BAT file for this type operation are shown in Figure 27-1.

This example assumes that the files VDISK.SYS (a DOS file), CONFIG.SYS, ASTCLOCK (if you have one of the AST (TM) clock-calendar units in your computer), MOUSE.COM, and the test, procedure, limit, equalization, etc. files are all on a bootable diskette in the A: drive. It assumes that S1 is on a diskette in your B: drive. The CONFIG.SYS file causes VDISK.SYS to run at start-up, setting aside 100k bytes of memory (amount controlled by the BUFFERSIZE parameter) which is automatically designated as the C:\ drive on a computer with no hard disk. The AUTOEXEC.BAT file then sets system date and time from the clock-calendar card (ASTCLOCK), runs the MOUSE driver software, changes the current disk drive to C: (the new virtual disk), copies onto it the desired files from disk A:, and finally loads System One software from drive B. However, it leaves C: as the current drive so that the system will look for all files and store all files there.

Since a virtual disk is computer memory which will be lost at power-down or system re-start, operational procedures must be established to copy from virtual disk to diskette any files desired to be kept after system shut-down. A procedure may include disk drive designators in any Save commands, or explicitly in the file name of an error file. For example, when operating from a virtual disk designated C:, which contains all the procedures, tests, limits, equalization files, sweep tables, etc., the error file name attached to each test may be specified as B:errorfile. This will not provide the absolute fastest operation since the flexible disk in drive B will be accessed frequently for test summary information. It will eliminate the risk of error file data loss and the necessity of copying the error file from the virtual disk to the diskette before turning off computer power or re-booting the system.

27.7. Computer Types and Speed

Five families of microprocessors are in wide use as the central processors of the various computer models compatible with System One. The original IBM PC, PC Portable, XT, the Compaq Portable, and many other machines use the 8088 processor. The original Compaq Deskpro, AT&T 6300, Olivetti M21 and M24, IBM System 30, and certain other computers used the somewhat faster 8086. The IBM PC-AT, Compaq Portable II, IBM System 50 and 60, AT&T 6300 Plus, and Compaq Deskpro 286 use the 80286, which is faster yet. Still more powerful computers in this category, such as the Compaq Deskpro 386 and IBM System 80, use the 80386. The fastest PC-compatible computers now available use the 80486 processor. Various computers using the same microprocessor may run it at different clock rates. The clock rate will directly affect its computational speed.

Although the microprocessor is capable of performing mathematical operations, it does not do so efficiently. Integrated circuits which perform math operations in hardware are available for all of the IBM and compatible computers. ***A math co-processor should be installed in any computer used with System One for the maximum speeds. It will make the largest difference on the slowest computers (8088-based).***

The actual measurement times of System One within any test (xx.TST file) are determined largely within the instrument hardware. Actual test times will thus not vary as much with the type of computer used as will purely computational activities and disk access actions. However, speed improvements of as much as 30% have been noted with AT-compatibles (80286-based) over PC-compatibles (8088-based). In a sweep test with a log horizontal axis and one or two dB units on the vertical axis, the faster computers will produce reductions in sweep times. This is because they are much faster in the computationally-intensive activities such as log conversions. Faster computers also speed the comparisons involved in testing with limits and equalization files.

In a procedure, many different tests must be loaded into the System One software in sequence, and many computations are required to translate the stored information into panel settings and instructions to the hardware. Assuming that a hard disk or virtual disk is used so that diskette access time and data transfer rate are not the limiting factors, the faster computers will make quite significant reductions in this test loading activity. Benchmark tests have been run which show the 80286-based computers to cut test loading times from the 3-4 seconds typical of 8088 machines down to approximately 1 second. Depending on the number of different tests in a procedure and the length of each test, the 80286-based machines have been seen to cut procedure times typical of real world applications almost in half.

27.8. FASTEST.DSP and Speed

A new program for the DSP-based versions of System One can produce on the order of ten-times-faster testing for most common audio measurements. This program and technique, called FASTEST, stimulates the device under test with many sine-waves simultaneously, acquires the output signal and performs an FFT analysis, and then can measure frequency response, noise, total distortion and noise, interchannel-phase (if stereo), and can also measure harmonic or intermodulation distortion separately from the total distortion measurement. On the order of one to two seconds of stimulus are required, with all the measurements listed above then made within two-four additional seconds. Contact Audio Precision for more information on DSP units and the FASTEST technique.

27.9. Software and Speed

Most of the discussion above assumes that S1.EXE, System One's panel-and-menu oriented software, is being used. This software permits faster and easier preparation of tests and procedures than any other approach to automated testing. For the absolute fastest testing speed, experienced programmers can develop programs in the Microsoft BASIC Professional Development System v7.10 (which in-

cludes the Microsoft QuickBASIC Extended Environment) or in Microsoft C language v5.1 or later, using Audio Precision's LIB-BASIC or LIB-C function libraries to control System One hardware. In some cases, such programs cut testing time in half compared to S1.EXE tests and procedures.



28. CREATING YOUR CUSTOM SOFTWARE START-UP PROCESS

Getting from power turn-on to a status ready to run tests and procedures can involve several steps:

- booting DOS
- setting the computer time and date (if not automatically maintained in your computer)
- running the MOUSE program (if you have a mouse)
- changing the default drive or directory to the drive or directory where the test, limit, procedure, etc. files are located
- loading S1 with the desired memory set-asides for DOS operations, proper display system selected, desired graphic print-out size selected, etc.
- going to PANEL mode after System One software loads and selecting the generator output configuration, levels, analyzer filter selection and units, sweep conditions, etc.

It is possible to automate this entire sequence. You can then begin each day's work from your own preferred starting conditions merely by turning power on to your computer and System One.

28.1. Making A Bootable Diskette

First, format a blank diskette with your DOS on it according to the instructions in your computer's manual. With a two-drive computer, the DOS disk in drive A, and the blank diskette in drive B, this normally is done by typing

```
FORMAT B:/S <Enter>
```

If you will be using the mouse option, replace the A: diskette with the mouse software diskette and type

```
COPY MOUSE.COM B: <Enter>.
```

Note that newer versions of mouse software from Microsoft come with an installation routine.

Proceed by then copying all the xx.TST, xx.PRO, xx.EQ, etc., files which you will regularly use onto the new diskette by placing the disk or disks containing those files in the A drive and typing

```
COPY *.TST B: <Enter>
COPY *.PRO B: <Enter>
COPY *.EQ B: <Enter>
COPY *.SWP B: <Enter>
COPY *.TXT B: <Enter>
COPY *.DAT B: <Enter>
COPY *.LIM B: <Enter>
COPY *.OVL B: <Enter>
COPY *.DSP B: <Enter>
COPY *.WAV B: <Enter>
COPY *.MAC B: <Enter>
```

28.2. Creating an AUTOEXEC.BAT File

AUTOEXEC.BAT is a special file name to DOS; whenever DOS is started, it looks on the default drive to see if a file of that name is present. If it is, DOS will automatically execute the instructions in that file.

Create an automatic startup batch file on the new diskette so that it will run the various utilities, establish the desired drive (where the test, procedure, etc. files are located) as the default drive, and load System One software after DOS loads. This can be done directly from DOS using the COPY CON (copy from console) command. Instead, it is much

more convenient to create the batch file from a text editor which gives you the ability to view the file and make insertions or deletions before saving it.

The following example assumes you are using the Edit Comments capability of System One as the text editor. To use the S1 editor, place the S1 diskette or a copy of it in drive A and type S1 <Enter>. After the software loads and the Audio Precision logo appears, type <E> <C> to go to the Edit Comments feature and type the following:

```
MOUSE <Enter>
```

(assuming that you wish to use a Microsoft Mouse with your system)

Now enter any other commands or programs to be run before System One starts. A common example for XT type machines is a program to set the computer time and date. If you have a clock/calendar card such as the AST 6-Pack (TM) installed, the command would be

```
ASTCLOCK <Enter>.
```

If you have no clock/calendar card, type in the commands

```
TIME <Enter>
```

```
DATE <Enter>
```

so that the system will prompt the operator to enter the correct time and date upon start-up.

```
B:S1 <Enter>
```

or:

```
B:S1 filename <Enter>
```

or

```
B:S1 filename filename <Enter>
```

or

```
B:S1 /r100 <Enter>
```

or

```
B:S1 /R64 /D2 /P3 filename <Enter>
```

or

```
B:S1 /D1
```

These various alternative commands tell DOS to load and run S1.EXE from the B: drive, without changing the default drive from A:. It is not necessary to type the xx.EXE extension. This must be the last line of the AUTOEXEC.BAT file. The options of including a xx.TST filename or or xx.PRO filename or both on the command line will cause S1 to load a specific test and/or or start up with a specific procedure; see COMMAND LINE OPTIONS below for more details. The /D option specifies the type of display system in the computer. The /R option specifies the amount of memory set aside for DOS and XDOS operations. The /P option specifies the printer mode.

The final version in the Edit Comments buffer may look like this:

```
MOUSE
ASTCLOCK
B:S1
```

or possibly

```
MOUSE
DATE
TIME
B:S1 /P3 /D1 /R120 /F PERFCHEK
```

Save this text to the new diskette in the B drive with the menu commands <Esc> Save Comments and the filename B:AUTOEXEC.BAT. The extension xx.BAT must be explicitly supplied; if not, the system supplies the extension xx.TXT since it assumes you are saving a System One comments file. The xx.BAT extension is mandatory for DOS to recognize it as a batch file.

28.3. Testing The Startup Process

To verify function, move your new diskette to the A drive. Place a copy of the appropriate S1 version in the B drive. Restart the computer by pressing

<Ctrl>, <Alt>, and all simultaneously. This is called a “warm boot” by computer people, as distinguished from a “cold boot” which is done at power up. The “cold boot” goes through a complete computer memory check which can take up to a minute with a memory-loaded machine, while the “warm boot” goes directly to the software start routine. If all was done correctly, the computer will go automatically through the process you defined, culminating in the Audio Precision logo (or into an operating procedure, if a procedure name was supplied following S1) without further assistance.

28.4. STD.TST File to Set Initial Conditions

To further customize System One software so that it starts with your choice of panel conditions, go to Panel mode and set every parameter as you wish it to be at startup. You are likely to have preferred choices for units, generator source impedance and balanced/unbalanced condition, output level, analyzer input termination, principal voltmeter function, bandwidth, detector type, dBr REF and dBm/W REF values, sweep start and stop values and number of steps, color versus monochrome graphs, etc. You may also wish to use the Names Title function to replace AUDIO PRECISION in the upper left corner of monochrome graphs with a title of your choice. You will possibly wish to change some of the parameters on the SWEEP SETTling panel.

When you have the entire set of panels as you wish them to be at startup, <Esc> Save Test and type in STD <Enter> for the test name. System One software, whenever it loads, looks in the default disk directory for a file with the name STD.TST and loads it if it exists. You may now test the function of your complete automated start by doing another warm boot (<Ctrl> <Alt>). System One should load automatically, and examination of the panels should show them all exactly as you set up the STD.TST file.

28.5. Command Line Options

A number of different modes of operation of System One software can be obtained. Some of these modes are selected by typing the slash symbol “/” and characters after the “S1” when loading S1. An on-screen listing of the available options can be obtained by typing either S1 /? or S1 /HELP at the DOS prompt. These command line options permit System One to:

- start with a specific test already loaded (S1 testname)
- start with a specific procedure loaded and running (S1 procedurename)
- start in the correct graphics mode for the computer graphics board and monitor in use (S1 /D#)
- find the Audio Precision interface board at a specific address in the computer, or notify the software that no interface card is installed (S1 /I#)
- start with the last test and procedure loaded but not running (S1 /L)
- control the amounts of memory set aside for data and various buffers (S1 /B#,#,#,#,# and S1 /R#)
- disable Image Store and sweep-erase-repeat capability (<Alt><F8>, <F8>, <Alt><F9>) in return for 16k to 38k additional available memory (S1 /8)
- select the mode in which the buffer contents are swapped to disk during XDOS and DOS actions (S1 /&filename)
- specify the printer type which is connected, and the exact height and width of the printouts which result from pressing the <*> key (S1 /P#,#,#)
- disable the two-per-page formatting and automatic page feeds of <*> graphic printouts (S1 /F)
- enable graphics reporting to a .GDL file for later transmission to a plotter or laser printer (S1 /G)

- set some video attribute other than standard defaults with which to display “punched-out” fields in overlay (xx.OVL) files (S1 /V#)
- use the “European” impedance values for generator output and analyzer terminated inputs, if the “EURO” option is installed in the System One hardware being used (S1 /E)

More than one of these options may be invoked on the same command line. A space must be used between the last character of each option and the slash of the following option. For example:

```
S1 /L /R96 /V82
```

28.5.1. Starting With a Specific Test or Procedure

A method for starting S1 with a desired test file already loaded, or running a desired procedure, is to include those file names on the command line, after S1. The STD.TST approach is preferable if you always wish the system to start up in a specific condition. If you wish it to start in different conditions at different times, however, it may be preferable to use the command line approach. To cause S1 to load a file called ABC.TST as soon as S1 itself loads, type S1 ABC <Enter> instead of S1 <Enter>; the effect is identical to typing S1, waiting for it to load, then typing Load Test ABC <Enter>. To cause S1 to begin executing a procedure called XYZ.PRO as soon as S1 loads, type S1 XYZ <Enter>; the effect is identical to typing S1 <Enter>, waiting for it to load, then typing Load Procedure XYZ <Enter> Run Procedure. This can be a very desirable loading option, as part of the AUTOEXEC.BAT file, in production test operations with low-skilled operators. Simply turning on the computer, with the proper disk in the drive, will launch them directly into an operating procedure.

Both a xx.TST file and a xx.PRO file can be included on the command line, in either order. Using the file name examples above, type either S1 ABC XYZ <Enter> or S1 XYZ ABC <Enter>. Since

most procedures start out by loading a test file, however, this two-file command line may not be required in most cases.

When one or more of the “/” command-line options and a procedure or test file name are to be included, the “/” options should all precede the test or procedure file name. For example:

```
S1 /R96 /V0 /F AMP-FREQ
```

28.5.2. Starting Up With the Last Test

As noted in the MENU chapter, when you QUIT System One it automatically saves to the default disk the test, procedure, and macro currently in use as APLAST\$\$TST, APLAST\$\$PRO, and APLAST\$\$MAC. If you would like to begin the next time where you last left off, start System One (assuming you are starting with the same disk directory which was the current directory when you quit) with the command line option

```
S1 /L
```

System One will then start with the test, procedure, and macro stored as APLAST\$\$ in place, though it does not automatically start executing the procedure as it would if a procedure name were explicitly typed in on the command line.

28.5.3. Graphics System Compatibility

S1.EXE supports many different graphics display systems typically found in IBM-compatible computers, including CGA, EGA, VGA, Hercules high-resolution monochrome, and the plasma display of the Toshiba 3100. In most cases, the software can determine which graphics system is present and configures itself accordingly. In some cases this automatic configuration may not be satisfactory. In these cases, a specific graphics system mode can be forced by use of the /D# command line option. See the table on page 5- 7 for full details.

28.5.4. Interface Card Locations

The original PCI-1 computer interface card is always located at address 238, and all software versions before 1.60 worked only with that address. The PCI-2 card address can be set via jumpers to addresses 238, 298, 2B8, or 2D8. “S” (serial) version System One can be operated from lap-top computers with no interface card installed. To eliminate an error message each time the software is loaded, it can be started with the /I0 option.

S1.EXE software normally conducts a search, in order, through the addresses listed above to locate the interface card. It is possible to start the software so that it looks at only one address, or so that it does not look for an interface card at all. The command line options are:

/I0	no interface card
/I1	PCI-1 at 238
/I2	PCI-2 at 238
/I3	PCI-2 at 298
/I4	PCI-2 at 2B8
/I5	PCI-2 at 2D8

28.5.5. Controlling Memory Usage

When you first turn on computer power or reboot with the <Ctrl><Alt> keys, the software operating system (DOS) is loaded into the lowest memory addresses. Many versions of DOS in use today occupy 40k-60k bytes of memory.

A special file called CONFIG.SYS will then run, if it exists. Some of the actions taken by CONFIG.SYS will cause memory to be used. For example, CONFIG.SYS can specify a number of buffers to be used to speed many computer operations. Each buffer occupies 528 bytes. Thus, a BUFFERS=20 command would use 10k of memory. If CONFIG.SYS creates a “ram disk” (virtual disk) in the 640k bytes of DOS-addressable memory, that space is unavailable for other applications.

AUTOEXEC.BAT then runs, if it exists. AUTOEXEC.BAT may load one or more programs called “TSR”s. TSR stands for “Terminate but Stay Resident”. This class of programs includes things such

as mouse drivers and DOSEDIT, a public-domain program distributed by Audio Precision. Mouse drivers may occupy from 3k to 15k bytes; DOSEDIT occupies about 3k of memory. TSR programs also include the many “DOS management” programs which permit users to change directories, make directories, erase files, etc., without learning DOS commands. Many of these programs occupy large amounts of memory such as 50k to 80k or more.

28.5.5.1. System One Memory Requirements

So, by the time you are ready to type “S1”, 60,000 to 150,000 or more of the 655,000 bytes of memory may already be occupied by various programs. At the beginning of its loading, S1.EXE checks the amount of memory remaining. If there is not approximately 475 kbytes or more (assuming v2.10), S1 will not load and this message will result:

Cannot reserve the requested amount of memory. S1 /? will give information on /R and /B options. See Command Line Options section of manual or use “/?” for option info.

If 475 kbytes or more are available, S1 normally decides how to occupy that memory according to a set of built-in rules. A decision and rules are necessary since the total memory occupied is made up of an irreducible 367k bytes (version 2.10) which the “core” S1.EXE program must occupy in any case, plus eight other functional areas of memory occupancy which are potentially controllable. See Figure 28-1 for a representation of typical memory occupancy by DOS, a few small TSR programs, and S1.EXE as determined by the built-in rules. The user has the ability to over-ride the standard internal rules with her or his own better judgement on how that memory should be used. The /R, /8, /B, and /&filename command line options are the methods the user has to control memory occupancy in detail.

28.5.5.2. Memory Reserved for Programs to Run Under XDOS or DOS Exit

S1.EXE was designed with the ability to remain in memory during a temporary exit to the operating system to run other programs. The XDOS and DOS menu commands leave S1.EXE in memory to avoid the time that would be taken by a QUIT and re-start. The most common reason to temporarily exit is probably to change to another directory on a hard disk where other tests are stored. Some complex testing applications also call for special programs to process test data into a more suitable form for viewing; the CDLINEAR.EXE and COMBINE.EXE programs furnished on the Compact Disc Player Testing application note diskette are examples. The built-in rule for S1.EXE is to set aside 64k (65,536 bytes) of memory for such programs to run. The user can use the /R option to specify larger or smaller amounts to be set aside. For example, starting the software

S1 /R28 <Enter>

will cause only 28k instead of 64k to be reserved for programs running during an XDOS or DOS exit.

28.5.5.3. Screen Display Memory

The <Alt><F8> feature of System One software permits a monochrome version of any graph to be captured as a "snapshot" into memory. A later <F8> operation instantly returns that graph to the screen. The <Alt><F9> command creates a continuous sweep-erase-repeat cycle of taking and displaying test data. Both these features use memory to store the screen image. The memory occupied is approximately 38k for VGA, 33k for Hercules, 28k for EGA, and 16k for CGA display systems. If neither the <Alt><F8>/<F8> feature nor the <Alt><F9> feature is necessary for your testing, you can start the software

S1 /8 <Enter>

which frees screen memory for other uses.

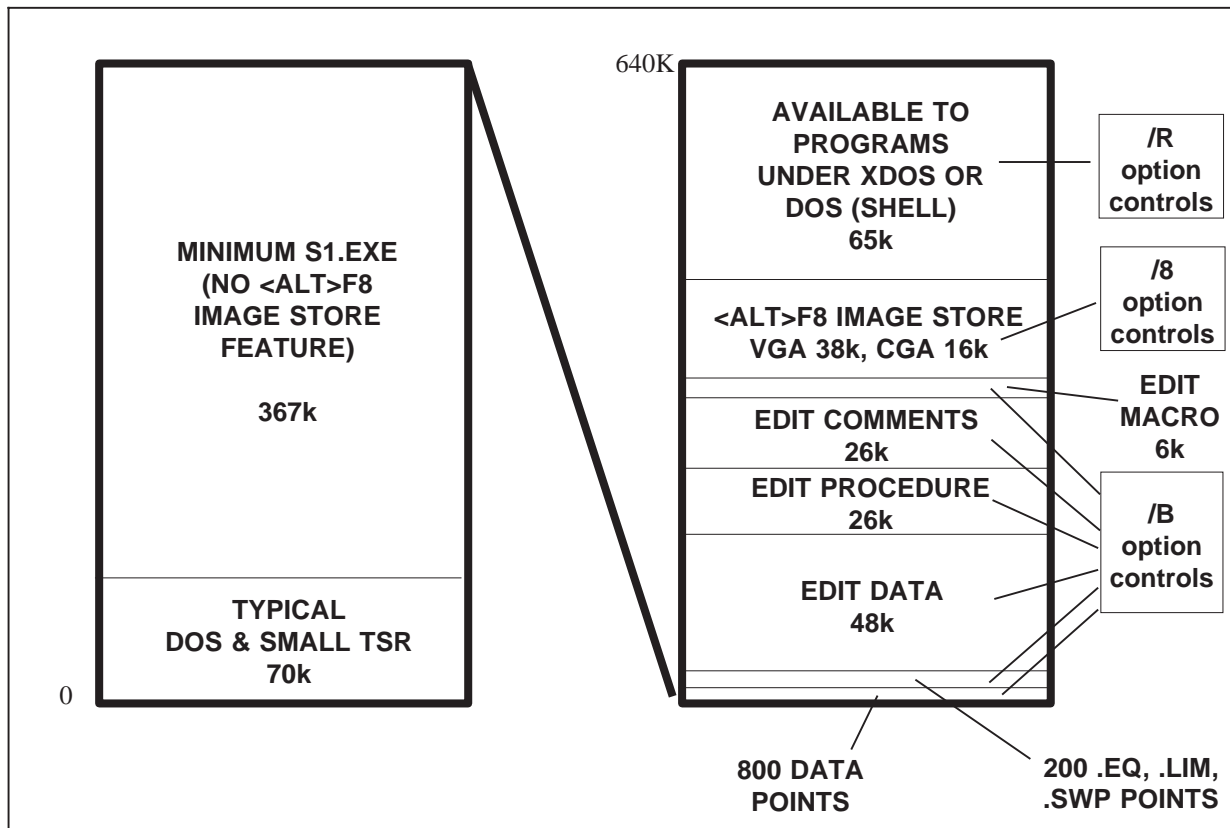

Figure 28-1 Typical Memory Occupancy, 640 k Computer with Small TSRs and Normal S1.EXE Load

28.5.5.4. Internal Buffers of S1.EXE

S1.EXE sets aside six memory areas for use during testing. These six buffers are:

- Data Point buffer
- Limit/sweep/EQ file buffer
- Edit Data buffer
- Edit Procedure buffer
- Edit Comment buffer
- Edit Macro buffer

The amount of memory presently set aside for each of these buffers may be read at any time by displaying the HELP screen.

28.5.5.5. Data Point Buffer

The Data Point buffer is where test results are stored during a test (<F9>). The <F7> key re-graphs from this buffer, and the Save Test or Save Data commands copy the information from this buffer to disk. If a test sweep consists of more data points than the buffer can hold, a re-graph via <F7> will show only the number of points which the buffer holds even though all points appeared on screen during the <F9> sweep. Similarly, saving such a test to disk will save only the points from the start of the test up to the buffer size limit. Each measurement point during a test requires 13 bytes of memory; four bytes for the SOURCE-1 value, four bytes for DATA-1, four bytes for DATA-2 (whether or not DATA-2 is actually used in the particular test), and one byte for "overhead". If a test is set up for STEPS 20 at SOURCE-1, for example, there will actually be 21 data points (since data is taken at the START value in addition to each of 20 steps), and 21*13 or 273 bytes of the Data Point buffer will be filled.

28.5.5.6. Limit/Sweep/EQ File Buffer

The limit/sweep/EQ buffer area is loaded with data from all limit (.LIM), sweep (.SWP), and equalization (.EQ) files attached to the test (.TST) file presently in memory. These three file types may be thought of as cross-reference files and are attached by use of the NAMES command. S1.EXE software must look up values in these files at every step of a sweep. To avoid the slow operation which

would result if S1.EXE had to go to the computer disk for these values at each step, the data from those files is copied into this memory buffer area when the <F9> key is pressed to start a sweep. Each point requires 36 bytes of memory. If a sweep, limit, or EQ file is used which is longer than the buffer memory available, the test will be seen to slow down greatly at the point where the software must go to computer disk for each value instead of reading it from the memory buffer.

28.5.5.7. Edit Data Buffer

When the EDIT DATA menu command is used, S1.EXE software converts the data presently in the Data Point buffer from its normal, efficient binary format to a human-readable ASCII format and displays it on screen. The user may then choose to delete or modify values, typically as part of the process of creating limit files. When the user exits EDIT DATA mode with the <Esc> key, the edited ASCII data is converted back to the binary format and copied back into the Data Point buffer. Since ASCII data is quite inefficient, especially when formatted for convenient human reading and editing, 65 bytes of memory per Data Point is required for the Edit Data buffer.

28.5.5.8. Edit Procedure Buffer

System One procedures are ASCII files which are created, viewed, and modified in the Edit Procedure buffer. One byte of memory per character (including imbedded spaces, carriage returns, etc.) is required for the Edit Procedure buffer. A typical "one-screen-full" procedure may thus occupy 500 to 1,000 bytes, since many of the lines are usually short.

28.5.5.9. Edit Comment Buffer

Another ASCII buffer, entered by the EDIT COMMENT menu command, may be used to store miscellaneous notes and comments. These comments are saved to disk with the test data and test setup when the SAVE TEST command is used, and are printed underneath the graph in the normal "screen dump" (<*>) print-out mode. One byte of memory per character is required.

28.5.5.10. Edit Macro Buffer

The DCX-127 Multifunction unit includes the capability to initiate upon hardware switch contact any of eight different macros. This feature is useful in production test and QA activities, where non-computer-proficient operators may initiate different procedures or other actions by pressing a pushbutton or foot switch, rather than dealing with a full computer keyboard. The macros which are triggered are created, edited, and stored in the Edit Macro buffer. They are ASCII files, occupying one byte of memory per character.

28.5.5.11. Buffer Size Control

Available memory will normally be apportioned among these six buffer sizes according to built-in rules which are a compromise for "typical" operations. You can optimize the size of each buffer for your specific application by use of the /B command line option. The full form of this option is

S1 /Bn,n,n,n,n,n <Enter>

where each n is a number typed by the user. The sequence of these six numbers corresponds to the preceding discussion and to the format of the HELP screen display of these buffers. Thus, the first number specifies the number of Data Points which can fit in the buffer, the second number is the number of limit, sweep, and EQ file points which will be copied to memory for fast testing, etc. A special form of the /B option to maximize data points at the expense of all other buffers is

S1 /Bn

The result will be to load S1.EXE to permit n data points, setting all the other five buffers to the minimum permissible size, and leaving all remaining memory available for programs running during DOS and XDOS exits.

If the number entered for any buffer is above the maximum permissible, the error message "Invalid buffer sizes specification" will be displayed. It is possible to specify sizes for the various memory areas which add up to a large enough number that

MEMORY BUFFER AREA	TYPICAL DEFAULT SIZE	RANGE	BYTES PER	MEMORY USAGE RANGE (BYTES)	CONTROL OPTION
DATA POINTS	800 POINTS (10k bytes)	4-16000 POINTS	13 /PT	0 TO +207948	/B N,n,n,n,n,n
.LIM, .EQ, .SWP POINTS IN MEMORY	200 POINTS (7k bytes)	4-16000 POINTS	36 /PT	0 TO +575856	/Bn, N,n,n,n,n
EDIT DATA	48k CHARACTERS	64-65000 CHARACTERS	1 /CHAR- ACTER	0 TO +64936	/Bn,n, N,n,n,n
EDIT PROCEDURE	26k CHARACTERS	64-65000 CHARACTERS	1 /CHAR- ACTER	0 TO +64936	/Bn,n,n, N,n,n
EDIT COMMENT	26k CHARACTERS	64-65000 CHARACTERS	1 /CHAR- ACTER	0 TO +64936	/Bn,n,n,n, N,n
EDIT MACRO	6k CHARACTERS	64-65000 CHARACTERS	1 /CHAR- ACTER	0 TO +64936	/Bn,n,n,n,n, N
<ALT>F8 SCREEN IM- AGE MEMORY	VGA 38k bytes CGA 16k bytes EGA 28k bytes Hercules 33k bytes	ON OR OFF		+38k VGA +16k CGA +28k EGA +33k Herc	/8

Table 1 S1.EXE Memory Usage Above Minimum 367k (v2.10)

S1.EXE cannot load. In this case, you will receive an error message indicating that there is insufficient memory. You must then either reduce some of the allocations or see if there are memory-resident utilities which could be deleted. The /R option and the /B options may be used in conjunction as long as the requested sizes are compatible. If the intent is to reserve the maximum possible memory the /B option with minimum usable buffers will have that effect without use of the /R option. If the intent is to maximize data points at 16,000, for example, the /R option must also be used with a minimal set-aside or S1 cannot load.

28.5.5.12. Buffer Swap to Disk

The /&filename command line option is a powerful tool to allow large programs to run during XDOS and DOS exits without compromising the buffer sizes for data points, procedures, etc. This is accomplished by copying the contents of all six buffers to a disk file at each XDOS or DOS exit, then copying the disk file back into the buffer areas when returning to S1.EXE. The cost of this flexibility is speed. With typical buffer sizes set by the built-in rules, 5-10 seconds may elapse between the XDOS or DOS command and appearance of the DOS prompt which permits the next program to run. A similar length of time is taken at the end of the exit from S1.EXE to copy the disk file back into memory and erase the disk file. If the buffer sizes have already been reduced by use of the /B command, the time required will be proportionately less. If your computer has more than 1 Megabyte of memory and you have software which permits creating a virtual disk in that higher memory, the time to copy a normal set of buffers into that virtual disk may be as short as 1 second. To take advantage of such a virtual disk, the full path name must be specified for the "swap" file. For example, assuming the virtual disk to be D:, System One software might be started by

```
S1 /&D:\tempfile <Enter>
```

summarizes all the controllable memory areas and the command line options which control them. Multiple command line options may be used, separated by spaces. For example,

```
S1 /B30,6,2100,1000,200,64 /8 /&temp <Enter>
```

would control the six buffer sizes as specified, disable the screen memory, and swap all buffers to a disk file named "temp" during XDOS or DOS exits.

It is necessary to use the /R option to reduce the memory set aside for XDOS activity below 64k bytes if data points are to approach their maximum of 16,000, as might be required for long time records such as wow and flutter or phase versus time.

If /R and /B are used simultaneously, S1 may set aside more than the "R" value for XDOS activity since there is nowhere else to put surplus memory after the /B command rigidly defines all six buffers.

28.5.6. Screen Appearance of Punched-Out Fields

Panel set-up fields which have been blanked or punched out and saved as xx.OVL files can have different screen appearances. Monochrome display systems provide several choices, while color systems provide 256 choices of appearance. The choice of appearance can be specified on the command line by the V (video) option. For example, to cause punched-out fields to be completely blank, type at start-up

```
S1 /V0
```

See the PROCEDURES chapter for an explanation of the control technique and choices.

28.5.7. Printer Mode and Printed Graph Size Selection

S1.EXE software can be configured for a number of different printer dot densities and print modes. It can also be loaded so as to print graphs of any desired size, and the graphs may be rotated 90 degrees if desired. The /P#,#,# option controls these functions. See the description beginning on page 15-5.

28.5.8. Formatting of Graph Printout

Normal operation of System One's graphic print-out mode, initiated with the <*> key, assumes that two graphs per page are desired. Thus, following the first graph and comments, line feeds are issued to the printer to move to approximately the center of the page. Following the next graph printed, a page feed command is issued to the printer.

When this type of formatting is not desired, System One should be started with the command line option

```
S1 /F
```

which disables the formatting. The printer will simply stop after the last line of comments or the bottom of the graph if no comments are present. Furthermore, the graph will be located at the left-hand margin of the page rather than centered horizontally. For more details on the /F option including numeric arguments to cause bi-directional or uni-directional printing, see page 15-3.

28.5.9. Plotter and Laser Printer Compatibility

System One software can save the information necessary for an HPGL-compatible plotter, HP Laserjet laser printer, or Postscript-compatible laser printer. After starting S1.EXE with the /G option, the information may be saved into a user-named file with the .GDL (Graphics Data List) extension. After exiting from S1.EXE, a driver program called PLOT.EXE (for HPGL-compatible plotters and HP Laserjet printers) or POST.EXE (for Postscript-compatible printers) must be run. These programs define plotting parameters, specify a .GDL file as input, and make the plot. See the plotter section on page 15-7 of the HARD COPY PRINTOUT chapter for full information.

28.5.10. Command Line Query

If S1 /? or S1 /HELP is typed from DOS, a brief summary will be presented on the screen of the available command line options for starting S1.

28.5.11. Batch Files for Loading S1.EXE

Since it can be time-consuming and error-prone to type in the buffer option command each time you start System One software, a DOS batch file may be written to take over this task. Use of the DOS environment is often an even better solution; see the section immediately below for a discussion of this technique.

To make a batch file, use Edit Comments to create a command line as desired. For the buffer size example given above, the line would thus be:

```
S1 /B 100,30,64,6000,200,200 <Enter>
```

Press <Esc> and Save Comments. Supply a simple name such as SYS1.BAT. You must type the .BAT extension, otherwise the standard .TXT extension of Comments files will be furnished. In the future when starting System One from DOS, you can type:

```
SYS1 <Enter>
```

The batch file will execute, loading System One software with the buffer sizes specified. You could create several different batch files with different names and different buffer sizes for various applications. If you prefer to stay with your present habit of starting System One by:

```
S1 <Enter>
```

you must first rename S1.EXE to another name by use of the DOS RENAME command. If you choose to rename S1.EXE to REAL_S1.EXE, for example, the command from DOS is:

```
RENAME S1.EXE REAL_S1.EXE <Enter>
```

The batch file would then be:

```
REAL_S1 /B 100,30,64,6000,200,200 <Enter>
```

and it would be saved under the name of S1.BAT. Typing:

```
S1 <Enter>
```

will then execute the batch file S1.BAT which in turn calls the renamed System One software with the buffer option.

After System One software loads, select the Help panel and you should see a display similar to Figure 28-4. The size of the six areas will be as you specified on the command line. Note that the copy buffer (accessed by F6 and F5 keys) of each editor is also part of the size assignment. For example, if 2,000 bytes is reserved for Edit Comments and a 500-byte section of text has been deleted into the copy buffer with the F6 key, there will only be 1,500 bytes remaining into which a new Comments file could be loaded. To empty the copy buffer of any editor, select the editor and press F6 twice without moving the cursor. This copies a zero-length "text" into the copy buffer, effectively erasing the previous contents.

The last line, "Bytes Reserved for DOS", will show the remaining computer memory usable for other program operation under a System One shell during XDOS and DOS exits. The exact amount of remaining memory will depend on the memory size of the computer, on the DOS version in use, and on whether any memory-resident programs were loaded before S1. Examples of memory-resident programs are MOUSE.COM, GRAPHICS.COM, HGC.COM, and utilities permitting instant access to simulated index cards, calendars, calculators, etc.

28.5.12. Using the Environment to Control Start-Up

An alternative to use of batch files is to issue from DOS a "SET S1OPTS" statement. Such a statement writes into a DOS memory area called the Environment. Each time S1.EXE is started, it looks into that Environment area to see which command line options it should execute when loading. This technique has an advantage over the batch file approach in that S1.EXE need not be re-named to avoid conflict with a batch file named S1.BAT, if you prefer to stay with your habit of starting the software via S1 <Enter>. The SET S1OPTS statement

can be included in the AUTOEXEC.BAT file for maximum convenience. An example SET S1OPTS statement would be:

```
SET S1OPTS=/B100,6,64,2000,2000,64 /D2 /L
```

The present contents of the Environment can always be viewed from DOS by typing SET <Enter>.

Note that any options included on the command line when S1 is started will add to or over-ride options specified by the Environment.



29. MOUSE OPERATION

29.1. Introduction

The Microsoft Mouse provides an alternate to the arrow keys, <+> and keys, space bar, and <Enter> key for moving around the panel and making selections. The mouse also permits smooth, analog-like control of the generator amplitude and generator frequency.

29.2. Mouse Compatibility, PCI-1 Card

Audio Precision has built three versions of interface card. The original version, the PCI-1, contained connectors both for the digital interface cable to System One and for the original version of the Microsoft bus (parallel) mouse. This version of the mouse, with a 9-pin D subminiature connector, is no longer available. A custom integrated circuit required on the PCI-1 card to support the bus mouse is also no longer available. The PCI-1 card contained circuitry at the same I/O address used by the bus mouse. The newer version bus mouse cannot be used when this card is installed due to I/O address conflict.

With recent versions of MOUSE.COM, the program can be loaded so that it will look only for a serial mouse at a specific serial port. A serial mouse and this version of MOUSE.COM can be used in conjunction with the PCI-1 card. The command to invoke the software is

```
MOUSE /C1
```

if the serial mouse is connected to COM1:, or

```
MOUSE /C2
```

if the serial mouse is connected to COM2:

29.3. Mouse Compatibility, PCI-2 Card

Audio Precision is now furnishing the PCI-2 and PCI-3 cards. The result is that either bus or serial mice may be used with System One.

29.3.1. PCI-2 Installation with Bus Mouse

The bus mouse is normally sold with its own interface card which installs into an empty expansion slot of the personal computer. The PCI-2 card installs into another empty slot. When both bus mouse and the Audio Precision PCI-2 card are to be installed, jumpers on the PCI-2 card must be moved to one of three other addresses available to avoid I/O address conflict with the bus mouse card. See the PCI-2 card preparation section of the Installing the Interface Card chapter for more details.

29.3.2. PCI-2 Installation with Serial Mouse

The serial mouse plugs onto a serial (RS-232) connector. The PCI-2 card contains a serial port in addition to the digital interface connector to System One. Thus, a computer with no available serial port can support a serial mouse via the PCI-2 card. (Note, however, that a maximum of two serial ports are permitted by the IBM-PC and compatible architecture.)

The PCI-2 card is shipped without this serial port being enabled. To enable the port and configure it as COM1: or COM2:, jumpers must be correctly set at P121 and P421. See the Installing the Interface Card chapter for more details.

29.4. PCI-3 Installation with Mouse

The PCI-3 card is designed for the Microchannel Bus in the more powerful models of the IBM PS/2 series. This card operates at a fixed address assigned to Audio Precision by IBM and will not conflict with either bus or serial mice.

29.5. Mouse Software Installation

Software installation of the mouse consists of running the program MOUSE.COM each time the computer is started. The most convenient way to accomplish this is by including the command MOUSE in an AUTOEXEC.BAT file, and copying the program MOUSE.COM onto the disk with the AUTOEXEC.BAT file which will be used to start the computer. MOUSE.COM will be furnished by the mouse supplier.

29.6. Mouse Usage

In panel mode, the mouse controls the location of the cursor on the computer screen. Rolling the mouse along its long axis will move the cursor up and down within a given panel section. Rolling the mouse perpendicularly to its long axis moves the cursor between fields on the same line within a panel section, or between panel sections. Just as with the arrow keys, when the cursor moves between panel sections it jumps to the field it last occupied in that panel.

When the mouse-controlled cursor is located on a multiple-choice field, the left and right mouse buttons can be used to move the "choices" cursor left or right, just as the <+> and keys on the keyboard. Pressing both buttons simultaneously then selects the current choice, just as pressing the <Enter> key does. When the cursor is located on either the generator dBr REF field or the analyzer dBr REF field, pressing either the left or right mouse button will transfer the current amplitude value to that field as the new dBr REF, just as pressing the <+> or key will. Similarly, the cursor can be positioned on either the AMPLITUDE numeric field or the AMPSTEP numeric field and the amplitude in-

cremented with the right mouse button or decremented with the left mouse button. FREQUENCY and FREQSTEP incrementing and decrementing work similarly.

If neither left nor right button has been pressed to start scanning through the choices, pressing both buttons simultaneously has the same effect as the <Esc> key, taking you to the top level (COMMAND) menu. Once the mouse is on the COMMAND line, the cursor is moved among the commands by rolling the mouse and the current command is selected by pressing either left or right mouse button.

30. COMPUTER MONITOR NOISE FIELDS

Cathode ray tube monitors of computers produce strong magnetic fields. Noise can be induced at two frequencies: approximately 60 Hz from the vertical sweep, and at the horizontal sweep frequency, which is 15.75 kHz for CGA-compatible color monitors, approximately 18 kHz for most monochrome monitors, and somewhere in the 16-32 kHz area for most display systems. System One is quite well shielded to reduce its pickup of such noise to acceptably low levels under nearly all circumstances. The device under test and audio interconnection cables, however, may not be effectively shielded against such fields. The simplest solution to preventing monitor magnetic field pickup in the device under test is to maintain adequate physical space between them. Magnetic shielding materials may be helpful if it is impossible to position the monitor far enough from the device under test to eliminate the problem.

One of System One's capabilities makes it easy to identify this problem and experiment with spacing or shielding until it is solved. This is done via a BANDPASS mode sweep from approximately 100 or 50 kHz through 20 Hz. The graphic result is a plot of the spectral distribution of noise. Any excessive noise induced into the device under test will produce a noticeable "hump" in the curve at either the vertical or horizontal sweep frequencies. Repeated sweeps can be made between changes in physical spacing, equipment location, or shielding until a satisfactory installation is obtained. See Figure 30-1 for an example of such a test on a graphic equalizer, placed close to a CGA computer monitor (color monitors generally have the strongest fields). Note the noise peaks at 60 Hz (power mains frequency), 120 Hz, 180 Hz, 240 Hz, and 300 Hz. Odd harmonics generally indicate magnetic coupling; even harmonics are normally due to insuffi-

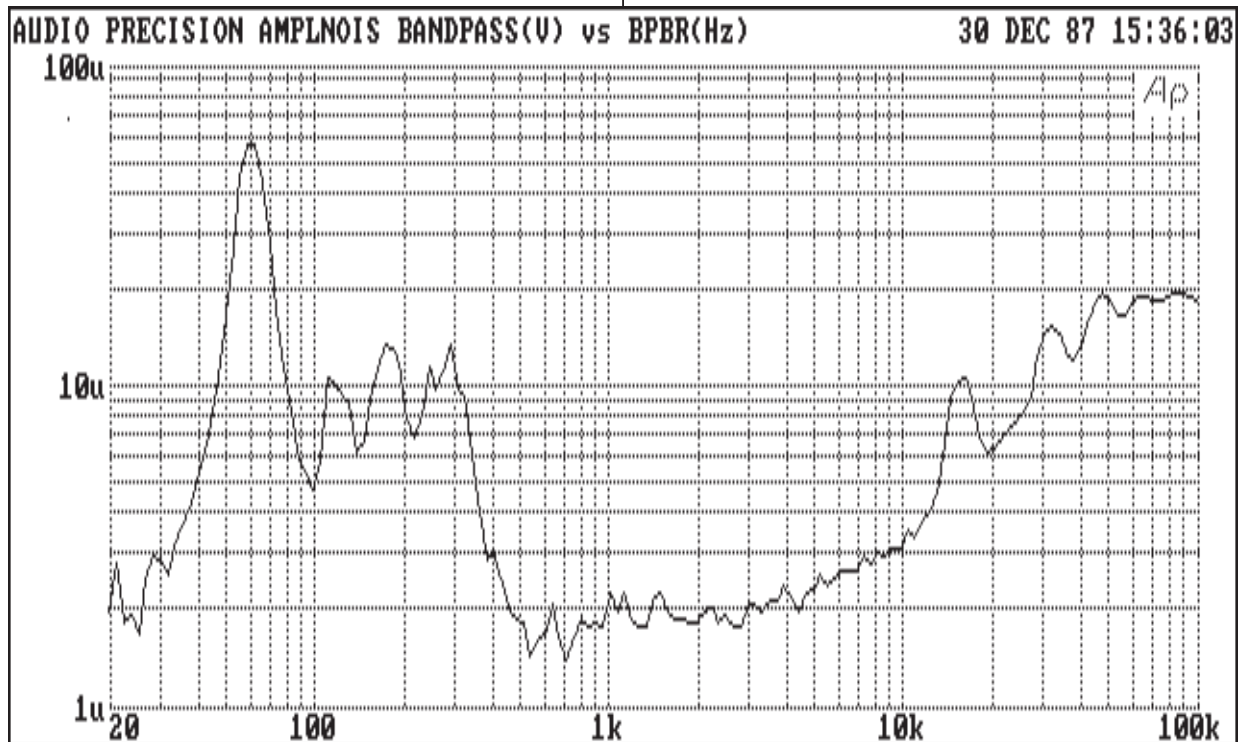

Figure 30-1 Residual Noise Sweep Showing Monitor Noise

cient filtering of a full-wave power supply in the device under test. The noise peak at about 15 kHz (with harmonics at 31 kHz and 47 kHz) is due to magnetic coupling of the horizontal sweep signal from the computer crt monitor.

31. AUDIO TESTING

31.1. Introduction

The majority of audio testing consists of either amplitude (level) measurements or measurements of the effects of non-linearity. Other categories of audio measurements include phase, frequency, and wow and flutter. The concepts behind most common audio measurements will be discussed in this chapter, along with specific advice on how to make these measurements with System One. In many cases, this chapter will refer to standard tests prepared for System One and distributed on diskette with the software.

31.2. Amplitude or Level Measurements

Examples of amplitude measurements include gain, loss, power, frequency response, noise, signal-to-noise ratio, and many acoustical device measurements.

The equipment required for most amplitude measurements consists of a sine wave generator and a flexible ac voltmeter with a selection of filters and detectors. Most amplitude measurements are stimulus-response measurements. Stimulus, usually from the generator output, is applied to the input of the device under test (DUT). The analyzer (voltmeter) measures the resulting output. For devices which are not real-time amplifiers, such as compact disc players, tape machines in playback mode, and record players, the stimulus may consist of a test disc or tape previously prepared by recording test signals on it, rather than the output of a generator. For noise measurements (except for quantization noise in digital systems), stimulus will not be used during noise measurements. Instead, the input of the device under test is back-terminated in its specified source impedance and the internally-generated noise amplitude is measured.

When the signal for amplitude measurements is a sinewave at least 20 dB above the internal noise of the device under test, neither the bandwidth nor the detector type of the analyzer is highly critical. Either true rms or average-responding, rms calibrated detectors will give essentially the same results. Neither noise-weighting nor bandwidth-limiting filters should be used if they have significant effect on the amplitude flatness and accuracy of the analyzer at any of the stimulus frequencies to be used.

31.2.1. Frequency Response

Frequency response measurements are most commonly made by stepping or sweeping a sinewave oscillator, at a fixed amplitude, across the spectrum of interest. The resulting output amplitude of the device under test (DUT) at each frequency is measured with the analyzer. Frequency response is usually stated in terms of dB variation from some reference midband frequency. In certain applications, it may be desired to measure frequency response at a constant output amplitude from the device under test. In this case, the generator amplitude may require adjustment at each frequency. The test results then will consist of the final adjusted value of generator amplitude required at each frequency for constant output from the device. The generator amplitude will normally be graphed inverted in this case, to provide a conventional frequency response graph.

The test file FREQRESP.TST on the Tests and Utilities diskette is a typical stimulus-response frequency response test for balanced-input line level devices. Loading the test, pressing the <F4> key to establish the midband reference value, and pressing <F9> for the test will result in a graphed measurement.

The test may be easily modified, and the resulting modified versions saved under other names supplied by the user, for other types of devices. The

frequency range or direction of sweep can be changed from the 20 kHz-20 Hz range stored by entering new values for START and STOP under SOURCE-1 GEN FREQ on the SWEEP (F9) DEFINITIONS panel. If the device has rapid changes in response and better resolution is desired, increase the number of STEPS from the value of 30 entered near the bottom of the SWEEP (F9) DEFINITIONS panel.

If a stereo device is to be tested, select STEREO instead of DATA-2 on the SWEEP (F9) DEFINITIONS panel and select ANLR RDNG following STEREO as the parameter to be plotted. If the device is not line level input, change the AMPLITUDE of the generator (GENERATOR panel) from 0 dBu to the desired level. If the device input is unbalanced rather than balanced, change the generator output configuration from BAL to UNBAL. If the +/-5 dB provision of the graph vertical scales is not appropriate, change the GRAPH TOP and BOTTOM values as desired. If the data should be settled to tighter than 0.1 dB repeatability before plotting, change the AMPL TOLERANCE on the SWEEP SETTling panel from 1% (approximately 0.1 dB) to an appropriate smaller value. COLORGRAPH or TABLE displays may be selected as desired.

Frequency response measurements on equalizers typically graph well with GRAPH TOP and BOTTOM values of +/-15 dB. Between 50 and 100 step sweeps usually provide adequate resolution for equalizer testing.

31.2.2. Frequency Response at Constant Output Amplitude

FREQ-CON.TST is a test file prepared for applications where frequency response must be measured at constant output amplitude from the device under test. Proof-of-performance testing of broadcast transmitters and stations is one application for this type of testing. Such testing techniques may be required by regulatory agencies due to the pre-emphasis characteristics of many frequency modulation and tv aural transmitters, which would produce widely varying frequency deviation levels and possi-

ble over-deviation if sweeps were run at constant generator amplitude. These techniques have also been required due to the typical non-linear characteristics of some amplitude modulation transmitters at high modulation levels.

FREQ-CON.TST uses the REGULATION mode of System One to automatically adjust the generator amplitude at each step of a frequency sweep so as to produce a constant measured output amplitude from the device or system under test. After achieving the constant amplitude at each frequency step, FREQ-CON.TST will then plot (inverted) the final generator amplitude which was required to achieve the regulated level. FREQ-CON.TST is initially set up to regulate for a constant 1.000 Volt amplitude from the device under test. Replace this value on the TO line of the REGULATION panel with the desired target voltage.

For broadcast station testing, the target will be the output voltage from the station modulation (deviation) monitor at the specified percentage of modulation for the measurement. Note that this must **not** be a de-emphasized output in the case of a frequency modulation monitor. The generator HI and LO BOUND values on the REGULATION panel may have to be changed depending on whether the generator is feeding a microphone level input, line level input, or the transmitter input directly. The DATA-1 GRAPH TOP and BOTTOM values on the SWEEP (F9) DEFINITIONS panel will need to be changed correspondingly. If it is desired for the graph to pass through 0 dB at a mid-band frequency value such as 1 kHz, the DATA-1 units can be changed to dB, a single regulation cycle initiated with <Ctrl><F3> while the GENERATOR panel FREQUENCY is set to the desired reference frequency, and <F3> then pressed to transfer the generator amplitude to the generator dBr REF field.

31.2.2.1. Testing Pre-Emphasized Transmitters

When testing pre-emphasized broadcast transmitters and stations, it may also be desirable to attach the appropriate xx.EQ de-emphasis curve to FREQ-CON.TST and to select EQSINE waveform on the GENERATOR panel. The ultimate measured re-

sults will be the same with or without de-emphasis applied to the generator. However, the first amplitude setting at each new frequency of the sweep, before the regulation cycle begins, will be corrected by the de-emphasis curve. The amplitude will thus be closer to the correct value, producing smaller transients during testing. Both 75 microsecond (75US_DE.EQ) and 50 microsecond (50US_DE.EQ) de-emphasis curves are stored on diskette for U.S. and European broadcasting standards.

31.2.3. Frequency Response of Compact Disc Players

Two forms of test signals on CD test discs are suitable for frequency response testing of CD players. One is a continuous analog sweep (glide tone); the other is a series of tracks recorded at different frequencies but the same amplitude.

The test file CDPHASE.TST is provided for use with analog-swept signal tracks such as track 65 on the Denon Audio Technical CD test disc 38C39-7147 or track 41 on the Japan Audio Society Audio Test CD-1 test disc YDDS-2. CDPHASE.TST is an EXTERN FREQ test set up for an increasing-frequency swept signal. The test as set up measures frequency response of the left channel and interchannel phase. By deleting the PHASE selection as DATA-2, the test could be used for frequency response on track 2 (left channel) or 3 (right channel) of the Philips Audio Frequency Test Sample Number 3 test disc 410 055-2.

To run CDPHASE.TST, load the test and select PANEL mode. Select the track on the test CD with the sweep. All three of the test CDs have a short section of 1 kHz reference tone before the beginning of the sweep. Start the CD player while System One is in PANEL mode, press <F4> as soon as the 1 kHz signal readings appear on the panel displays, then press <F9>. The test should continually acquire and plot data. Pressing <F4> sets the zero dBr REFERENCE to the 1 kHz amplitude (left track in the case of stereo tests) so that the graph will pass through 0 dBr at midband. Since the amplitude of the swept tone is quite different on the three discs (0

dB on the Philips, 15 dB on the Denon, 20 dB on the JAS), the data is likely to plot off the top or bottom of the graph if the <F4> dBr REFERENCE setting is not done properly. After a test is complete, the GRAPH TOP and BOTTOM values on the SWEEP (F9) DEFINITIONS panel can be changed if desired to best display the data, with the data then re-graphed with the <F7> key.

With hardware after serial number 20300, it is possible to measure frequency response on both channels simultaneously with a glide-tone signal. AVCDFRQ1.TST is set up for this purpose and may be used as described above with the JAS or Denon test discs. AVCDFRQ1.TST uses 2-CHANNEL function to measure the left channel with the READING meter and the right channel with the LEVEL meter.

CDFREQ2.TST was set up for the case of a sequence of tracks in order of ascending frequency, each with a fixed frequency signal. Examples are tracks 4 through 16 on the Technics CD Test Disc Volume 1 (SH-CD001), tracks 46 through 55 on the Denon disc, tracks 2 through 13 on the Sony Test CD Type 3 (YEDS 7) test disc, and tracks 8 through 38 on the Japan Audio Society disc. Since most test discs have a duration of 20 to 60 seconds (the JAS disc is only 10 seconds) on each of these tracks, the most efficient process is usually to manually advance the CD player to the next track as soon as System One acquires the data from the current track. System One, in EXTERNAL SWEEP mode, signifies that it has acquired data by sounding a "beep" from the computer. To run the test, load it, select the starting track on the test CD, press <F9>, and then advance the CD player one track each time the computer beeps. Setting the dBr REFERENCE value can be done by first selecting a mid-band (usually 1 kHz) track and pressing <F4> before going to the beginning of the sequence of tracks. GRAPH TOP and BOTTOM can be changed after the test is completed to best display the data, using <F7> for the re-display.

With units after s/n 20300, AVCDFRQ2.TST may be used for frequency response testing with the tracks just described. It differs from CDFREQ2.TST in that it uses 2-CHANNEL func-

tion to measure and plot both channels simultaneously, rather than the CDFREQ2.TST technique of STEREO mode to sequentially switch the READING voltmeter back and forth between channels on each track of the test disc and then plot both measurements simultaneously. AVCDFRQ2.TST will thus run somewhat faster than CDFREQ2.TST if a unit above serial 20300 is being used.

31.2.4. Frequency Response of Tape Recorders and Players

The testing technique appropriate for tape machine testing depends on whether the machine has two or three heads.

31.2.4.1. Three Head Machines

Three head machines can usually record and play simultaneously, though with a time delay between recording and playback. The time delay depends on the tape speed and the distance between the record head and the playback head. The test 3HD-FREQ.TST was set up for frequency response testing of professional tape recorders. Load the test, put the tape machine in record mode and monitoring from the reproduce head, press <F4>, and then press <F9>. The test is set up to measure both channels of a stereo recorder, sweeping each channel from high frequency to low. AV3HDFRQ.TST is a similar test which takes advantage of the 2-CHANNEL function of A version hardware. AV3HDFRQ.TST measures both stereo channels with a single sweep of the generator. It is set up with more points for finer response detail.

3HD-FREQ.TST assumes that the machine is set up for +4 dBu as its "0 VU" input level. If this is not appropriate, enter a new value into the AMPLITUDE field of the GENERATOR panel. The test is set for a 30 kHz to 20 Hz sweep; other values may be entered as START and STOP under SOURCE-1 on the SWEEP (F9) DEFINITIONS panel. The SETTling DELAY value on the SWEEP SETTling panel, initially 250 milliseconds, may need to be adjusted for various machines. Measure the distance between the gaps in the record and reproduce heads and divide that amount by the tape

speed. For example, if the distance is 2 inches and the tape speed is 15 inches per second, the delay will be 2/15 of a second or approximately 130 milliseconds. Enter a marginally larger number into the SETTling DELAY field so that the software will not start applying settling criteria to the measured data while the last portion of tape recorded at the previous frequency step is still passing by the reproduce head.

31.2.4.2. Determining Tape Recorder Delay

If you wish to experimentally determine the minimum acceptable SETTling DELAY for use with a 3-head tape recorder, load the test 3H-DELAY.TST. This test is an amplitude sweep from -20 dBu to 0 dBu in 2 dB steps, while measuring the output amplitude from the tape machine. The stored value of SETTling DELAY is 1 second, adequate for any but the slowest-speed recorders. Run this test <F9> while the tape machine is in record mode, monitoring from tape. The result should be a diagonal line from lower left to upper right of the screen. Press <Alt><F8> to store this image. Now, reduce the SETTling DELAY to a short value such as 100 milliseconds, press <F8> to restore the image, and press <F9> to run a new test graphing onto the stored image. If the delay is too short, many or all measured points will be plotted to the right of the reference line. This is due to System One measuring and settling on the amplitude from the previous step, on tape which was still in transition between the two heads, but plotting at the horizontal point corresponding to the new generator amplitude. Experimentally adjust SETTling DELAY to the minimum value which results in all data plotting on top of the reference line. Add a small safety margin to then provide reliable data in the shortest possible test time.

31.2.4.3. Two Head Machines

Two head machines have a shared record-playback head and thus cannot record and play simultaneously. They must be tested in playback mode with a previously-recorded test tape containing

sweeps or a sequence of fixed-frequency tones. The test tape may be a purchased reference tape, or may be recorded by use of System One.

31.2.4.4. Recording a Test Tape

Use the test file 2HD-RCRD.TST to record an appropriate test sequence to later be used in playback testing. 2HD-RCRD.TST records a 30-step sweep from 20 Hz to 20 kHz on both tracks of a stereo machine. It is set up for consumer machines which normally have unbalanced inputs. Most consumer-grade tape machines, especially cassette machines, will saturate the tape at high frequencies when recording at levels much higher than 20 dB with respect to zero VU. Since recording level indicators seldom have much resolution at 20 VU, the preferred level setting technique is to first make recording level adjustments at zero VU, then reduce the generator level by 20 dB before making the recording. 2HD-RCRD.TST is set up with 0 dBV (1 Volt) as the generator AMPLITUDE. Load this test, set the recording level for 0 VU, and then change GENERATOR AMPLITUDE to -20 dBV to record a tape which will be used for frequency response or phase testing. If the tape will be used for testing THD+N versus frequency, -20 dBV is too low in amplitude and will produce noise-limited distortion measurements. The best recording level for distortion measurements will probably be between 0 and -10 dBV.

Professional two-head machines such as videotape and videocassette recorders normally have balanced inputs and outputs. 2HD-RCRD.TST is easily modified for professional balanced machines by changing the GENERATOR panel from UNBAL to BAL. You will also normally wish to change the generator AMPLITUDE from 0 dBV to +4 dBu, the most common zero VU reference level on professional machines. Tape saturation is not normally a problem on professional machines at 0 VU and below, so it will not be necessary to reduce the generator amplitude after adjusting the tape machine input level controls for 0 VU and the same recording may be used for both frequency response and distortion playback tests.

Start the machine in record mode; let it run past any tape leader and for several seconds more, thus recording a portion of reference level tape at 1 kHz which can be used to set the <F4> reference during playback. Press <F9> to start the frequency sweep. SETTling DELAY is set to 1.5 seconds, so the generator will dwell on each frequency step for 1.5 seconds before moving to the next step. This will allow sufficient time for frequency response, phase, or THD+N versus frequency measurements in EXTERNAL FREQ mode during playback, using tests described below.

31.2.4.5. Playback Frequency Response

The test 2HD-FREQ.TST is designed for use in playback frequency response measurements, using either a tape recorded with 2HD-RCRD.TST or a purchased reference tape with a series of tones across the audio spectrum in order of increasing frequency. Such reference tapes are usable even if they have voice announcements between the tones, since the settling algorithm will ignore the constantly-changing voice signal but will measure and plot the stable tone signal. Load the test, go to PANEL mode, and start the tape playing. If there is a midband reference portion, press <F4> while it is playing to set the ANALYZER dBr REFERENCE value. Press <F9> and the frequency response of both channels should plot as the tape plays.

Analog tape machines have significant flutter, which produces frequency modulation of recorded tones. They also have amplitude variations in the signal, particularly at high frequencies. Since 2HD-FREQ.TST runs in EXTERNAL FREQ mode and measures the frequency of the signal from the tape, these frequency and amplitude variations can make it difficult to collect data at high frequencies. The FREQ TOLERANCE parameters (SWEEP SETTling panel) of 2HD-FREQ.TST are looser compared to most other testing situations and both DATA SAMPLES and SOURCE SAMPLES have been set to 2 to improve the ability to measure the noisy data from tape. On poor machines, these values may need to be loosened still further. On professional machines, they may be tightened to increase the repeatability of data.

31.2.5. Gain and Loss

Gain or loss are measured by applying an input signal within the linear range of a DUT, and measuring and stating the output level with reference to the input level. If the device is linear, it is not important for the measurement to be made at a specific level since the gain or loss will be constant across the linear range.

GAIN.TST is supplied to measure gain or loss on a DUT. It is set up for balanced input devices whose useful output range including the area around line level (0 dBu, or 0.7746 Vrms). If the DUT to be tested is linear and not noise limited at 0 dBu output levels, the test can be run unmodified by loading it, pressing <Ctrl><F3>, and then pressing <F9> after the REGULATION cycle of <Ctrl><F3> has completed. The starting point for generator output is 60 dBu which is appropriate for microphone input levels. REGULATION mode will function, triggered by pressing <Ctrl><F3>, by “searching” with the generator output amplitude until the DUT output level is brought to 0 dBu. The test, triggered by <F9>, will then display the generator amplitude. Since the device output is 0 dBu, the gain or loss is the generator amplitude with the algebraic sign inverted.

GAIN.TST will measure gain at 1 kHz but can be modified to another frequency by changing the generator FREQUENCY. For unbalanced DUTs, the generator output configuration should be changed from BAL to UNBAL. If 0 dBu is not comfortably within the linear and noise-free output range of the DUT, change the dBr REF values on both the GENERATOR panel and the ANALYZER panel to a more appropriate figure. Changing both dBr REF values is required since both the REGULATION panel and the DATA-1 display use dBr units so that device gain can be directly read without further computations.

Remember that source and load impedances have a significant effect on the gain or loss of most DUTs. Therefore, select the appropriate OUTPUT impedance on the GENERATOR panel to match the source impedance that the DUT is normally used with. Be sure that the DUT output is loaded with

the correct value of load resistance. 150 and 600 Ohm values may be selected on the ANALYZER panel; any other values must be supplied externally and used with the 100k selection of analyzer input impedance.

31.2.6. Signal to Noise Ratio

Signal-to-noise ratio, as a relative measurement, must be made with reference to a specific output amplitude from the device under test. The rated DUT output amplitude must therefore be calibrated as the 0 dBr reference of the analyzer. The stimulus (if used for calibration) is then removed and the DUT input back-terminated with the source impedance it is usually driven from. The DUT residual output amplitude (noise) is then measured and expressed in dB relative to the reference. Since the measured value is noise, a true RMS detector must be used. Measurement bandwidth will strongly affect the measurement and must be specified. Noise weighting filters are sometimes used in order to obtain numbers which correlate well with human observations.

SIGNOISE.TST is furnished to make signal-to-noise ratio tests on stereo or monaural devices. Before use, the ANALYZER dBr REFERENCE value must be set to the rated DUT output amplitude for signal to noise ratio measurements. Load SIGNOISE.TST, go to the ANALYZER panel, and enter the DUT rated output amplitude (in any of the available units such as Watts, Volts, dBu, etc.) as the dBr REFERENCE value. If the DUT output is rated in Volts or dBu, no other entries need be made. If the DUT is rated in dBm or is a power amplifier rated in Watts, you must both enter the power value as the dBr REFERENCE and also change the dBm/WATTS REFERENCE value on the next lower line to the value of load resistance into which the amplifier is working. After changing these reference values, press <F9> for the test. The value will be expressed in dBr (dB relative) and will be a negative number; that is, a 75 dB S/N ratio will be expressed as -75.00 dBr.

SIGNOISE.TST is initially set up with a 22 Hz-22 kHz bandwidth; the bandwidth can be changed to other values on the ANALYZER panel. If a weighted measurement is desired, select the weighting filter on the FILTERS line. The back termination for the DUT is 50 Ohms as originally set up; this can be changed to 150 or 600 Ohms as required.

31.2.7. Absolute Noise Tests

SIGNOISE.TST may be easily modified to an absolute noise level test rather than a signal-to-noise ratio test, merely by changing the DATA-1 and DATA-2 units from relative dB (dBr) to an absolute unit such as dBu or Volts.

31.3. Non-Linearity Tests

The effects of device non-linearity may be tested by several distortion measurement methods. System One is capable of THD+N (total harmonic distortion plus noise), of individual harmonic distortion at spot frequencies by use of optional bandpass filters, and of intermodulation distortion testing by the SMPTE, CCIF, and DIM/TIM standards. Distortion testing is commonly done both as a function of amplitude and of frequency.

31.3.1. Harmonic Distortion Concepts

Harmonic distortion may be measured and expressed as individual harmonic amplitudes, as total harmonic distortion, and as total harmonic distortion plus noise (THD+N). In all cases, stimulus from a very pure sinewave generator is fed to the input of the device under test. The generator must have significantly lower distortion than that of the DUT, since there is no way to separate generator distortion from DUT distortion at the DUT output and the two may actually cancel to produce an erroneously low reading.

Individual harmonic amplitude measurements may be made with a heterodyne spectrum analyzer or digitizer plus FFT software. The resulting high

selectivity separates the measurement of a selected harmonic component from the fundamental, adjacent harmonic components, and wideband noise. System One can measure the amplitude of a few individual harmonics by using optional fixed-frequency bandpass filters in addition to the fundamental rejection of THD+N mode. The notch filter in THD+N mode eliminates the fundamental frequency, and selecting an optional bandpass filter at the 2nd or 3rd harmonic provides a measurement of the amplitude of that particular harmonic.

The term total harmonic distortion (THD), properly used, refers to measurement methods which individually measure the amplitude of each significant harmonic in a narrow measurement bandwidth, then combines them in root-mean-square fashion to produce a single number. Total harmonic distortion plus noise (THD+N), on the other hand, refers to the measurement technique in which the fundamental component is removed by a bandreject (notch) filter and all remaining energy measured, including harmonics and noise. The majority of modern audio analyzers are of the THD+N architecture. The terminology distinction between THD and THD+N is relatively recent, however, so many audio analyzers designed prior to about 1980 which use the THD terminology are really THD+N analyzers.

31.3.2. SMPTE/DIN Intermodulation Concepts

The SMPTE (and the very similar DIN) technique of intermodulation distortion measurement uses a low frequency tone combined in a 4:1 peak amplitude ratio with a high frequency tone. The SMPTE standard specifies 60 Hz and 7 kHz for the two frequencies. The DIN standard allows several choices; 250 Hz and 8 kHz is a frequently-used combination. The analysis technique involves measuring the amplitude modulation of the high frequency tone caused by the low frequency tone as they pass through a non-linear device.

31.3.3. CCIF Intermodulation Concepts

The CCIF intermodulation distortion testing technique is also variously referred to as the IHF-IM method, the twin-tone method, and sometimes the difference-tone method. The stimulus consists of two relatively-closely spaced tones of equal amplitude, usually at high frequency. Common combinations are 13 kHz and 14 kHz, or 19 kHz and 20 kHz. System One's implementation of this test measures only the amplitude of the second-order difference product which falls at a frequency equal to the frequency difference between the two stimulus tones.

31.3.4. DIM/TIM Intermodulation Concepts

Several dynamic intermodulation distortion or transient intermodulation distortion testing techniques have been proposed. The most popular presently uses a stimulus consisting of a squarewave and a sinewave. A standard is expected in the near future to specify a 3.15 kHz squarewave except in 15 kHz band-limited broadcasting systems, where a 2.96 kHz squarewave will be used. The squarewave is combined with a relatively high frequency sine-wave ("probe tone"), and some of the resultant intermodulation products are isolated and measured. System One's implementation of this technique is a simplified method in which only the imd products folding down below the squarewave frequency are measured.

31.3.5. Distortion Versus Amplitude

THD-AM.TST, SMPTE-AM.TST, CCIF-AM.TST, and DIM-AM.TST are all amplitude sweeps for measuring the results of device non-linearity as a function of amplitude. THD-AM.TST measures total harmonic distortion plus noise at a signal frequency of 1 kHz as a function of amplitude, but can be easily changed to any other frequency. SMPTE-AM.TST uses the standard SMPTE test conditions of a 60 Hz low frequency tone mixed in a 4:1 amplitude ratio with a 7 kHz

high frequency tone, but either frequency may be changed and the amplitude ratio may be changed from 4:1 to 1:1. CCIF-AM.TST uses two equal amplitude tones at 13 and 14 kHz, but other frequency spacing values are available and any center frequency above 4 kHz may be used. DIM-AM.TST uses the DIM-30 test signal consisting of a 3.15 kHz squarewave, band limited to 30 kHz, combined in a 4:1 peak amplitude with a 15 kHz sinewave. Two other variations of DIM and TIM testing (DIM-B, DIM-100) may be substituted. All four of these tests are set for unbalanced input devices and all four sweep amplitude from 100 mV to 2 Volts, but balanced devices and different generator amplitude sweep ranges may be easily substituted.

31.3.6. Distortion Versus Frequency

Three of System One's distortion measurement methods may be usefully swept in frequency to obtain information about the device's linearity across portions of the audio spectrum. The fourth method, DIM, is designed principally for operation at specific frequencies, although DIM sweeps can provide some additional information with relatively sophisticated analysis techniques. THD+N, SMPTE, and CCIF tests are easily swept.

THD-FRQ.TST, SMPT-FRQ.TST, and CCIF-FRQ.TST are test files to measure distortion while sweeping the generator frequency or frequencies across useful ranges. THD-FRQ.TST sweeps a single sinewave across the complete 20 Hz-20kHz spectrum while measuring THD+N in an 80 kHz measurement bandwidth. SMPT-FRQ.TST sweeps the upper frequency of the two-tone test signal from 2.5 kHz to 20 kHz while maintaining the low frequency tone at 60 Hz. CCIF-FRQ.TST sweeps the two-tone pair from a center frequency of 4 kHz to 20 kHz while maintaining a 1 kHz spacing between the tones. These tests are all set for balanced input devices and a 0 dBu generator output amplitude, but may be easily changed to unbalanced output and any other generator amplitude desired.

31.3.7. Distortion at Constant Power Tests

DIST-PWR.TST is designed to graph the distortion (THD+N) across the frequency spectrum at the rated power output of an amplifier. It uses System One's REGULATION mode. At each frequency, it will adjust the generator output amplitude until it produces the output power specified on the REGULATION panel (50 Watts as the test is stored) from the amplifier, then will measure and graph the distortion. For power outputs different from 50 Watts, change the value on the REGULATION panel. For dummy load resistance values other than 4 Ohms, change the dBm/W REF value on the ANALYZER panel. Similarly, adjust analyzer bandwidth, frequency range extremes, number of steps, and distortion display graphic limits as required to best fit the particular amplifier under test. DIST-PWR.TST has generator amplitude limits of 5 Volts and 0.1 Volts set, which should handle most models of power amplifier. If the power amplifier under test requires a higher or lower input signal for rated power output, change the HI BOUND and LO BOUND values on the REGULATION panel accordingly.

PWR-BAND.TST is a power bandwidth test for a power amplifier. It uses REGULATION mode to adjust generator amplitude until the amplifier output signal distortion has approximately 0.1% distortion (THD+N). This will be a fairly critical adjustment with many amplifiers, since their distortion will be well below this value until clipping and well above 0.1% with very small generator amplitude increases above the clipping threshold. After arriving at the target distortion value, the test will measure and graph the amplifier output power. The test will sweep across the audio spectrum and plot the available power output at which the specified value of distortion occurs. Note that the THD+N TOLERANCE on the SWEEP SETTling panel has deliberately been set quite broad to improve operation with low-distortion amplifiers which clip abruptly. Amplifiers with a "softer" overload or clipping characteristic may be tested to more consistent distortion values by reducing the THD+N TOLERANCE value. Other values of distortion may be entered on

the REGULATION panel. As in DIST-PWR.TST above, adjust the HI BOUND and LO BOUND values for the generator if required.

31.3.8. Tape Recorder Non-Linearity

MOL (Maximum Output Level) is the most common non-linearity test applied to analog tape recorders. MOL is commonly measured as a distortion versus amplitude sweep at a midband frequency. MOL.TST is a generator amplitude sweep for three head tape recorders, using a SETTling DELAY of 200 milliseconds. MOL.TST sweeps the generator amplitude from 6 dBu to +24dBu at 400 Hz while measuring THD+N (total harmonic distortion plus noise). If third harmonic distortion only is desired, an FBP-xxxx filter may be ordered at the third harmonic of the desired fundamental tone and plugged into an option socket. MOL.TST may then be modified by selecting that option socket in addition to THD+N mode. If the tape recorder is operating properly, the 3% distortion level (normally defined as Maximum Operating Level) will be the same in THD+N or third harmonic mode, since tape distortion is almost purely third harmonic. MOL.TST is set for balanced input devices, but may be changed.

31.3.8.1. Distortion Versus Frequency of Tape Recorders

Though perhaps less common than MOL tests, it is useful to measure distortion across the audio frequency spectrum on tape recorders. The test TAPE-THD.TST is designed for a stereo three-head tape recorder. It sweeps the spectrum from 10 kHz to 20 Hz, measuring THD+N at 15 logarithmically-spaced frequencies. The test is set up for professional machines (balanced input with +4 dBu as normal recording level), but can be easily changed to unbalanced generator output and can run at any amplitude. The sweep does not extend above 10 kHz since harmonic distortion is not a meaningful measurement above one-third to one-half the upper band limit in band-limited systems such as tape recorders. SETTling DELAY should be set to the value determined for a particular recorder and tape speed as described above.

2HD-THD.TST is set up for use in distortion versus frequency testing of stereo two-head tape machines such as broadcast cartridge machines, videotape and videocassette machines, etc. It uses as a signal source the same tape recorded for frequency response testing by file 2HD-RCRD.TST as described earlier in this chapter. It could also use any pre-recorded reference tape which proceeds in steps from low to high frequency, if the duration of each step is approximately one to one and one half seconds. The frequency axis calibration extends to 20 kHz since 2HD-RCRD.TST will record to 20 kHz and most reference tapes extend to at least 18 kHz, but the actual harmonic distortion data will not be meaningful above approximately one-third the upper band limit of the tape machine being tested.

31.3.9. Compact Disc Player Non-Linearity

It is useful to measure compact disc player linearity in several fashions. THD+N may be measured across the audio spectrum with test signals furnished on all known test discs. Quantization distortion can be measured across the dynamic range of the CD system with signals furnished on some test discs. Most test discs also furnish one or two intermodulation distortion test signals which may be analyzed by System One.

31.3.9.1. CD Player THD+N Versus Frequency

The same increasing-frequency sets of tracks mentioned above for CD player frequency response testing can also be used to measure THD+N versus frequency. These tracks include tracks 4 through 16 on the Technics CD Test Disc Volume 1 (SH-CD001), tracks 46 through 55 on the Denon disc, tracks 2 through 13 on the Sony Test CD Type 3 (YEDS 7) test disc, and tracks 8 through 38 on the Japan Audio Society disc.

The test file CD-THD.TST is provided for use with any of these test discs. As with the CD frequency response test CDFREQ2.TST, the fastest test will result from manually advancing the CD player to the next trip each time the computer signifies ac-

quisition of the current track data with a “beep”. CD-THD.TST measures THD+N with a bandwidth of 22 kHz; other bandwidths may be selected.

It may be interesting to note that the rapid increase in “distortion” common at higher frequencies with most less-expensive CD players is not actually harmonic distortion, but the feed-through of a beat product between the CD player sampling clock frequency and the tones recorded on the disc. An oscilloscope or spectrum analyzer fed from System One’s “PROCESSED SIGNAL OUTPUT” connector (terminology on units below s/n 20300) or READING connector (terminology on units above s/n 20300) will show what the measured “distortion products” consist of. With a 20.00 kHz tone playing from the test disc, for example, the measured signal will often be found to consist of a clean, stable 24.100 kHz sinewave caused by the beat with the 44.100 kHz sample clock.

31.3.9.2. Quantization Distortion

Several test discs include a series of decreasing-amplitude tracks at a fixed frequency, usually one kHz or nearby. CDQUANTZ.TST is provided to measure the quantization distortion of a compact disc player with these tracks. The usable signals include tracks 22 through 33 on the Technics test disc SH-CD001 or tracks 14 through 22 on the Sony test disc YEDS 7. By converting CDQUANTZ.TST from STEREO to a single-channel test plotting DATA-1 only, it could be used with the Philips Test Sample 3 disc (410 055-2) tracks 7 (left channel) or track 11 (right channel).

CDQUANTZ.TST is set up with EXTERNAL LEVEL as SOURCE-1, expecting a decreasing-amplitude progression from 0 dBr to -90 dBr. The ANALYZER dBr REF is set to 2.000 Volts, which is a relatively standard value for output amplitude from a consumer compact disc player while playing a full-scale amplitude track. This dBr REF can be set to the exact value of the CD player under test by playing a test disc track with a 1 kHz maximum amplitude track and pressing the <F4> key before starting the series of test tracks for CDQUANTZ.TST.

To use CDQUANTZ.TST, cue the CD player to the first in the series of tracks described above, start the player, and press <F9>. Except for the Philips disc, each time the computer “beeps”, advance the player to the next track. The Philips disc has eight amplitudes recorded in sequence in each of the tracks mentioned above rather than the separate tracks of the Technics and Sony, so the player is merely started and allowed to run. CDQUANTZ.TST will graph the quantization distortion and noise (both stereo channels with the Sony or Technics discs) vertically, as a function of the output amplitude of the player (horizontally).

CDQUANTZ.TST is set with distortion expressed in absolute units (dBr, relative to the output of the CD player on a maximum-amplitude track) rather than units relative to the present output amplitude such as % or dB. This is to better demonstrate that quantization distortion is a constant-distortion-amplitude phenomenon relating to the least significant bit size of the digital system, rather than an analog phenomenon related to the present amplitude. The theoretical quantization distortion level in a 16-bit PCM system such as compact disc players is approximately -98 dBr. Practical high quality players approach the -94 dBr area.

The player output amplitude is expressed in dBr with reference to maximum output, as measured with the LEVEL voltmeter. The horizontal data plotting points at the -80 and -90 dBr levels can be expected to deviate somewhat from the theoretical values for three reasons. First, the D-to-A converter (and digital filters, if used) of the CD player will not be perfectly linear at these amplitudes. Errors of 1-4 dB are common.

Secondly, the signal at these levels is traversing only the few least bits of the CD player D-to-A converter and is thus highly distorted. The LEVEL voltmeter's RMS converter will respond to the total power in the signal, which is different from a pure sinewave at the same peak amplitude.

Thirdly, the LEVEL voltmeter is operating far below its specified quality range at these levels. The LEVEL voltmeter is specified down to 10 millivolts and is typically usable at these frequencies down to

one millivolt. On the -80 and -90 dBr tracks, it is being asked to measure signals of approximately 200 microvolts and 60 microvolts, respectively; it may therefore contribute one or two dB of error in addition to the nonlinearity and waveform problems.

Since the exact recorded amplitudes of these tracks are specified in the documentation of the test CD, the measured data is easy to correct. Use <Esc> to go to the menu, and Edit Data to view and modify the data. Press the <Ins> key to go from insert to overwrite mode. Replace any values in the first column of the data editor which deviate by more than a few tenths of a decibel with the exact values provided by the test CD manufacturer. Press <Esc> to move back to the menu and re-display the data with <F7> or save the test.

A value which may need to be changed for optimum testing with different models of CD players is SETTTLING DELAY on the SWEEP SETTTLING panel. SETTTLING DELAY in EXTERNAL sweeps is the length of time after settling of the swept external source (amplitude as read by the LEVEL voltmeter, in this case) before the system will attempt to start obtaining settled data (THD+N in this case). Various models of compact disc players have widely varying times required for them to move ahead to the next track and provide stable output signals from that track when advanced by their “next track” control buttons. SETTTLING DELAY must be set to the player's stabilization time as a minimum in order to prevent the test from attempting to measure and settle on the noise coming from the CD player while it is seeking from one track to the next. Fast-indexing CD players may permit reduction of the two second value stored in CDQUANTZ.TST for SETTTLING DELAY, and slow players may require that it be increased. This same SETTTLING DELAY will also be invoked when System One switches to channel B to measure the alternate track, since CDQUANTZ.TST is set up as a stereo test.

31.4. Phase Measurements

Electronic phase measurements at audio are normally either measurements of input-output phase shift through a device, or measurements of the inter-channel phase error of a stereo system. System One makes both types of measurements.

31.4.1. Input-Output Phase Measurements

The basic System One hardware compares phase of a signal at the A input to that at the B input. If the B input signal source is selected as GEN-MONITOR and the generator output configuration is selected as A&B, System One will measure the input-output phase shift of a device connected between the generator A output and the analyzer A input. Test file I-OPHASE.TST is set up for this configuration. In addition to phase, I-OPHASE.TST also measures the frequency response of the device under test. The test is set up for balanced devices with line-level inputs such as most equalizers, but may be converted to unbalanced devices with other input levels by changing the generator output configuration and amplitude. Graphic limits are set as typical for parametric and graphic equalizer testing, but may be adjusted as desired.

Certain types of signal processors have large amounts of phase shift at high frequencies. System One, unlike most other measurement systems, can plot this shift as a continuous function of frequency even when the phase shift is many thousands of degrees. With "deg" selected as the data display unit, System One will inspect each phase reading from the hardware and add or subtract the integral multiple of 360 degrees which will cause that reading to plot closest to the previous reading. I-OPHASE.TST operates in the "deg" display mode and devices with large phase shift can be plotted simply by changing the DATA-1 GRAPH TOP and BOTTOM values as desired. If "deg1" is selected, System One will plot on a +/-180 degree fixed scale with abrupt graphic transitions whenever the measured value exceeds either limit, rather than the con-

tinuous function. Similarly, "deg3" selects a fixed 0 to 360 degree scale instead of continuous data plotting.

31.4.2. Interchannel Phase Measurements

TAP-PHAS.TST is set up for interchannel phase testing of three-head stereo tape recorders, but can be easily speeded up for electronic devices simply by reducing the SETTling DELAY from 250 milliseconds to 30 milliseconds. The phase display sensitivity can be adjusted as desired by changing the DATA-1 GRAPH TOP and BOTTOM values after the test is run and the maximum excursions are known.

2HD-PHAS.TST is a test for measuring interchannel phase of two-head tape machines in playback mode, using either the test tape recorded with 2HDRCRD.TST as described earlier or a pre-recorded reference tape with spot frequencies in ascending order.

CDPHASE.TST is set up to measure interchannel phase of a CD player plus frequency response of the left channel. It is designed to operate with continuous analog sweeps (glide tones) such as track 65 of the Denon disk and track 41 of the Japan Audio Society disc. Load the test, go to panel mode, start the CD player, press <F4> to set the dBr REF value as soon as the 1 kHz reference signal appears, then press <F9> for the test. Uncompensated CD players with a single D-to-A converter multiplexed between the two channels will show phase shift (actually, time delay) increasing to about 82 degrees at 20 kHz if they are single sampling (44.1 kHz clock) units and about 41 degrees at 20 kHz if double oversampling (88.2 kHz clock). Units with two D-to-A converters or single-converter units with time delay compensation should show no significant phase shift even at 20 kHz.

31.4.3. Tape Recorder Azimuth Adjustments

Both reproduce head and record head azimuth adjustments of tape recorders can be best made with phase measurements, or a combination of phase and amplitude measurements. On a three-head tape machine, reproduce head azimuth must first be adjusted with use of a reference tape. Record head azimuth may then be adjusted to match the reproduce head.

Reproduce head azimuth adjustment is commonly done while playing a reference tape section with a relatively-high frequency tone such as 10 kHz. AZ-REPRO.TST is set up to be used in bargraph (<F2>) mode for reproduce head azimuth adjustment. In bargraph mode, AZ-REPRO.TST will display three measured values. The top bargraph is the playback amplitude from the left track of the recorder. DATA-1 GRAPH TOP and BOTTOM values may need to be modified to provide optimum bargraph display sensitivity for the peaking adjustment. The center bargraph is interchannel phase. The bottom bargraph is the measured frequency from the tape. Coarse azimuth adjustment can be done by first peaking for maximum amplitude on the top bargraph. Fine azimuth adjustment is then completed by adjusting for an average of zero degrees interchannel phase, though the instantaneous readings can be expected to jitter by tens of degrees on most analog tape machines at 10 kHz. Note that the fixed deg1 units are used for the center bargraph to prevent autoranging which would confuse the display. The purpose of the bottom bargraph is to alert the operator if the reference tape has played on past the 10 kHz section to another section which might be inappropriate for azimuth adjustments.

The test file 3HD-AZIM.TST is set up for easy adjustment of record head azimuth after the reproduce head has been properly aligned. 3HD-AZIM.TST is designed for use in the <Alt><F9> sweep-erase-repeat mode. This will provide a repeating five-frequency log-spaced sweep from 1 kHz to 15 kHz, plotting interchannel phase as a function of frequency. Alignment of the record head to match the already-aligned reproduce head is indicated when the data plots as a straight horizontal line across the 1 kHz-15 kHz frequency range. Mis-

alignment is indicated by a graph curving upwards or downwards as the frequency sweeps. Since phase is being measured at five frequencies across approximately four octaves, it is impossible to accidentally adjust for a phase zero at a high frequency which is actually 360 degrees off from proper alignment, as can be done with steady-tone single-frequency methods.



32. ANALYZER AND GENERATOR HARDWARE

32.1. Analyzer Block Diagram

Figure 32-1 is a simplified block diagram of the analyzer and generator with all options other than the DSP. The DSP hardware is described in the separate DSP User's Manual.

The analyzer diagram shown (serial number SYS1-20300 or higher), consists of the LVF Level and Frequency Measurement Module, the DIS Distortion Measurement Module, the PHA-LVF Dual Input and Phase Measurement option, the IMD-DIS analyzer option, and the Wow and Flutter analyzer option.

Assuming that the PHA-LVF module is present, there are identical input circuits for Channels A and B. The signal path is through the input attenuators and preamplifiers. At the output of the input signal conditioning block, each channel's signal is presented to the phase meter input. This same signal for each channel drives the INPUT MONITOR connector through a 6 dB attenuator. The INPUT MONITOR is intended for applications such as oscilloscope monitoring; the signal is ground-referenced, with an amplitude range between approximately 1.7 Volts peak-to-peak and 3.5 Volts peak-to-peak as the input amplitude varies and the autoranging circuit functions.

The phase meter measures phase by comparing the zero crossing times (average of both positive and negative zero crossings to eliminate errors due to non-symmetrical signals) at the B input with reference to the A input.

The input autoranging control circuits are peak sensitive in order to prevent overload of amplifier stages even with high crest factor signals. Autoranging is effected by switching both attenuation and amplification, and takes place in 6 dB steps from 160 Vrms down to 80 millivolts rms, which is the most

sensitive input range. Below 80 mV, the amplitudes of the INPUT MONITOR jack and all other internal signals drop in direct proportion.

Either A or B is selected to drive the principal (READING) voltmeter. With System One hardware below s/n SYS1-20300, this same selected signal always also drives the LEVEL voltmeter and the frequency counter. With hardware of serial SYS1-20300 or higher, the selected signal drives both LEVEL and RDNG voltmeters and the counter in all functions except 2-CHANNEL and CROSTALK. In those two functions, the selected channel drives the READING voltmeter while the alternate channel drives the LEVEL voltmeter and the frequency counter.

For selective frequency measurement of one portion of a complex signal or simply for increased frequency-measurement sensitivity, it is possible to connect the counter to the output of the BP/BR filter on units above serial number SYS1-20300. This connection will result while the RDNG meter is in either BANDPASS, BANDREJECT, or W+F modes if the BP/BR frequency is either swept (SOURCE-1 ANLR BP/BR) or the ANLR BP/BR frequency control on the ANALYZER panel is changed from AUTO to a fixed frequency .

If any of the standard low-pass filters (80 kHz, 30 kHz, or 22 kHz) are selected, another low pass filter will be inserted prior to the counter to improve its performance under noisy conditions. The frequency counter is a period-average measuring design, with the period reciprocal computed by the LVF microprocessor for display as frequency. Gate times, which determine the number of signal periods averaged, are selected by the reading rate control. The signal amplitude at the channel selection point is measured by the LEVEL voltmeter on the DIS board.

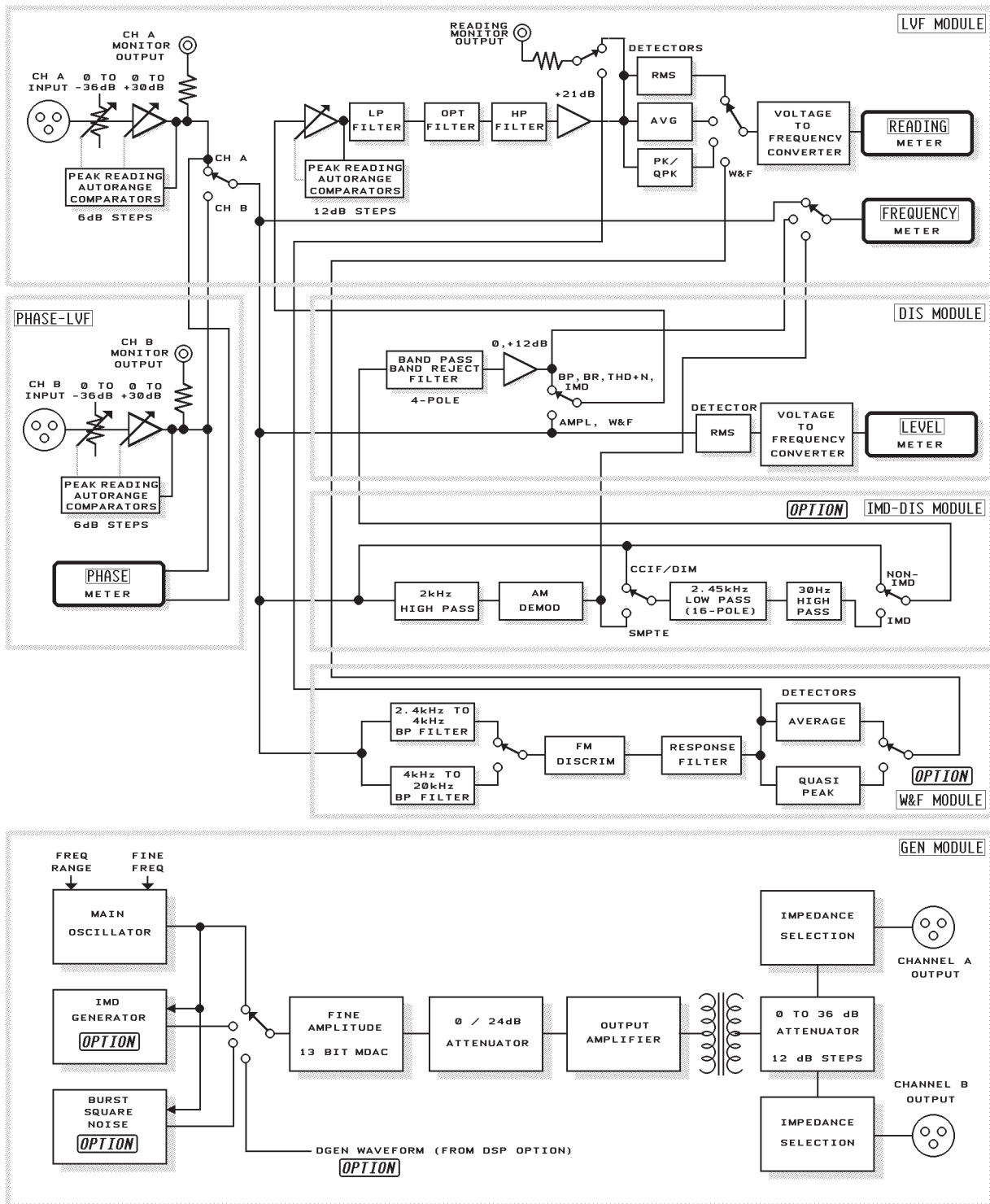

Figure 32-1 Analyzer and Generator Block Diagrams

If THD+N, BANDPASS, BANDREJECT, or CROSSTALK modes are selected, the signal is passed through the two-stage filter in the appropriate configuration. Filter gain is either 0 dB or 12 dB, depending on its output amplitude. In THD+N mode with relative units (% , dB, etc.), the computer calculates the ratio of distortion products (principal voltmeter) to original signal amplitude (LEVEL meter) and displays the result as READING. No set level or automatic gain control is thus needed. Useful THD+N measurements may be made with signal amplitudes of tens of microvolts if the BP/BR filter frequency is fixed at the signal fundamental frequency. If AMPLITUDE or W&F is selected, the signal is simply passed back to the LVF board without filtering or additional gain.

If the IMD-DIS option is present and selected in SMPTE mode, the signal flows through a 2 kHz high pass filter to remove the low frequency tone. It is then demodulated by an amplitude modulation detector and the output is processed by a low-pass filter to remove any residual high frequency tone. If the BP/BR filter selection on the ANALYZER panel is AUTO, the DIS filter is configured as a band reject filter and positioned to increase rejection of the high frequency tone. If the BP/BR filter is changed to a fixed frequency or swept by selecting LVF BPBR as SOURCE-1, the filter is configured as a bandpass and can select individual intermodulation products.

In CCIF and DIM IMD modes, the signal after input signal conditioning is fed to a 16-pole 2.45 kHz elliptical low pass filter. In CCIF mode, the DIS bandpass filter is cascaded with the output of the IMD-DIS board. This bandpass filter will be automatically tuned to the CCIF difference frequency, as measured by the frequency counter when in CCIF analysis mode. In DIM analysis mode, the output of the 2.4 kHz low-pass filter is not processed by the DIS bandpass filter if the ANALYZER panel selection for BP/BR is AUTO. If the selection is changed to a specific frequency or swept by choosing SOURCE-1 as LVF BPBR, the bandpass filter will further process the output of the IMD-DIS board.

An additional controllable gain stage following the DIS module signal return point is controlled by a second peak-sensitive autoranging control circuit. It is this autoranging function which can be overridden by changing the AUTO field near the top of the ANALYZER control panel to one of the fixed gain ranges. Selectable low pass filters, sockets for optional filters (plus the external filter connections with A-version hardware), and selectable high pass filters follow. A final amplification stage drives the measurement detectors. This same signal, through a 6 dB isolation pad, feeds the connector labeled PROCESSED SIGNAL OUT on units below s/n SYS1-20300 and READING in units above SYS1-20300. This connector, provided for oscilloscope or spectrum analyzer monitoring, shows the final ac signal which is presented to the detector inputs after all processing.

When the Wow and Flutter option is present and selected, the signal after conditioning is fed to either a 2.4 kHz-4.0 kHz bandpass for normal wow and flutter modes or to a 4 kHz-20 kHz bandpass filter for the "HB" (scrape flutter) modes. The output of the selected bandpass is fed to a frequency modulation discriminator. The discriminator output may be fed through a wow and flutter weighting filter or fed directly to a low-frequency-optimized detector on the W&F board. The dc output of this detector may then be selected instead of one of the ANALYZER detectors.

The dc output of the selected detector drives a voltage-to-frequency converter of approximately 100 kHz full scale at 2.5 Volts dc input. The v-to-f converter's pulse train output is fed to a frequency counter with selectable gate times of approximately 32 ms (32 readings/second), 64 ms (16 readings/sec), 130 ms (8 readings/sec), and 260 ms (4 readings/second). The counter full scale resolution ranges from approximately 3,150 counts at 32 readings/second to about 25,200 counts at 4 readings/second.

The autorange circuit control, detector v-to-f converter output frequency measurement, frequency counter, and phase meter are all managed by a 6805

microprocessor on the LVF Module, which also manages other low-level activity where fast response time is needed.

32.2. Generator Block Diagram

The generator block diagram is shown in the lower portion of Figure 32-1. The main oscillator is a state-variable design using two 13-bit MDACs (multiplying D/A converters) as variable resistors to control frequency over a 10:1 or 20:1 range. Range selection is by switched capacitors, with the four ranges being 10 Hz-204 Hz, 204 Hz-2.04 kHz, 2.04 kHz-20.4 kHz, and 20.4 kHz-204 kHz. In sinewave modes, this oscillator output is selected into the fine amplitude control circuitry whose variable element is another 13-bit MDAC. The signal is then passed through a switchable 0/24 dB gain stage and into the output power amplifier. The power amplifier output is transformer-coupled into a compensated resistive attenuator with a 36 dB range in 12 dB steps. Following this attenuator (assuming a two-channel output), the signal is resistively split into two paths with selectable build-out resistors establishing the specified source impedances. The AMPLITUDE value entered by the user into the GENERATOR panel will control the fine amplitude MDAC, 24 dB gain stage, and output attenuators in a manner transparent to the user in order to optimize output signal-to-noise ratio while providing better than 0.01 dB (or 1.27 microvolts, whichever is greater). If either output is OFF, the connector will be reverse-terminated in the selected output impedance.

32.2.1. Intermodulation Test Signal Generation Hardware

When the IMD generator option is present and an IMD waveform selected, the main oscillator signal is fed to the IMD-GEN module to be combined with a second signal generated within this module. In SMPTE (DIN) waveform mode, the IMD-GEN module generates a low-frequency sinewave at one of seven selectable frequencies and combines this with the main oscillator signal in either a 4:1 or 1:1 amplitude ratio, as selected. This complex signal is then fed to the fine amplitude MDAC.

In CCIF waveform mode, the same low-frequency sinewave generator with the same seven selectable frequencies feeds one input of an analog multiplier (balanced modulator). The main oscillator signal is the other input. The output of the multiplier is a DSSC (double sideband suppressed carrier) signal, which is fed to the fine amplitude MDAC. The main oscillator signal supplies the suppressed carrier, typically attenuated more than 50 dB. The two sidebands are spaced above and below the suppressed carrier by the frequency of the low-frequency oscillator on the IMD-GEN board. Thus, the spacing between the two sidebands is twice the frequency of the low-frequency oscillator and the software control panel is calibrated by that spacing value. To generate the typical 13 kHz/14 kHz CCIF test tone pair, for example, the main oscillator is set to 13.5 kHz and the IM-FREQ value is selected as 1 kHz. This selection actually produces a 500 Hz sine-wave from the low-frequency oscillator. The result is a calibrated-amplitude two-tone pair at 13 kHz and 14 kHz, with a suppressed “carrier” some 50 dB below the 13 kHz and 14 kHz tones.

In DIM (dynamic intermodulation or transient intermodulation) waveform, the IMD-GEN module generates a squarewave at 3.15 kHz (DIM-30 or DIM-100) or 2.96 kHz (DIM-B). The main oscillator frequency should be set by the user to 15 kHz for DIM-30 or DIM-100, or to 14 kHz for DIM-B. This main oscillator signal is combined with the squarewave at a level 12.04 dB below the peak amplitude of the squarewave and fed to the fine amplitude MDAC.

32.2.2. BUR Option Hardware

The BUR option adds sinewave burst, squarewave, and noise generation capabilities to the System One generator.

In sinewave burst modes, the sinewave signal is generated by the main oscillator. The BUR option provides synchronous switching at sinewave positive-going zero crossings between a unity-gain value and an attenuated value and feeds the fine amplitude

MDAC. Free-running burst, triggered, and gated modes are available as described in the BUR-GEN chapter of this manual.

Squarewaves are generated by a special circuit that optimizes symmetry for minimum even-harmonic content. The output of this generator is further low-pass filtered to control the risetime characteristics and limit energy content above 500 kHz to negligible levels.

In noise modes, random or pseudo-random white noise is digitally generated in the BUR-GEN module and fed to the fine amplitude MDAC. The PINK selection adds a 3 dB per octave "pinking" (high-frequency attenuation) filter to the path. In the BPASS and EQBPN modes, the output of the pinking filter is fed back into the main oscillator circuitry and passed through the main oscillator state-variable filter configured as a two-pole one-third octave bandpass filter. The output of that filter is then fed to the fine amplitude control. Thus, the FREQUENCY field on the GENERATOR panel controls the center frequency of this bandpass-filtered pink noise.

32.2.3. Auxiliary Generator Connectors

The GEN Generator Module has two auxiliary outputs available at BNC connectors on a separate panel which may be mounted on the front or rear of the enclosure.

SYNC is a ground-referenced squarewave suitable for driving LSTTL circuitry. In sinewave modes, the SYNC signal is at the generator frequency. In SMPTE IMD mode, the SYNC signal is at the low tone frequency. In CCIF IMD mode, SYNC is at one-half the spacing of the two-tone pair. In DIM IMD mode, SYNC is at the DIM squarewave frequency. In PSEUDO noise mode, a pulse at the pseudorandom cycle repetition rate (approximately 4/sec) appears at the SYNC connector. No signal is present in RANDOM noise modes. In SINE BURST, SINE TRIG, and SINE GATE modes, the SYNC signal follows the envelope of the output signal.

MONITOR is also ground-referenced. It is a fixed-amplitude (approximately 2.8 Volts peak-to-peak) version of the selected waveform. It will thus be a sinewave in SINE modes, the intermodulation test signal in IMD modes, a noise signal in noise modes, a burst signal in burst modes, etc. This signal is, however, picked off before the GENERATOR OUTPUT ON-OFF control and will thus be present even when the generator is turned off on the GENERATOR panel.

The panel also includes a BNC connector labeled TRIGGER/GATE input for control of the triggered and gated sine burst modes of the BUR-GEN module. See the BURST-SQUAREWAVE-NOISE generator for operational, timing, and logic level details.



33. S1.EXE ERROR REPORTING DESCRIPTIONS

System One software can report various errors. The following information is a brief discussion of the most likely causes, and corrections.

B

bad command

CAUSES : Attempting to enter data into a procedure, macro, comments, or data buffer, using the insert mode when there isn't sufficient memory remaining in the selected buffer to accept the data.

CORRECTIONS : Restart S1.EXE using the /B command line option to define the size of the destination buffer so that it is large enough to contain the required data.

NOTE : This error alternates with the "no more room for insertions" error.

Block too large for buffer and will be lost. Delete anyway? (y/n)

CAUSES :

1 : Attempting to block delete data with the F6 function key to the copy buffer when the amount of memory available in the selected procedure, macro, comment, or data buffer is insufficient to contain the data designated to be moved into the copy buffer.

2 : Attempting to block delete data with the Alt. F6 function key into the macro copy buffer when the amount of memory available in the selected procedure, macro, comment, or data buffer is insufficient to contain the data designated to be moved into the macro copy buffer.

NOTE : The size of the copy or macro copy buffer that the data is stored into when using the F6 or Alt. F6 function keys is based on the amount of memory left over in the selected procedure, macro, comment, or data buffer before removing the data.

CORRECTIONS :

1 : If the goal is to delete, not copy, type "y" for YES to delete the selected data.

2 : If the goal is to copy the block of text, restart S1.EXE using the /B command line option to define the size of the destination buffer so that it is large enough to contain the required data.

BURST INTERVAL MUST BE LARGER THAN ON-TIME

CAUSES : Attempting to set the BURST ON parameter to a value which exceeds the BURST INTERVAL.

CORRECTIONS : Increase the BURST INTERVAL to a value larger than the BURST ON value or decrease the BURST ON value to a value less than the BURST INTERVAL.

C

Cannot compute DATA-2 when HOR-AXIS is selected

CAUSES : An attempt was made to compute normalize, compute smooth, compute center, compute linearity, compute the wow & flutter 2-sigma value, or compute delta values from DATA-2 data when the sweep definitions panel secondary controls sweep measurement mode is set to HOR-AXIS.

CORRECTIONS : Don't select 2 for the DATA selection in the normalize, smooth, center, compute linearity, compute 2-sigma, or compute delta functions when the secondary controls sweep measurement mode is set to HOR-AXIS.

CANNOT EDIT PROCEDURE DURING RECORD OR PLAYBACK

CAUSES :

1 : The procedure that is being executed contains commands to edit the procedure that is currently being run.

2 : In the process of creating a procedure using the UTIL LEARN mode the EDIT & PROCEDURE commands are selected to edit the procedure currently in the procedure buffer.

CORRECTIONS : Break out the section of code to be dynamically altered into a sub-procedure. Then from the main procedure edit the sub procedure in the comments buffer using the EDIT & COMMENT commands from the command menu (CMD:). This will allow you to dynamically edit a test procedure.

CANNOT LOAD OR EDIT MACRO WHILE RUNNING MACRO — MACRO HALTED

CAUSES :

1 : An EDIT MACRO command was executed from within an executing macro.

2 : A LOAD MACRO command was executed from within an executing macro.

CORRECTIONS : Eliminate all instances where a macro edits or loads another macro.

CANNOT RUN SHELL — FILE SPECIFIED NOT EXECUTABLE

CAUSES : When using the command menu (CMD:) DOS or XDOS function, DOS has returned an error code designating that the specified file is not executable because its format does not match the DOS specification for an executable file.

CORRECTIONS : Verify that the file is an executable file and that the file name and path is entered correctly in the command menu (CMD:) DOS or XDOS function.

CANNOT RUN SHELL — FILE SPECIFIED NOT FOUND

CAUSES : When using the command menu (CMD:) DOS or XDOS function, DOS has returned an error code designating that the specified file was not located.

CORRECTIONS : Verify that the path and file name are correct.

CANNOT RUN SHELL — NOT ENOUGH MEMORY RESERVED (USE /Rx OPTION)

CAUSES : When using the command menu (CMD:) XDOS or DOS functions, DOS has returned an error code designating that sufficient memory is not available to temporarily exit to DOS without removing S1.EXE from memory.

CORRECTIONS : Force S1.EXE to reserve at least 45K of DOS memory before allocating the remaining memory to the internal buffers. This will guarantee that DOS has 45K of available memory to run executable programs. This is accomplished by starting S1 .EXE software with the following command line.

EXAMPLE : "S1 /R45"

NOTE : The 45k of available memory required to perform a DOS SHELL is based on requirements for DOS version 5.0.

CANNOT RUN SHELL — REASON UNKNOWN

CAUSES : When using the command menu (CMD:) XDOS or DOS functions, DOS has returned an error code designating that an undetermined error has occurred that prevents a DOS shell from being performed.

CORRECTIONS : Investigate and correct the cause of the abnormal exit condition from the executable program.

Cannot set this field in AUTO mode

CAUSES :

1 : An attempt was made to set the reading meter range field while the range mode field is set to AUTO.

2 : An attempt was made to set the channel 1 or 2 input range field while the range mode field is set to AUTO.

CORRECTIONS :

1 : Set the reading meter range units field to (* or dB), then set the range field to the desired range setting.

2 : Set the channel 1 or 2 input range units field to one of the available units, then set the channel 1 or 2 input range field to the desired range setting.

Ch A de-emphasis overload detected

NOTE : Error generated by the MLS DSP program.

CAUSES : In the MLS DSP program clipping of the DSP INPUT channel 1 de-emphasis (un-pinking) filter has occurred.

CORRECTIONS :

1 : Reduce the input level for DSP INPUT channel 1.

2 : Select the FLAT weighted MLS sequence from the MLS DSP panel right-hand WAVEFORM field.

NOTE : The un-pinking filter is used with pink weighted MLS sequences only.

Ch B de-emphasis overload detected

NOTE : Error generated by the MLS DSP program.

CAUSES : In the MLS DSP program clipping of the channel 2 de-emphasis (un-pinking) filter has occurred.

NOTE : The un-pinking filter is used with pink weighted MLS sequences only.

CORRECTIONS :

1 : Reduce the input level for DSP INPUT channel 2.

2 : Select the FLAT weighted MLS sequence from the MLS DSP panel right-hand WAVEFORM field.

COMMENTS FILE TOO LARGE TO LOAD

CAUSES : The default or designated edit comments buffer size is too small to hold the required information.

CORRECTIONS : Increase the size of the edit comment buffer to a value large enough to accommodate the largest ASCII file that is required to be loaded. As a rule set the edit comment buffer size to the file size of the largest file to be loaded as determined by the DOS directory command.

NOTE : The following example sets the comments buffer to 1000 characters.

EXAMPLE "S1 /Bn,n,n,n,1000,n".

COMMENTS TOO LARGE FOR BUFFER — TEXT AT END MAY BE LOST

CAUSES : The default or designated comments buffer size is too small to hold the comments contained within the test (*.TST), overlay (*.OVL), sweep (*.SWP), equalization (*.EQ), or limit (*.LIM) file that is being loaded.

CORRECTIONS : If the comments are important and the test is to be re-saved, increase the size of the edit comments buffer to a value large enough to accommodate the comments contained within the file

being loaded. If the test will not be saved or if the comments are not important, the warning message may be ignored.

NOTE : The following example sets the comments buffer to 1000 characters.

EXAMPLE "S1 /Bn,n,n,n,1000,n".

Conflict with Maximum amplitude

CAUSES :

1 : A value entered into the generator panel amplitude field manually or via a procedure is greater than the available generator maximum amplitude for the selected units, frequency, and output configuration.

2 : Attempting to increment or sweep the amplitude above the maximum amplitude value for the selected output configuration was made.

3 : Attempting to manually set the generator tone burst off amplitude to a level greater than 100%.

4 : Attempting to set the generator tone burst off amplitude, via the sweep definitions panel (TB-LVL), or procedurally, to a value greater than 100%.

CORRECTIONS :

1 : Enter a value into the generator amplitude field that is less than the generator maximum amplitude for the selected units, frequency, and output configuration.

2 : Verify that the sweep definitions generator amplitude parameter remains below the generator maximum amplitude for the selected units, frequency, and output configuration.

3 : Verify that the generator tone burst off amplitude remains below 100%.

4 : Verify that the sweep definitions generator tone burst off amplitude parameter remains below 100%.

Conflict with Maximum DC Volts

CAUSES : A value entered manually, in a sweep, or procedurally into the DCX-127 panel DC OUT 1&2 volts field is greater than maximum DC volts level.

CORRECTIONS : Check that the value entered manually, on the sweep definitions panel, or procedurally into the DCX-127 DC OUT 1&2 volts field is less than the DC volts maximum level of 10.5 Volts.

Conflict with Maximum frequency

CAUSES :

1 : Attempting to enter a value into the generator panel frequency field manually or procedurally that is above the maximum frequency value for the selected waveform.

2 : Attempting to sweep or increment the frequency to a value above the maximum frequency value for the selected waveform.

CORRECTIONS : Assure that the value entered into the generator frequency field or maximum value on the sweep definitions panel falls below the generator maximum frequency value for the selected waveform.

Conflict with Minimum amplitude

CAUSES :

1 : A value entered into the generator panel amplitude field manually, in a sweep, or procedurally is less than the minimum generator amplitude for the selected units, frequency, and output configuration.

2 : Attempting to set or decrement the generator amplitude below zero for the Vrms, Vp-p, and W units.

3 : Attempting to manually set the generator burst off amplitude to a level less than -80.17 dB.

4 : Attempting to set the generator tone burst off amplitude (TB-LVL), via the sweep definitions panel, to a level below -80.17 dB.

CORRECTIONS :

1 : Enter a value into the generator amplitude field that is greater than the generator minimum amplitude for the selected units, frequency, and output configuration.

2 : Verify that the sweep definitions generator amplitude parameter remains above the generator minimum amplitude for the selected units, frequency, and output configuration.

3 : Verify that the generator tone burst off amplitude remains above -80.17dB.

4 : Verify that the sweep definitions generator tone burst off amplitude parameter remains above -80.17dB.

Conflict with Minimum dBr reference

CAUSES : An attempt was made to set the generator or analyzer dBr reference field to a value of 1.0e-9 or below.

CORRECTIONS : Set the generator or analyzer dBr reference field to a reference value greater than 1.0e-9.

Conflict with Minimum DC Volts

CAUSES : A value entered manually, in a sweep, or procedurally into the DCX-127 panel DC OUT 1&2 volts field is less than minimum DC volts level.

CORRECTIONS : Check that the value entered manually, on the sweep definitions panel, or procedurally into the DCX-127 DC OUT 1&2 volts field is greater than the DC volts minimum level -10.5 Volts.

Conflict with Minimum frequency

CAUSES :

1 : Attempting to enter a value into the generator panel frequency field manually, via a procedure, during a sweep, or from a sweep table that is below the minimum frequency value for the selected waveform.

2 : Attempting to decrement the frequency to a value below the frequency minimum value for the selected waveform.

3 : An attached sweep table has a blank line in-between the header and the first data point.

CORRECTIONS :

1-2 : Enter a value into the generator frequency field or into the sweep definitions panel that falls above the generator minimum frequency value for the selected waveform.

3 : The most likely cause is that external processing was done to the sweep table file, and the header and data was not reconstructed correctly before it was loaded and saved as a sweep source file.

Conflict with Minimum reference R

CAUSES : An attempt was made to set the generator or analyzer dBm/W reference field to a value less than 0.1 ohms.

CORRECTIONS : Set the generator or analyzer dBm/W reference field to a load impedance value equal to or greater than 0.1 ohms.

D

DATA SAMPLES MUST BE <=6 TO CHANGE FROM AVG MODE

CAUSES : Attempting to set the sweep settling panel settling mode to EXPONENTIAL, FLAT or OFF while the data samples value is greater than 6.

CORRECTIONS : Set the data samples to a value less than or equal to 6, then change the settling mode to the desired selection.

DATA TOO LARGE FOR BUFFER — DATA AT END MAY BE LOST**CAUSES :**

1 : The default or designated data buffer size is too small to hold the data (# STEPS plus one) contained within the test (*.TST), overlay (*.OVL), sweep (*.SWP), equalization (*.EQ) or limit (*.LIM) file that is being loaded.

2 : The default or designated edit data buffer size is too small to hold the acquired or loaded data.

CORRECTION REQUIRED TO VIEW DATA WITH <F7>, PRINT, ETC. :

1 : Increase the size of the points data buffer to a value large enough to accommodate the data contained within the file being loaded.

EXAMPLE "S1 /B500,n,n,n,n".

CORRECTION REQUIRED IN ADDITION TO THE ABOVE IF YOU WISH TO EDIT THE DATA:

2 : Increase the size of the edit data buffer to a value large enough to accommodate the data. The data header consists of 60 characters and each measurement occupies 38 characters for DATA1 measurements and an additional 23 characters for DATA2 measurements. To edit data consisting of 50 DATA1 measurements the edit data buffer should be set to 1960 by using the following command line option when starting S1.EXE.

EXAMPLE "S1 /Bn,n,1960,n,n,n".

To edit data consisting of 50 DATA1 measurements and 50 DATA2 measurements the edit data buffer should be set to 3111 by using the following command line option when starting S1.EXE.

EXAMPLE "S1 /Bn,n,3111,n,n,n".

DIO option not present — A/D or DGEN are only valid input settings

NOTE : Error generated by FFTGEN, FFTSLIDE, MLS, FASTTEST, & FASTTRIG DSP programs. "DIO option" refers to digital input-output module which is part of System One Dual Domain (SYS-3nn)

CAUSES : Attempting to select a digital input with "System One + DSP" models (SYS-2nn).

CORRECTIONS : Select A/D or DGEN as the DSP input selection only.

DIO option not present — D/A is only valid output setting

NOTE : Error generated by FFTGEN, MLS, FASTTEST, & FASTTRIG DSP programs. "DIO option" refers to digital input-output module which is part of System One Dual Domain (SYS-3nn)

CAUSES : Attempting to select a digital source with "System One + DSP" models (SYS-2nn).

CORRECTIONS : Select D/A as the DSP output selection only.

DOS CANNOT RUN A SHELL (COMSPEC NOT FOUND IN THE ENVIRONMENT)

CAUSES : The computer operating system cannot locate the command interpreter (COMMAND.COM).

CORRECTIONS : Enter the text in the following example into your AUTOEXEC.BAT file and warm boot the computer (Ctrl/Alt/Delete) if a copy of COMMAND.COM is located in your (C:\DOS) directory.

EXAMPLE :

"SET COMSPEC=C:\DOS\COMMAND.COM"

DSP does not respond to RESET.

CAUSES :

1 : Interruption of the APIB bus communication.

2 : Software or hardware failure.

CORRECTIONS :

1 : Restart S1.EXE and the System One hardware after correcting any problems with the cable connecting the PC to System One.

2 : Report error to Audio Precision.

DSP HOST VECTOR NOT AVAILABLE

CAUSES :

1 : Interruption of the APIB bus communication.

2 : Interruption of power to System One.

3 : Incorrect DSP firmware for DSP programs versions 5.0 and higher.

NOTE : All DSP units shipped prior to January 30, 1990 must be re-programmed with the EE22.EXE program before the version 5.0 and higher DSP programs will function properly.

CORRECTIONS :

1 : Restart S1.EXE and the System One hardware after correcting any problems with the cable connecting the PC to System One.

2 : Use the commands UTIL RESTORE from the command menu (CMD:) to reset the System One hardware to the state defined by the currently loaded test.

3 : Run the EE22.EXE program specified in the DSP Program Technical Bulletin shipped October 1992.

DSP IS NOT RETURNING READINGS

CAUSES :

1 : Interruption of the APIB bus communication.

2 : Failure of DSP to update readings. Software or hardware failure.

CORRECTIONS :

1 : Restart S1.EXE and the System One hardware after correcting any problems with the cable connecting the PC to System One.

2 : Report error to Audio Precision.

DSP READING UNIT SELECTED MUST HAVE INPUT SOURCE FROM ANLR

CAUSES :

1 : FFTGEN.DSP, FFTSLIDE.DSP, MLS.DSP

1.1 : Attempting to set the AMPL-1 or AMPL-2 measurement units to one of the ratio selections (% , dB, PPM, X/Y) while a DSP channel 1 or 2 input source is set to GEN, DSP-A, DSP-B, or NONE.

2 : HARMONIC.DSP

2.1 : Attempting to set the FIL LVL 1 measurement unit to one of the ratio selections (% , dB) while a DSP channel 1 or 2 input source is set to GEN, DSP-A, DSP-B, or NONE.

CORRECTIONS :

1.1 : Select AMPL-1 and AMPL-2 measurement units that are not one of the ratio units (%FS, dBFS, V, dBm, dBu, dBV, dBr, W, or NONE) or select RDNG as the DSP channel 1 and 2 input source. Selecting ANLR-A or ANLR-B for the input sources will eliminate this error but will produce the "RATIO UNIT NOT SUPPORTED FOR DSP READINGS FROM ANLR-A or ANLR-B" error.

2.1 : Select a FIL LVL 1 measurement unit that is not one of the ratio units (Vrms, dBm, dBu, dBV, dBr, W, or NONE) or select RDNG as the DSP channel 1 and 2 input source. Selecting ANLR-A or ANLR-B for the input sources will eliminate this error but will produce the "RATIO UNIT NOT SUPPORTED FOR DSP READINGS FROM ANLR-A or ANLR-B" error.

DSP RECEIVE REGISTER NOT AVAILABLE

NOTE : Error generated by all DSP programs.

CAUSES :

1 : Interruption of the APIB bus communication.

2 : Interruption of power to System One.

3 : Incorrect DSP firmware for DSP programs versions 5.0 and higher.

NOTE : All DSP units shipped prior to January 30, 1990 must be re-programmed with the EE22.EXE program before the version 5.0 and higher DSP programs will function properly.

CORRECTIONS :

1 : Restart S1.EXE and the System One hardware after correcting any problems with the cable connecting the PC to System One.

2 : Use the commands UTIL RESTORE from the command menu (CMD:) to reset the System One hardware to the state defined by the currently loaded test.

3 : Run the EE22.EXE program specified in the DSP Program Technical Bulletin shipped October 1992.

DSP TRANSMIT REGISTER NOT AVAILABLE

NOTE : Error generated by all DSP programs.

CAUSES :

1 : Interruption of the APIB bus communication.

2 : Interruption of power to System One.

CORRECTIONS :

1 : Restart S1.EXE and the System One hardware after correcting any problems with the cable connecting the PC to System One.

2 : Use the commands UTIL RESTORE from the command menu (CMD:) to reset the System One hardware to the state defined by the currently loaded test.

DSP: Conflict with Maximum setting

NOTE : Error generated by all DSP programs.

CAUSES :**1 : BITTEST**

1.1 : Attempting to set, sweep, or increment the digital generator frequency (DGEN FREQ) to a value greater than 8.007996kHz at a 32kHz sample rate, 11.036kHz at 44.1kHz, 12.011kHz at a 48kHz via the panel interface, sweep definitions panel, or procedurally.

1.2 : Attempting to set, sweep, or increment the generator amplitude (AMPL) to a value greater than 100% FS (Full Scale) or 0 dBFS via the DSP panel interface, sweep definitions panel, or procedurally.

1.3 : Attempting to set the constant value (VALUE) to a decimal value greater than 7fffff HEX via the DSP panel interface, sweep definitions panel, or procedurally.

1.4 : Attempting to execute a SOURCE-1 sweep with the GENFRQ start or stop frequency set to values greater than one-half the sample rate, the GENAMP start or stop set to values greater than 100% FS or 0 dBFS, the TIME start or stop set to values greater than 341.6 mS.

2 : FFTGEN

2.1 : Attempting to set or increment the generator frequency (DGEN FREQ) to a value greater than 468.75Hz at a 1kHz sample rate, 3.753kHz at 8kHz, 15.01499kHz at 32kHz, 22.533kHz at 48kHz, or 20.69188kHz at 44.1kHz via the DSP panel interface, sweep definitions panel, or procedurally.

2.2 : Attempting to set or increment the generator amplitude (AMPL) to a value greater than 100% FS (Full Scale) or 0 dBFS via the DSP panel interface, sweep definitions panel, or procedurally.

2.3 : Attempting to execute a SOURCE-2 sweep with the digital generator (GENFRQ) start (GRAPH TOP) or stop (BOTTOM) frequencies set to values greater than one-half the sample rate, the digital generator amplitude (GENAMP) start or stop amplitudes set to values greater than 100% FS or 0 dBFS.

2.4 : Attempting to make a frequency domain display (SOURCE-1 DSP FREQ) “sweep” with the frequency start or stop frequencies set to values greater than one-half the sample rate, or a time domain display with the TIME start or stop set to a values greater than 16.39 seconds at a 1kHz sample rate, 2.05 seconds at 8kHz, 512.5 mS at 32kHz, 341.6 mS at 48kHz, 85.41 mS at 192kHz, 371.8 mS at 44.1kHz, and 92.97 mS at a 176.4kHz sample rate via the sweep definitions panel or procedurally.

3 : FFTSLIDE

3.1 : Attempting to set, sweep, or increment the start time (FFT START) to a value greater than 30.75 sec at a 1kHz sample rate, 3.844 sec at 8kHz, .9609 at 32kHz, 640.6 mS at 48kHz, 160.2 mS at 192kHz, 697.3 mS at 44.1kHz, and 174.3 mS at 176.4kHz via the DSP panel interface, sweep definitions panel, or procedurally.

3.2 : Attempting to set, sweep, or increment the amount of data acquired before trigger (PRE-TRIG) to a positive value via the DSP panel interface, sweep definitions panel, or procedurally. All values for this field should be negative.

3.3 : Attempting to execute a SOURCE-2 sweep when the STRT or PRET start (GRAPH TOP) or stop (BOTTOM) times are set to values greater than those specified in sections 3.1 or 3.2 for this error.

3.4 : Attempting to make a frequency domain display (SOURCE-1 DSP FREQ) “sweep” with the FREQ start or stop set to values greater than one-half the sample rate, or a time domain display with the TIME start or stop value set to values greater

than 30.75 sec at a 1kHz sample rate, 3.844 sec at 8kHz, .9609 at 32kHz, 640.6 mS at 48kHz, 160.2 mS at 192kHz, 697.3 mS at 44.1kHz, and 174.3 mS at 176.4kHz via the sweep definitions panel or procedurally.

4 : GENANLR

4.1 : Attempting to set or sweep the generator frequency (DGEN FREQ) to a value greater than 15.01499kHz at a 32kHz sample rate, 22.522kHz at 48kHz, and 20.69188kHz at 44.1kHz via the DSP panel interface, sweep definitions panel, or procedurally.

4.2 : Attempting to set or sweep the generator amplitude (AMPL) to a value greater than 100% FS (Full Scale) or 0 dBFS via the DSP panel interface, sweep definitions panel, or procedurally.

4.3 : Attempting to set or sweep the filter frequency (FILT FREQ) to a value greater than 14.62647kHz at a 32kHz sample rate, 21.7897kHz at 48kHz, and 20.01901kHz at 44.1kHz via the DSP panel interface, sweep definitions panel, or procedurally.

4.4 : Attempting to execute a SOURCE-1 sweep with the GENFRQ start or stop frequency values greater than specified in section 4.1 for this error, the GENAMP start or stop values greater than 100% FS (Full Scale) or 0 dBFS, the FILFRQ start or stop values greater than specified in section 4.3 for this error.

5 : HARMONIC

5.1 : Attempting to set or sweep the bandpass filter frequency to a value greater than 21.76799kHz at a 48kHz sample rate, and 87.07198kHz at 192kHz via the DSP panel interface, sweep definitions panel, or procedurally.

5.2 : Attempting to set or sweep the bandpass filter harmonic multiplier (HARMONIC) to a value greater than 9 via the DSP panel interface, sweep definitions panel, or procedurally.

5.3 : Attempting to set or sweep the bandpass filter frequency offset (F OFFSET) to a value greater than 21.79046kHz at a 48kHz sample rate, and 87.16185kHz at 192kHz via the DSP panel interface, sweep definitions panel, or procedurally.

5.4 : Attempting to execute a SOURCE-1 sweep with the FREQ start or stop frequency values greater than specified in section 5.1 for this error, the HARM start or stop values greater than 9, the F_OFF start or stop values greater than specified in section 5.3 for this error.

6 : FASTTEST

6.1 : Attempting to set the frequency resolution (FREQ RES) for W&F to a value greater than 5.00489 or increment the setting to a value greater than 5 via the DSP panel interface, sweep definitions panel, or procedurally.

6.2 : Attempting to set or sweep the generator amplitude (DGEN AMPL) to a value greater than 100% FS (Full Scale) or 0 dBFS via the DSP panel interface, sweep definitions panel, or procedurally.

6.3 : Attempting to execute a SOURCE-2 sweep with the frequency resolution (FREQRS) start (GRAPH TOP) or stop (BOTTOM) percentage set greater than 5%, the digital generator amplitude (GENAMP) start or stop set to values greater than 100% FS (Full Scale) or 0 dBFS.

6.4 : Attempting to execute a SOURCE-1 sweep with the FREQ start or stop set to values greater than one-half the sample rate, the TIME start or stop values greater than the acquisition period (TRANSFORM length/RATE) via the sweep definitions panel or procedurally.

7 : FASTTRIG

7.1 : Attempting to set the frequency resolution (FREQ RES) for W&F to a value greater than 5.00489 or sweep the setting to a value greater than 5 via the DSP panel interface, sweep definitions panel, or procedurally.

7.2 : Attempting to set or sweep the digital generator amplitude (DGEN AMPL) to a value greater than 100% FS (Full Scale) or 0 dBFS via the DSP panel interface, sweep definitions panel, or procedurally.

7.3 : Attempting to execute a SOURCE-2 sweep with the frequency resolution FREQRS start (GRAPH TOP) or stop (BOTTOM) percentage set greater than 5%, the GENAMP start or stop set to values greater than 100% FS (Full Scale) or 0 dBFS.

7.4 : Attempting to execute a SOURCE-1 sweep with the FREQ start or stop set to values greater than one-half the sample rate, the TIME start or stop values greater than two times the generator waveform period ((generator waveform sample length/RATE)* 2) via the panel interface or procedurally.

8 : MLS

8.1 : Attempting to set or increment the time zero reference (REF TIME) used to compute FFT phase to a value greater than 1.025 sec at a 32kHz sample rate, 682.7 mS at a 48kHz sample rate, and 743.0 mS at a 44.1kHz sample rate via the DSP panel interface or procedurally.

8.2 : Attempting to set or increment the digital generator amplitude (AMPL) to a value greater than 100% FS (Full Scale) or 0 dBFS via the DSP panel interface or procedurally.

8.3 : Attempting to execute a SOURCE-2 sweep with the REFTIM start (GRAPH TOP) or stop (BOTTOM) percentage set greater than 3%, the GENAMP start or stop set to values greater than 100% FS (Full Scale) or 0 dBFS.

8.4 : Attempting to execute a SOURCE-1 sweep with the FREQ start or stop set to values greater than one-half the sample rate, the TIME start or stop value is set to values greater than 1.025 seconds at 32kHz, 683.3 mS at 48kHz, and 743.7 mS at 44.1kHz for full memory.

CORRECTIONS :

1-8 : Enter a value into the appropriate field that is less than the maximum value for the selected units and sample rate as designated in the preceding sections for this error.

DSP: Conflict with Minimum setting

CAUSES :

1 : BITTEST

1.1 : Attempting to set or sweep the generator frequency (DGEN FREQ) to a value less than 5.722046mHz via the DSP panel interface, sweep definitions panel, or procedurally.

1.2 : Attempting to set or sweep the generator amplitude (AMPL) to a value less than 0% FS (Full Scale) or -999.99 dBFS via the DSP panel interface, sweep definitions panel, or procedurally.

1.3 : Attempting to set or sweep the constant (VALUE) value to a value less than -8388608 via the DSP panel interface, sweep definitions panel, or procedurally.

1.4 : Attempting to execute a SOURCE-1 sweep with the generator frequency (GENFRQ) start or stop values set less than specified in section 1.1 for this error, the generator amplitude (GENAMP) start or stop values set less than specified in section 1.2 for this error, the constant (VALUE) start or stop values set less than specified in section 1.3 for this error, the TIME start or stop values set to less than zero.

2 : FFTGEN

2.1 : Attempting to set or sweep the digital generator frequency (DGEN FREQ) to a value less than zero hertz via the panel interface, sweep definitions panel, or procedurally.

2.2 : Attempting to set or sweep the generator amplitude (AMPL) to a value less than 0% FS (Full Scale) or -999.99 dBFS via the DSP panel interface, sweep definitions panel, or procedurally.

2.3 : Attempting to execute a SOURCE-2 sweep with the generator frequency (GENFRQ) start or stop frequency values set less than specified in section 2.1 for this error, the generator amplitude (GENAMP) start or stop values set less than specified in section 2.2 for this error.

2.4 : Attempting to execute a SOURCE-1 sweep with the FREQ start or stop values with a negative value, the TIME start or stop to less than at -16.4 sec at 1kHz, -2.05 sec at 8kHz, -512.5 mS at 32kHz, -341.6 mS at 48kHz, -85.41 mS at 192kHz, -371.1 mS at 44.1kHz, -92.97 mS at 176.4kHz.

3 : FFTSLIDE

3.1 : Attempting to set or sweep the start time (FFT START) to less than -38.75 sec at a 1kHz sample rate, -3.844 sec at 8kHz, -.9609 at 32kHz, -640.6 mS at 48kHz, -160.2 mS at 192kHz, -97.3 mS at 44.1kHz, and -174.3 mS at 176.4kHz via the panel interface, sweep definitions panel, or procedurally.

3.2 : Attempting to set or “sweep” the amount of data acquired before trigger (PRE-TRIG) to less than -8.389 sec at a 1kHz sample rate, -1.049 sec at 8kHz, -262.1 sec at 32kHz, -174.8 sec at 48kHz, -43.96 sec at 192kHz, -190.2 sec at 44.1kHz, and -47.55 sec at 176.4kHz via the panel interface, sweep definitions panel, or procedurally.

3.3 : Attempting to execute a SOURCE-2 sweep with the FFT start time (STRT) start or stop times set less than specified in section 3.1 for this error, the pre-trigger (PRET) start or stop times set less than specified in section 3.2 for this error

3.4 : Attempting to make a frequency domain display (SOURCE-1 DSP FREQ) “sweep” with the FREQ start or stop values with a negative value, or a time domain display with the TIME start or stop to less than at -16.4 sec at 1kHz sample rate, -2.05 sec at 8kHz, -512.5 mS at 32kHz, -341.6 mS at 48kHz, -85.41 mS at 192kHz, -371.1 mS at 44.1kHz, -92.97 mS at 176.4kHz.

4 : GENANLR

4.1 : Attempting to set or sweep the generator frequency (DGEN FREQ) to a value less than 3.334045Hz at a 32kHz sample rate, 5.001068Hz at 48kHz, and 4.594731Hz at 44.1kHz via the DSP panel interface, sweep definitions panel, or procedurally.

4.2 : Attempting to set or sweep the generator amplitude (AMPL) to a value less than 0% FS (Full Scale) or -999.99 dBFS via the DSP panel interface, sweep definitions panel, or procedurally.

4.3 : Attempting to set or sweep the filter frequency (FILT FREQ) to a value less than 13.33427Hz at a 32kHz sample rate, 20.00141Hz at 48kHz, and 18.3763Hz at 44.1kHz via the DSP panel interface, sweep definitions panel, or procedurally.

4.4 : Attempting to execute a SOURCE-1 sweep with the generator frequency (GENFRQ) start or stop frequency values set less than specified in section 4.1 for this error, the generator amplitude (GENAMP) start or stop values set less than specified in section 4.2 for this error, the filter frequency (FILFRQ) start or stop values set less than specified in section 4.3 for this error.

5 : HARMONIC

5.1 : Attempting to set or sweep the bandpass filter frequency to a value less than 19.99855Hz at a 48kHz sample rate, and 79.9942Hz at 192kHz via the DSP panel interface, sweep definitions panel, or procedurally.

5.2 : Attempting to set or sweep the bandpass filter harmonic multiplier to a value less than 1 via the DSP panel interface, sweep definitions panel, or procedurally.

5.3 : Attempting to set or sweep the bandpass filter frequency offset (F OFFSET) to a value less than -21.7687kHz at a 48kHz sample rate, and -87.0748kHz at 192kHz via the DSP panel interface, sweep definitions panel, or procedurally.

5.4 : Attempting to execute a SOURCE-1 sweep with the FREQ (frequency) start or stop values set less than specified in section 5.1 for this error, the harmonic (HARM) start or stop values set less than specified in section 5.2 for this error, the frequency offset (F_OFF) start or stop values set less than specified in section 5.3 for this error.

6 : FASTEST

6.1 : Attempting to set or sweep the frequency resolution (FREQ RES) for W&F to a value less than 0 via the DSP panel interface, sweep definitions panel, or procedurally.

6.2 : Attempting to set or sweep the digital generator amplitude (DGEN AMPL) to a value less than 0% FS (Full Scale) or -999.99 dBFS via the DSP panel interface, sweep definitions panel, or procedurally.

6.3 : Attempting to execute a SOURCE-2 sweep with the frequency resolution for W&F (FREQRS) start or stop percentage values set less than specified in section 6.1 for this error, the digital generator amplitude GENAMP start or stop values set less than specified in section 6.2 for this error.

6.4 : Attempting to make frequency domain display (SOURCE-1 DSP FREQ) "sweep" with the FREQ start or stop values set to a negative value, or to make a time domain display with the TIME start or stop to set less than -2.05 sec at 8kHz, -512.5 mS at 32kHz, -341.6 mS at 48kHz, -371.1 mS at 44.1kHz.

7 : FASTEST

7.1 : Attempting to set or sweep the frequency resolution (FREQ RES) for W&F to a value less than 0 via the DSP panel interface, sweep definitions panel, or procedurally.

7.2 : Attempting to set or sweep the generator amplitude (DGEN AMPL) to a value less than 0% FS (Full Scale) or -999.99 dBFS via the DSP panel interface, sweep definitions panel, or procedurally.

7.3 : Attempting to execute a SOURCE-2 sweep with the frequency resolution for W&F (FREQRS) start or stop percentage values set less than specified in section 7.1 for this error or the generator amplitude (GENAMP) start or stop values set less than specified in section 7.2 for this error.

7.4 : Attempting to make a frequency domain display (SOURCE-1 DSP FREQ) with the FREQ start or stop values set to a negative value, or a time domain display with the TIME start or stop values set less than -512.5 mS at 32kHz, -341.6 mS at 48kHz, -371.1 mS at 44.1kHz.

8 : MLS

8.1 : Attempting to set or sweep the time zero reference (REF TIME) for FFT phase to a value less than -5.12 mS at a 32kHz sample rate, -3.413 mS at a 48kHz sample rate, and -3.715 mS at 44.1kHz via the DSP panel interface, sweep definitions panel, or procedurally.

8.2 : Attempting to set or sweep the generator amplitude (GEN AMPL) to a value less than 0% FS (Full Scale) via the DSP panel interface, sweep definitions panel, or procedurally.

8.3 : Attempting to execute a SOURCE-2 sweep with the reference time (REFTIM) start or stop values set less than specified in section 8.1 for this error, the generator amplitude (GENAMP) start or stop values set less than specified in section 8.2 for this error.

8.4 : Attempting to make a frequency domain display (SOURCE-1 DSP FREQ) with the FREQ start or stop values with a negative value, or a time domain display with the TIME start or stop to less than -5.125 mS at 32kHz sample rate, -3.416 mS at 48kHz, -3.718 mS at 44.1kHz.

CORRECTIONS :

1-8 : Enter a value into the appropriate field that is greater than the minimum value for the selected units and sample rate as designated in the preceding sections for this error.

E

EDITOR CANNOT READ DATA -1 UNITS

CAUSES : Attempting to load a data file where the header (units values in the first line) for the DATA-1 units has been corrupted.

CORRECTIONS : The most likely cause is that external processing was done to the data file and the DATA -1 units in the header was not reconstructed correctly.

EDITOR CANNOT READ DATA -2 UNITS

CAUSES : Attempting to load a data file where the header (units values in the first line) for the DATA-2 units has been corrupted.

CORRECTIONS : The most likely cause is that external processing was done to the data file and the DATA -2 units in the header was not reconstructed correctly.

EDITOR CANNOT READ HORIZONTAL UNITS

CAUSES : Attempting to load a data file where the header (units values in the first line) for the horizontal units has been corrupted.

CORRECTIONS : The most likely cause is that external processing was done to the data file and the horizontal units in the header was not reconstructed correctly.

ENTERED VALUES NOT UNDERSTOOD — OPERATION ABORTED

CAUSES :

1 : A value entered into one of the parameters for the UTIL OUT command is not understood.

2 : A value entered into one of the parameters for the UTIL WAIT command is not understood.

CORRECTIONS :

1 : The value for the first parameter must either be a decimal number that designates the address of a port located in the PC or a character (A, B, C) designating a port on the DCX-127. The second parameter value must be a decimal number.

2 : All parameter values must be decimal values.

ERROR: At least one input channel must be enabled in order to acquire

NOTE : Error generated by FFTGEN, FFTSLIDE, MLS, FASTTEST, & FASTTRIG DSP programs.

CAUSES : Attempting to perform an acquisition (F9) with both input selections set to NONE.

CORRECTIONS : Set one of the DSP inputs to a selection other than NONE.

ERROR: Ch1 & Ch2 generator waveforms not of equal length

NOTE : Error generated by FASTTRIG DSP program.

CAUSES : An attempt to load different record length waveforms into the DSP generator 1G and 2G buffers.

CORRECTIONS : Load both generator buffers 1G and 2G with the same length waveforms.

ERROR: DSP program does not support EXTERN sweeps

NOTE : Error generated by FFTGEN, FFTSLIDE, MLS, FASTTEST, & FASTTRIG DSP programs.

CAUSES : Caused by attempting an EXTERN sweep utilizing any of the FFT based DSP programs such as FFTGEN, FFTSLIDE, MLS, FASTEST, or FASTTRIG

CORRECTIONS : Select from any of the following DSP programs that do support external sweeps BITTEST, GENANLR, or HARMONIC.

ERROR: Excessive tones in waveform for proper operation

NOTE : Error generated by FASTTRIG DSP program.

CAUSES : Attempting to execute a test after loading a waveform into the DSP generator buffers that contains more than 128 tones.

CORRECTIONS : Disable generator waveform & frequency correction warnings by setting the MEASURE right hand field to OFF on the FASTTRIG DSP panel or reduce the number of tones in the generated waveform.

ERROR: Frequency resolution setting conflicts with requested frequency

NOTE : Error generated by FASTTRIG DSP program.

CAUSES : An attempt to return an FFT frequency magnitude or phase reading for a frequency that is within the frequency resolution (FREQ RES) percentage of one half the sample rate.

CORRECTIONS :

1 : Disable generator waveform & frequency correction warnings by setting the MEASURE right hand field to OFF on the FASTTRIG DSP panel.

2 : Restrict the measurement bandwidth to less than one half the sample rate minus the percentage specified in the FREQ RES field.

ERROR: TRIG & Freq Correction modes require Ch1 & Ch2 generator waveforms

NOTE : Error generated by FASTTRIG DSP program.

CAUSES : Attempting an acquisition before both generator buffers are loaded.

CORRECTIONS : Load both generator waveform buffers 1G & 2G before attempting an acquisition.

ERROR: Waveform file is not an MLS impulse response

NOTE : Error generated by the MLS DSP program.

CAUSES : Attempting to load a waveform other than an MLS impulse response record.

CORRECTIONS : Load only MLS impulse response waveform data when using the MLS DSP program.

ERROR: Waveform file is not of proper type for selected buffer

NOTE : Error generated by the FFTGEN, FFTSLIDE, MLS, FASTTEST, or FASTTRIG DSP programs.

CAUSES :

1 : Attempting to transfer a generator waveform into DSP acquisition memory.

2 : Attempting to load an MLS impulse record.

CORRECTIONS :

1 : Transfer only data saved via the SAVE WAVEFORM (1, 2, or 1T, 2T) commands into acquisition memory.

ERROR: Waveform load not of valid length

NOTE : Error generated by the FASTTRIG DSP program.

CAUSES : Attempting to load a generator waveform file that is not of the proper length.

CORRECTIONS : Load a waveform that consists of one of the following record lengths (256, 512, 1024, 2048, 4096, 8192).

ERROR LOADING DSP PROGRAM

CAUSES : Corrupted DSP file.

CORRECTIONS : Replace the corrupted DSP file from the distribution diskettes.

Error loading sub-procedure

CAUSES : The default or designated edit procedure buffer size is too small to hold the required sub-procedure.

CORRECTIONS : Increase the size of the edit procedure buffer to a value large enough to accommodate the largest procedure file that is required to be loaded. As a rule set the edit procedure buffer size to the file size of the largest procedure file to be loaded as determined by the DOS directory command.

EXAMPLE "S1 /Bn,n,n,5000,n,n".

F

F8, ALT- F8, and ALT-F9 disabled

CAUSES : An F8, Alt. F8, or Alt. F9 was executed after the /8 command line option was used to start the S1.EXE software. This option eliminates the buffer required to store image information.

CORRECTIONS : Remove the /8 command line option when starting System One software.

FATAL ERROR: DSP PROGRAM REQUIRES DIO or MEM OPTION

NOTE : Error generated by the FASTTRIG DSP program. "DIO OPTION" refers to the digital input-output module which is part of System One Dual Domain (SYS-3nn). This module contains additional memory in addition to digital inputs and outputs.

CAUSES : Attempting to load the FASTTRIG DSP program when System One does not contain sufficient memory to run the program correctly.

CORRECTIONS :

1 : If digital input or output is not needed, install the System One retrofit MEM-DSP memory option. This will add additional memory required by the FASTTRIG DSP program.

NOTE : MEM-DSP memory is not upward compatible in later conversions to System One Dual Domain (SYS-3nn) units.

2 : If digital input or output is valuable, install the System One retrofit DSP-250 to add digital input/output and memory which upgrades System One + DSP (SYS-2nn) units to System One Dual Domain (SYS-3nn) units.

FILE APLAST\$.GDL COULD NOT BE WRITTEN

CAUSES : An attempt to save the temporary file APLAST\$.GDL was made when the maximum number of files allowed in the floppy disk root directory has been reached.

CORRECTIONS : Change directories or delete unused files from the current floppy disk root directory.

FILE CANNOT BE READ — DISK ERROR — OPERATION ABORTED

CAUSES :

1 : Attempting to load a corrupt graphics (.GDL) file.

2 : Attempting to load a waveform (.WAV) file with a corrupt header.

CORRECTIONS : Resave or recreate the file and try again.

FILE CANNOT BE WRITTEN — DISK ERROR OR FULL — SAVE ABORTED

CAUSES : The storage medium doesn't have room to save the required information.

CORRECTIONS : Delete all unnecessary files on the selected medium to free additional storage memory.

FILE NOT FOUND

CAUSES : The file specified was not located in the current directory or in the directory explicitly specified in the LOAD, SAVE, APPEND, EDIT, DOS, or NAMES functions.

CORRECTIONS : Copy the required file into the current directory or explicitly define the path when selecting the file to load.

FILE SPECIFIED NOT A VALID DATA FILE — LOAD ABORTED

CAUSES : Attempting to load a data file with a length of zero (0).

CORRECTIONS : The most likely cause is that insufficient disk space was available when the file was saved or copied, creating a file with a record length of zero.

FILE SPECIFIED NOT A VALID TEST FILE — LOAD ABORTED

CAUSES : When loading a test, overlay, sweep source, EQ, or limit file, the format doesn't conform to the S1.EXE test file format.

CORRECTIONS : Select a valid S1.EXE test, overlay, sweep, EQ, or limit file.

FILE SPECIFIED WRONG VERSION OF DSP FILE — LOAD ABORTED

CAUSES :

1 : Attempting to load a file other than a DSP program file.

2 : Attempting to load a DSP program that requires a specific version of the S1.EXE program with an earlier version.

CORRECTIONS :

1 : Select or use only DSP programs supplied by Audio Precision with the .DSP extension. To date all DSP programs released are compatible with the 2.10A release of S1.EXE.

2 : Select the appropriate version DSP programs to be run with the selected S1.EXE software or visa-versa.

NOTE : Refer to the technical bulletins issued with each update.

FILE WRITE ACCESS DENIED — DIRECTORY FULL OR WRITE PROTECTED

CAUSES : The selected file cannot be written to a storage medium because the file attribute is set to READ ONLY, the storage medium does not have room to store the file, or the disk is write protected.

CORRECTIONS : Clear the READ ONLY file attribute using the DOS ATTRIB command, create room for the desired file, or remove the write protection from the storage medium.

FREQRS may only be a sweep source-2 selection

NOTE : Error generated by the FASTTEST and FASTTRIG DSP programs.

CAUSES : Attempting to select the frequency resolution (FREQRS) as a sweep SOURCE-1 stimulus.

CORRECTIONS : Select frequency resolution (FREQRS) as a sweep SOURCE-2 parameter only.

G

GENAMP may only be a sweep source-2 selection

NOTE : Error generated by the FFTGEN, MLS, FASTTEST and FASTTRIG DSP programs.

CAUSES : Attempting to set the generator amplitude (GENAMP) parameter as the sweep SOURCE-1 selection on the sweep definitions panel.

CORRECTIONS : Select generator amplitude (GENAMP) as a sweep SOURCE-2 parameter only.

GENFREQ may only be a sweep source-2 selection

NOTE : Error generated by the FFTGEN DSP program.

CAUSES : Caused by trying to select GENFREQ as sweep SOURCE-1.

CORRECTIONS : Select generator frequency (GENFREQ) as a sweep SOURCE-2 parameter only.

Generator waveform frequencies too close for triggering or frequency correction

NOTE : Error generated by the FASTTRIG DSP program.

CAUSES : An attempt to execute a test with a DSP generator waveform loaded that has tones that violate the minimum frequency spacing of six bins (about 35 Hz with maximum resolution signal).

CORRECTIONS :

1 : Change to a waveform which conforms to the minimum spacing criteria.

2 : Disable generator waveform & frequency correction warnings by setting the MEASURE right hand field to OFF on the FASTTRIG DSP panel.

GOTO CANNOT FIND TARGET LABEL

CAUSES : The procedure currently being run can't find the label designated by the GOTO command.

CORRECTIONS : Check to see that the label exists in the same procedure as the GOTO statement and that the characters in the label are the same as designated by the GOTO statement.

H

Horizontal minimum cannot = maximum

EXPLANATION : On the sweep definitions panel there are three major groups of controls. For the purpose of error reporting the third group known as SOURCE-1 is identified as the horizontal controls.

CAUSES : An attempt was made to execute a test where the sweep definitions horizontal start and stop values are equal.

CORRECTIONS : Select different start and stop values for the sweep definitions panel horizontal values.

I

INVALID ACCESS CODE

CAUSES : System One has displayed an error reported by DOS.

CORRECTIONS : The error is located within the computer operating system and is most likely hardware related.

INTERNAL ERROR

CAUSES : Failure to detect valid panel settings when loading a test, overlay, sweep source, EQ, or limit file.

CORRECTIONS : Delete the corrupted file.

Invalid or missing numeric input

CAUSES : Failure to detect valid panel settings. Software or hardware failure.

CORRECTIONS : Report error to Audio Precision.

INVALID SELECTION

CAUSES : The panel interface is not returning the correct variables. Software or hardware failure.

CORRECTIONS : Report error to Audio Precision.

M

MACRO FILE TOO LARGE TOO LOAD

CAUSES : The default or designated edit macro buffer size is too small to hold the required information.

CORRECTIONS : Increase the size of the edit macro buffer to a value large enough to accommodate the largest macro file that is required to be loaded. As a rule set the edit macro buffer size to the file size of the largest macro file to be loaded as determined by the DOS directory command.

EXAMPLE "S1 /Bn,n,n,n,n,1000".

MISSING ']' IN PROCEDURE

CAUSES : A procedure has terminated without executing the same number of IF closing brackets as opening brackets.

CORRECTIONS : Debug your procedure so that a closing bracket is encountered for each opening bracket.

MUST USE /C1 OR /C2 OPTION TO ENABLE THIS FUNCTION

CAUSES :

1 : Selection of the RUN REMOTE or RUN SLAVE command menu (CMD:) commands when the /C1 or /C2 command line option was not used when starting S1.EXE.

2 : Setting a panel for remote operation without using the /C1 or /C2 command line options when starting S1.EXE.

CORRECTIONS : Restart S1.EXE using the /C1 or /C2 command line option.

EXAMPLE :

"S1 /C1" for COM port #1

"S1 /C2" for COM port #2

MUST USE /G OPTION TO ENABLE THIS FUNCTION

CAUSES : The SAVE GRAPHICS command menu (CMD:) function has been selected without using the /G command line option to enable this function.

CORRECTIONS : Restart System One S1.EXE software using the /G option.

EXAMPLE : "S1 /G"

FILE NAME = MUST USE 'SAVE OVERLAY' BECAUSE OF PUNCHED-OUT FIELDS

CAUSES : An attempt was made to save a set of set-up panels with punched-out fields as a standard test file (.TST) using the SAVE & TEST commands from the command (CMD:) menu.

CORRECTIONS :

1 : Save the set-up panels as an overlay (.OVL) using the SAVE & OVERLAY commands from the command menu (CMD:).

2 : Restore all punched out fields with the <ALT> <R> while the panels are displayed, before saving as a test file (.TST).

N

Negative Number encountered while Logging data

CAUSES : A negative value was encountered while converting values to obtain a LOG display. The value was converted to -999.99.

CORRECTIONS : The most likely cause is that external processing was done to a data file and the DATA -1 or DATA -2 data was not reconstructed correctly.

Need at least 2 data points between HIGH and LOW values.

CAUSES : Attempting to execute the COMPUTE LINEARITY commands when the number of data points between the second (HIGH) and third (LOW) parameters is less than two. Two data points are required to establish a straight line to be used as a reference for the linearity computation.

CORRECTIONS : Define the HIGH and LOW parameters so that at least two SOURCE-1 measurement points are made between the values.

NO DSP PROGRAM LOADED OR THIS SAMPLING RATE NOT SUPPORTED

CAUSES :

1 : Attempting to load waveform data into the DSP without having a DSP program loaded.

2 : Attempting to load waveform data into the DSP that is of a sample rate not supported by the DSP program currently loaded.

CORRECTIONS :

1 : Load the appropriate DSP program for the selected waveform data.

2 : Load the appropriate DSP program for the selected waveform sample rate.

NO MEASUREMENT SELECTED FOR DATA -1

CAUSES : On the SWEEP DEFINITIONS panel the DATA-1 measurement is set to NONE.

CORRECTIONS : Select a DATA-1 measurement other than NONE.

NO MORE FILE HANDLES AVAILABLE

CAUSES : Attempting to open more files than are permitted as defined in the CONFIG.SYS "FILES = X" parameter.

CORRECTIONS : Increase the number of files allowed by increasing the value for the "FILES = X" parameter in the CONFIG.SYS file.

no more room for insertions

CAUSES : Attempting to enter data into a procedure, macro, comments, or data buffer, using the insert mode when there isn't sufficient memory remaining in the selected buffer to accept the data.

CORRECTIONS : Restart S1.EXE using the /B command line option to define the size of the destination buffer so that it is large enough to contain the required data.

Number too large for field in use

CAUSES : The entered value is larger than the selected field is capable of displaying.

CORRECTIONS : Enter a value that can be displayed in the selected field.

P

PATH NOT FOUND (OR DRIVE NOT READY)

CAUSES :

1 : Attempting to access a non-existent drive.

2 : The drive door for the selected disk is open.

CORRECTIONS : Select a valid drive and make sure the drive door is closed.

PRET may only be a sweep source-2 selection

CAUSES :

1 : An attempt to select PRET (Pre-Trigger) as sweep SOURCE-1 for the FFTSLIDE DSP program.

CORRECTIONS :

1 : Select Pre-trigger as a sweep SOURCE-2 parameter only.

Primary minimum cannot = maximum

EXPLANATION : On the sweep definitions panel there are three major groups of controls. For the purpose of error reporting the first group known as DATA-1 is identified as the primary controls.

CAUSES : An attempt was made to execute a test where the sweep definitions primary start and stop values are equal.

CORRECTIONS : Select different start and stop values for the sweep definitions panel primary values.

PROCEDURE BUFFER IS EMPTY OR HAS WRONG VERSION HEADER

CAUSES :

1 : Attempting to execute a procedure when the procedure buffer is empty.

2 : Data residing in the procedure buffer doesn't contain the correct version header for the version of S1.EXE that is running.

CORRECTIONS :

1 : Load a procedure into the procedure buffer using the LOAD & PROCEDURE menu selections from the command menu (CMD:).

2 : Edit the first line of the procedure residing in the procedure buffer to reflect the version header for the version of S1.EXE being used. This can be done using the EDIT & PROCEDURE menu selections from the command menu (CMD:). The following example is for version 2.10A S1.EXE software.

EXAMPLE : "PROCEDUREv2.10"

PROCEDURE FILE TOO LARGE TO LOAD

CAUSES : The default or designated edit procedure buffer size is too small to hold the required procedure.

CORRECTIONS : Increase the size of the edit procedure buffer to a value large enough to accommodate the largest procedure file that is required to be loaded. As a rule set the edit procedure buffer size to the file size of the largest procedure file to be loaded as determined by the DOS directory command.

EXAMPLE "S1 /Bn,n,n,5000,n,n".

R

RATIO UNIT NOT SUPPORTED FOR DSP READINGS FROM ANLR-A or ANLR-B

1 : FFTGEN, FFTSLIDE, MLS

1.1 : Attempting to set the AMPL-1 or AMPL-2 measurement units to one of the ratio selections (% , dB, PPM, X/Y) while the DSP channel 1 or 2 input source is set to ANLR-A or ANLR-B.

2 : HARMONIC

2.1 : Attempting to set the FIL LVL 1 measurement units to one of the ratio selections (% , dB) while the DSP channel 1 or 2 input source is set to ANLR-A or ANLR-B.

CORRECTIONS :

1.1 : Select AMPL-1 and AMPL-2 measurement units that is not one of the ratio units (%FS, dBFS, V, dBm, dBu, dBV, dBr, W, or NONE) or select RDNG as the DSP channel 1 and 2 input sources.

2.1 : Select FIL LVL 1 measurement units that is not one of the ratio units (Vrms, dBm, dBu, dBV, dBr, W, or NONE) or select RDNG as the DSP channel 1 and 2 input sources.

READ ERROR ON SECOND CHANNEL

CAUSES : An attempt was made to load a single-record waveform file (containing only data for one channel) with the "1G,2G", "1T,2T", or "1,2" commands which expect a two-record waveform file.

EXAMPLE : "LOAD WAVEFORM filename <Enter>1T,2T<Enter>"

CORRECTIONS : Load the waveform data into the first channel then repeat the process for the second channel.

EXAMPLE : "LOAD WAVEFORM filename <Enter> 1T <Enter>LOAD WAVEFORM <Enter>2T <Enter>"

REFTIM may only be a sweep source-2 selection

NOTE : Error generated by the MLS DSP program.

CAUSES : Attempting to set the REFTIM (Reference Time) parameter as the sweep SOURCE-1 selection on the sweep definitions panel.

CORRECTIONS : Select REFTIM (Reference Time) as a sweep SOURCE-2 parameter only.

REMOTE DUS FAILURE - CHECK COM LINE OR TRY RESTORE

CAUSES :

1 : An interruption in the communication link between the computer and the "S" version System One during measurement settling.

2 : An interruption of an "S" version System One via the escape key during measurement settling.

CORRECTIONS :

1 : Reseat all connections and run UTIL RESTORE.

2 : Run the required test again allowing time for the test to complete before pressing escape.

REMOTE SETTING FAILURE - CHECK COM LINE OR TRY RESTORE

CAUSES :

1 : An interruption in the communication link between the master and slave computers.

2 : An interruption in the communication link between the computer and the "S" version System One.

3 : When starting S1.EXE software for the slave computer the proper /C1 or /C2 command line option was not used to designate which communication port to use to communicate with the master computer.

4 : When starting S1.EXE software for the slave computer the /S command line option or the RUN REMOTE command from the command menu was not used to configure the software for remote operation before communication was attempted by the master computer.

5 : When starting S1.EXE software on a laptop computer the proper /C1 or /C2 command line option was not used to designate which communication port to use to communicate with the System One hardware.

CORRECTIONS :

1 : Reseat all connections and run UTIL RESTORE.

2 : Check that a NULL MODEM cable is being used for "S" version System Ones.

3 : Check that the proper /C1 or /C2 command line options have been used with any remote operation configuration for the slave computer.

4 : Check that the /S command line option has been used or that the RUN SLAVE commands have been executed from the slave unit software to establish remote operation.

5 : Check that the proper /C1 or /C2 command line options have been used with any remote operation configuration for the master computer. An example configuration would be using a laptop computer with no slots available for a PCI card to control System One .

RUN EXIT has no Procedure to return to.

CAUSES : A sub-procedure has been loaded and run directly rather than being called from a main procedure, or the main procedure is executing a RUN EXIT before calling a sub-procedure, or the RUN EXIT menu selections have been selected from the command menu (CMD:).

CORRECTIONS : Correct any procedural flow control conditions that could result in calling the RUN EXIT commands before the RUN CALL commands are used to call and run a sub-procedure. Do not load and run sub-procedures directly from the command menu, or ignore the warning message if you choose to run sub-procedures by themselves.

S

SAVED IMAGE NOT COMPATIBLE WITH GRAPHICS MODE

CAUSES : A recall graphics F8 has been attempted but the sweep display mode defined on the sweep definitions panel DISPLAY field is not the same mode (MONO-GRAPH vs COLOR-GRAPH) as the graphics image stored using Alt-F8.

CORRECTIONS : Change the sweep display mode on the sweep definitions panel to the same mode used when the graphics data was stored.

Secondary minimum cannot = maximum

EXPLANATION : On the sweep definitions panel there are three major groups of controls. For the purpose of error reporting the second group known as DATA-2 SOURCE-2, HOR-AXIS, or STEREO is identified as the secondary controls.

CAUSES : An attempt was made to execute a test where the sweep definitions secondary start and stop values are equal.

CORRECTIONS : Select different start and stop values for the sweep definitions panel secondary values.

SETTLING MODE MUST BE AVG TO SET SAMPLES >6

CAUSES : Attempting to set the sweep settling panel data samples to a value greater than 6 while the settling mode was set to EXPONENTIAL, FLAT, or OFF.

CORRECTIONS : Set the settling mode to average (AVG) then enter any number up to 999.

SHELL PROGRAM RETURNS WITH NON-ZERO ERROR LEVEL

CAUSES : An executable program run from the command menu (CMD:) DOS function reported an abnormal exit condition at its termination.

CORRECTIONS : Investigate and correct the cause of the abnormal exit condition from the executable program.

Stepping not functional on this field

CAUSES : An attempt was made to increment or decrement the dBm/W impedance reference field at the bottom of the generator or analyzer panels.

CORRECTIONS : Incrementing or decrementing the dBm/W impedance reference field at the bottom of the generator or analyzer panels is not allowed.

STRING FORMAT NOT CORRECT

CAUSES : Attempting to enter an invalid character into the AES-EBU transmit status bytes.

CORRECTIONS : Enter only HEX values 00 through FF with a space between each value.

EXAMPLE : "04 00 00 ..."

STRT may only be a sweep source-2 selection

NOTE : Error generated by the FFTSLIDE DSP program.

CAUSES : Caused by trying to select STRT as sweep SOURCE-1.

CORRECTIONS : Select STRT (Start Time) as a sweep SOURCE-2 parameter only.

SUB-PROCEDURES NESTED TOO DEEP

CAUSES :

1 : An attempt to nest sub-procedures beyond 15 times.

2 : A procedure has called and then incorrectly exited (RUN EXIT command not used) from 16 sub-procedures.

CORRECTIONS :

1 : Don't nest sub-procedures beyond 15 times.

2 : Correct any procedural flow problems that can cause the procedure to exit without using the RUN EXIT command (CMD:)

SWITCHER CHANNEL NUMBER IS BEYOND VALID RANGE OF 0-192

CAUSES : A value entered manually, in a sweep, or by procedural control into the switcher panel channel selection field is greater than the maximum value of 192.

CORRECTIONS : Check that the value entered manually, on the sweep definitions panel, or by procedural control into the switcher panel channel selection field is less than the maximum allowable value of 192.

T

Text area is full, cannot copy from buffer!

CAUSES : Attempting to insert data located in the copy buffer into a procedure, macro, comments, or data buffer, using F5 or Alt. F5, when there isn't sufficient memory remaining in the destination buffer to accept the data in the copy buffer.

CORRECTIONS : Restart S1.EXE using the /B command line option to define the size of the destination buffer so that it is large enough to contain the required data.

Timeout

CAUSES : A timeout occurred when using the Ctrl-F3 regulation technique and the panels are displayed.

CORRECTIONS : Increase the TIMEOUT value on the SWEEP SETTling panel.

Too many digits, backspace and try u,m,k

CAUSES : When editing a numeric panel field the number of characters entered exceeds 18.

CORRECTIONS : Enter less than 18 characters to define the numeric entry.

NOTE : The u,m,k contained in the error message stands for micro, mili, and kilo respectively.

U

Use a positive stepsize only

CAUSES : Attempting to input a negative value into the AMPSTEP or FREQSTEP fields at the bottom of the generator panel.

CORRECTIONS : Enter a positive value into the AMPSTEP or FREQSTEP fields of the generator panel.

V

VALUE NOT UNDERSTOOD OR NOT FOUND IN DATA

CAUSES : The second value entered into the parameters of the COMPUTE NORMALIZE command is not understood.

CORRECTIONS : The value for the second parameter must be a decimal number that designates a value along the horizontal axis which is to be set to the target value after normalization.

W

Warning: Change panel to match new units

CAUSES : When loading or appending data the units in the .DAT file do not match the units designated on the sweep definitions panel.

CORRECTIONS : Set the units in the sweep definitions panel to match the units designated by the file to be appended or loaded. You may use the LOAD COMMENTS and EDIT COMMENTS feature (type *.DAT after LOAD COMMENTS in order to see the names of .DAT files in the directory) to view the .DAT file to see what units it contains.

Warning: Ch1 generator waveform should be loaded before ch2

NOTE : Error generated by the FASTTRIG .DSP program.

CAUSES : Attempting to load the channel 2 generator buffer (2G) before the channel 1 generator buffer (1G) has been loaded.

CORRECTIONS : Always load the DSP channel 1 generator buffer first.

Warning: Ch 1 time frame not set — must do a TIME sweep before FREQ sweeps

NOTE : Error generated by the MLS DSP program.

CAUSES : Caused by attempting to perform a frequency sweep (SOURCE-1 DSP FREQ) without having first done a time sweep (SOURCE-1 DSP TIME) with DSP INPUT channel 1 turned on.

CORRECTIONS : DSP input channel 1 must have a signal source selected and a time sweep conducted to define the portion of the impulse response to transform into a frequency response.

Warning: Ch1 & Ch2 time frames not set - must do a TIME sweep before FREQ sweeps

NOTE : Error generated by the MLS DSP program.

CAUSES : Caused by attempting to perform a frequency sweep (SOURCE-1 DSP FREQ) without having first done a time sweep (SOURCE-1 DSP TIME) with either channel turned on.

CORRECTIONS : One of the DSP input channels must have a signal source selected and a time sweep conducted to define the portion of the impulse response to transform into a frequency response.

Warning: Ch 2 time frame not set — must do a TIME sweep before FREQ sweeps

NOTE : Error generated by the MLS DSP program.

CAUSES : Caused by attempting to perform a frequency sweep (SOURCE-1 DSP FREQ) without having first done a time sweep (SOURCE-1 DSP TIME) with DSP INPUT channel 2 turned on.

CORRECTIONS : DSP input channel 2 must have a signal source selected and a time sweep conducted to define the portion of the impulse response to transform into a frequency response.

Warning: Frequency correction out of range

NOTE : Error generated by the FASTTRIG DSP program.

CAUSES :

1 : Attempting to provide frequency correction on signals that are beyond 3% of the fundamental frequency(s).

2 : If distortion is extreme, the frequency correction algorithm may erroneously select one of the distortion products as the fundamental and provide correction based on that frequency.

CORRECTIONS :

1 : Minimize speed error by e.g. adjusting pitch controls on a tape reproducer, adjusting generator frequency within 3% of the desired frequency(s) (waveform frequency loaded into the DSP generator).

2 : Correct any problems that cause distortion of this magnitude.

Warning: Generator waveform(s) must be loaded before acquiring

NOTE : Error generated by the FASTTRIG DSP program.

CAUSES : Attempting to acquire data <F9> without the FASTEST generator loaded.

CORRECTIONS : Load generator waveforms 1G and 2G before doing an acquisition.

Warning: Not enough tones in waveform for reliable triggering

NOTE : Error generated by the FASTTRIG DSP program.

CAUSES : Too few sinewave tones in the middle and upper frequency bands (typically 300 Hz to 10 kHz).

CORRECTIONS : Use a waveform with sufficient tones in the middle and upper frequency bands.

Warning: Waveform load overrun — file is longer than selected buffer

NOTE : Error generated by FFTGEN, FFTSLIDE, MLS, FASTTEST, & FASTTRIG DSP programs.

CAUSES : The record length specified in the waveform file header is longer than the length of the selected destination buffer.

CORRECTIONS :

1 : Change the destination buffer size e.g. select the appropriate transform length for the selected transform waveform.

2 : In a System One + DSP (SYS-2nn), install System One retrofit MEM-DSP memory option. This will add additional memory that will allow you to load generator and acquire waveforms created for or acquired with a full memory system.

NOTE : MEM-DSP memory is not upward compatible and can not be used if a later conversion is made to System One Dual Domain.

Install the System One retrofit DSP-250 to add input/output and memory, upgrading the SYS-2nn to SYS-3nn (System One Dual Domain).

Warning: Waveform load underrun — file is shorter than selected buffer

NOTE : Error generated by FFTGEN, FFTSLIDE, MLS, FASTTEST, & FASTTRIG DSP programs.

CAUSES :

1 : FFTGEN

1.1 : Attempting to load a waveform into the generator buffer (1G or 2G) that is of a record length shorter than 8192 (8k) points.

1.2 : Attempting to load a waveform into the acquisition buffer (1 or 2) that is of a record length shorter than 16384 points for full memory or 4086 points with standard memory.

1.3 : Attempting to load a waveform into the transform buffer (1T or 2T) that has a different record length than is selected, as defined by the FFT input data length (TRANSFORM) field.

2 : FFTSLIDE

2.1 : Attempting to load a waveform into the acquisition buffer (1 or 2) that is of a record length shorter than 30720 points for full memory or 8192 points with standard memory.

2.2 : Attempting to load a waveform into the transform buffer (1T or 2T) that has a different record length than is selected, as defined by the FFT input data length (TRANSFORM) field.

3 : MLS

3.1 : The record length for the specified impulse response waveform file header is shorter than the required length of the acquisition buffer.

NOTE : This can only happen if an attempt is made to load an impulse that was saved on a System One with standard memory into a system with full memory.

4 : FASTTEST

4.1 : Attempting to load a waveform into the generator buffer (1G or 2G) that is of a record length shorter than 8192 (8k) points for full memory and 2048 (2k) for standard memory.

4.3 : Attempting to load a waveform into the acquisition (1 or 2) or transform (1T or 2T) buffer that has a different record length than is selected, as defined by the FFT input data length (TRANSFORM) field.

5 : FASTTRIG

5.1 : Attempting to load a generator waveform (1G, 2G) with a record length other than 256, 512, 1024, 2048, 4096, or 8192 points.

5.3 : Attempting to load a waveform into the acquisition (1 or 2) or transform (1T or 2T) buffer that is not twice the record length of the waveform loaded into the generator buffer (1G and 2G)

CORRECTIONS :

1 : FFTGEN

1.1 : Load only 8192 point waveforms into the generator buffers for full memory (System One Dual Domain and System One + DSP with MEM option), and 2048 point waveforms for standard memory (System One + DSP without MEM option).

1.2 : Load only 16384 point waveforms into the acquisition buffers for full memory and 8192 point waveforms for standard memory.

1.3 : Adjust the transform input data length (TRANSFORM) to the record length used when the waveform was saved.

2 : FFTSLIDE

2.1 : Load only 30720 point waveforms into the acquisition buffers for full memory and 8192 point waveforms for standard memory.

2.2 : Adjust the transform input data length (TRANSFORM) to the record length used when the waveform was saved.

3 : MLS

3.1 : Load an impulse response that was acquired with the same memory configuration as System One currently contains.

4 : FASTTEST

4.1 : Load only 8192 point waveforms into the generator buffers for full memory and 2048 point waveforms for standard memory.

4.2 : Adjust the transform input data length (TRANSFORM) to the record length used when the waveform was saved.

5 : FASTTRIG

5.1 : 3 : When creating arbitrary waveforms always create a source data file consisting of 256, 512, 1024, 2048, 4096, or 8192 HEX data points in the .WAA file.

5.2 : Load waveforms that are twice the record length of the currently loaded generator record length.

WAVEFORM BUFFER SPECIFICATION NOT UNDERSTOOD

CAUSES :

1 : A value entered into one of the parameters designating the storage location for a waveform loaded via the LOAD WAVEFORM command is not understood.

CORRECTIONS : Enter only the following values (0, 1, 2, 1T, 2T, 1G, 2G) as the LOAD WAVEFORM parameter specifications.

WAVEFORM TRANSFER NOT SUPPORTED BY THIS DSP PROGRAM, OR DSP NOT AVAILABLE

CAUSES :

1 : Attempting to load or save waveform data to or from GENANLR.DSP or the HARMONIC.DSP programs.

2 : Attempting to load a waveform into the generator buffers for the FFTSLIDE or MLS DSP programs.

3 : Attempting to load a waveform into the transform buffers for the MLS DSP program.

4 : Attempting to load waveform data with a communication fault or the DSP does not exist.

CORRECTIONS :

1 : Waveform data is not applicable to the GENANLR.DSP or HARMONIC.DSP real time programs.

2 : Waveform data can't be loaded into the generator buffers for the FFTSLIDE or MLS DSP programs.

3 : Waveform data can't be loaded into the transform buffers for the MLS DSP program.

4 : Restart S1.EXE and the System One hardware after correcting any problems with the cable connecting the PC to System One.

**WRONG NUMBER OF ARGUMENTS FOR
FUNCTION**

CAUSES : A non-numeric value was entered for the delay time for the UTIL DELAY command.

CORRECTIONS : Enter a decimal value into the UTIL DELAY parameter.

34. FURNISHED DISK FILE DESCRIPTIONS

Software for non-DSP versions of System One is furnished on four diskettes. DSP versions include additional software on several more diskettes as described in the DSP User's Manual. The four diskettes furnished with standard System One are the S1.EXE diskette, Tests and Procedures diskette, Utilities & Equalization diskette, and Performance Checks diskette. This chapter lists the files furnished on the first three of these diskettes, along with a brief description of each file. The Performance Check files are not described here since they are all called by performance check procedures, run automatically with the proper limit and sweep files attached, and should not be changed in any way.

34.1. S1.EXE version: 2.10 Diskette

S1.EXE System One executable program.

@6064.ADF Supplied for the MICRO-CH option only. File used by PS/2 Microchannel Bus reference diskette to configure the computer for System One operation.

34.2. Test and Procedures Diskette

15-CRSTK.TST Test file for worst-case crosstalk versus frequency, tracks 10-24 of 24-track recorder operating at 30 inches per second, 0 VU. Nested sweep with frequency as SOURCE-1, SWR-122 switcher channel as SOURCE-2.

15-FREQ.TST Test file for frequency response, tracks 10-24 of 24-track recorder operating at 30 inches per second, 0 VU. Nested sweep with amplitude as SOURCE-1, SWR-122 switcher channel as SOURCE-2.

15-GAPSC.TST Test file for Gap Scatter across tracks 10-24 (switcher channels 1-15) of 24-track tape recorder. Measurement plots phase difference at 10 kHz of each track versus track 12 (switcher channel 3), near tape center.

15-TRACK.PRO Procedure to test the frequency response 15-FREQ.TST, distortion versus amplitude 15T-MOL3.TST, worst-case crosstalk versus frequency 15-CRSTK.TST, and gap scatter 15-GAPSC.TST of a multi-track tape recorder. Sub-procedure for SELECT.PRO procedure.

15T-MOL3.TST Test file for Maximum Output Level (MOL), tracks 10-24 of 24-track recorder operating at 30 inches per second, 0 VU. Nested sweep with amplitude as SOURCE-1, SWR-122 switcher channel as SOURCE-2.

22K400BW.TST Test file for frequency response of System One internal 22 kHz high pass and 400 Hz low pass filters.

2HD-FREQ.TST Test file for playback frequency response measurements, using either a tape recorded with 2HD-RCRD.TST or a reference tape.

2HD-PHAS.TST Test file for measuring interchannel phase of two-head tape recorders in playback mode using a pre-recorded tone.

2HD-RCRD.TST Test file to aid in creating a 30 step, frequency response test, for two-head tape recorders. Refer to section 30.2.4.4 for additional information.

2HD-THD.TST Test file for total harmonic distortion versus frequency of two head tape players using a per-recorded tape.

30K100BW.TST Test file for frequency response of System One internal 30 kHz high pass and 100 Hz low pass filters.

3H-DELAY.TST Test file to help determine the SETTling DELAY required for three head tape recorders at various tape speeds. Refer to section 30.2.4.2 for operating instructions.

3HD-AZIM.TST Test file for record head azimuth adjustment after the reproduce head has been adjusted, for three head recorders. Using ALT will provide a repeating five-frequency log spaced sweep from 1 kHz to 15 kHz, plotting interchannel phase as a function of frequency.

3HD-FREQ.TST Test file for frequency response testing of professional three head tape recorders. The test generates the test signal then delays measurement via SETTling DELAY until the tape has moved to the playback head. Channel (A) is tested then channel (B) in STEREO mode.

80K22HBW.TST Test file for frequency response of System One internal 80 kHz high pass and 22 Hz low pass filters.

AMP-DEMO.PRO Sub-procedure for SELECT.PRO procedure. Demonstration procedure testing frequency response APL-RESP.OVL, signal-to-noise ratio AMPNOISE.OVL, and distortion AMP-THD.OVL of DUT amplifier.

AMP-RESP.OVL Overlay file used in the AMP-DEMO.PRO procedure, to test amplifier frequency response. Punched-out fields are retained from the previous test or overlay.

AMP-THD.OVL Overlay file used in the AMP-DEMO.PRO procedure, to test amplifier distortion. Punched-out fields are retained from the previous test or overlay.

AMP-THD.TST Test file and data of power amplifier THD+N versus frequency resulting from operation of AMP-DEMO.PRO procedure.

AMP.TST Test file defining basic starting conditions for power amplifier test procedure AMP-DEMO.PRO.

AMPLCMRR.TST Test file for common mode rejection testing of DUT.

AMPLNOIS.TST Test file for producing spectral distribution of residual noise to 100 kHz of the DUT, also showing hum from power transformer and noise from computers display.

AMPNOISE.OVL Overlay file used in the AMP-DEMO.PRO procedure, to test amplifier signal-to-noise ratio. Punched-out fields are retained from the previous test or overlay.

AMPNOISE.TST Test file and data of power amplifier signal-to-noise ratio resulting from operation of AMP-DEMO.PRO procedure.

AMPRESP.TST Test file and data of power amplifier frequency response resulting from operation of AMP-DEMO.PRO procedure.

AV3HDFRQ.TST Test file for frequency response testing of professional three head tape recorders for (A) version hardware. The test generates the test signal then delays measurement via SETTling DELAY until the tape has moved to the playback head. Channel (A) and (B) are tested simultaneously in 2-CHANNEL mode.

AVCDFRQ1.TST Test file for Compact Disk stereo frequency response test for (A) version hardware. This test uses an external glide tone, such as track 65 on the Denon Audio Technical CD test disk 38C397147, as the test signal.

AVCDFRQ2.TST Test file for Compact Disk 2-CHANNEL frequency response test for (A) version hardware. This test uses discreet tones, such as track 46 through 55 on the Denon Audio Technical CD test disk 38C397147, as the test signal.

AZ-REPRO.TST Test file for reproduce head azimuth adjustment.

A_WEIGHT.TST Test file for acquisition and display of System One's "A" Weighting filter response.

BARGDEMO.PRO Procedure for an operator prompted adjustment step, using the mouse or arrow keys for frequency control. Sub-procedure called by SELECT.PRO procedure.

B_USASIOVL Test overlay file creating pulsed United States of America Standards Institute (USASI) noise, that closely simulates long term average spectra of typical audio program material.

CCIF-AM.TST Test file for measuring CCIF distortion versus amplitude.

CCIF-FRQ.TST Test file measures CCIF distortion versus Frequency.

CCIRFILT.TST Test file for displaying System One's CCIR filter response.

CCIR_2K.TST Test file for displaying System One's CCIR-2 filter response.

CD-DEMO.PRO Demonstration procedure testing compact disk frequency response CD-RESP.TST, and total harmonic distortion CD-THD.TST. Sub-procedure called by SELECT.PRO procedure.

CD-RESP.TST Test file for compact disk, frequency response measurements, using a glide tone increasing in frequency.

CD-THD.TST Test file for compact disk, total harmonic distortion measurements, using discrete tones increasing in frequency.

CDDITHER.TST Test file for spectral analysis of -90 dB dithered track & -90 dB undithered track of a CD player, using a CBS test disk.

CDFREQ2.TST Test file for Compact Disk Stereo frequency response testing. This test uses discrete tones, such as track 46 through 55 on the Denon Audio Technical CD test disk 38C397147, as the test signal.

CDPHASE.TST Test file for Compact Disk frequency response and interchannel phase testing. This test uses an external glide tone, such as track 65 on the Denon Audio Technical CD test disk 38C397147, as the test signal.

CDQUANTZ.TST Test file for measuring the quantization distortion of a compact disk player.

DEFAULT.TST Test file containing the standard power-up default settings of S1.EXE software.

DIM-AM.TST Test file for measuring dynamic intermodulation distortion versus amplitude using.

DIM-B.TST Test file for measuring dynamic intermodulation distortion versus amplitude, using a 14 kHz probe tone with the square wave component of the signal bandwidth limited to 30 kHz. Recommended for FM and TV audio testing because of their bandwidth limitations.

DIM100.TST Test file for measuring dynamic intermodulation distortion versus amplitude, using a 15 kHz probe tone with the square wave component of the signal bandwidth limited to 100 kHz.

DIM30.TST Test file for measuring dynamic intermodulation distortion versus amplitude, using a 15 kHz probe tone with the square wave component of the signal bandwidth limited to 30 kHz.

DIN.TST Test file for measuring "SMPTE" intermodulation distortion versus amplitude, using DIN-recommended frequencies of 250 Hz and 8 kHz.

DIST-PWR.TST Test file for measuring distortion at rated power versus frequency.

DSP-SHOW.PRO Procedure to demonstrate the waveform and spectral analysis capability of System One. Sub-procedure called by SELECT.PRO procedure.

FLTRSHOW.PRO Re-graphs typical frequency responses for System One full bandwidth, 22 Hz to 80 kHz bandwidth limiting, 100 Hz to 30 kHz bandwidth limiting, 400 Hz to 22 kHz bandwidth limiting, "CCIR" Weighting, CCIR-2K, and (A) Weighting filter selections.

FREQ-CON.TST Test file for frequency response where the output of the DUT must remain at a constant output level. A typical application is Proof-of-performance testing of broadcast transmitters and stations.

FREQRESP.TST Test file for frequency response test for balanced-input line level devices.

FULLBW.TST Test file for acquisition and display of System One's frequency response with no internal filters selected.

GAIN.TST Test file for measuring the gain or loss on a DUT. The DUT output is REGULATED to 0 dBu and the GENERATOR level is inverted and displayed in tabular format as a gain factor.

I-OPHASE.TST Test file for measuring the phase shift and frequency response of a device under test (DUT).

LOW-3DB.PRO Procedure to execute LOW-3DB.TST test to determine low frequency -3 dB point of an audio DUT. Sub-procedure called by SELECT.PRO procedure.

LOW-3DB.TST Test file to determine the low frequency -3 dB point of an audio DUT.

MOL.TST Test file for determining the maximum output level for a three head tape recorder, by measuring distortion versus amplitude.

NOISEFFT.TST Test file for display only of a dual trace spectrum analysis (FFT) of white and pink noise.

PEAKADJ.TST Test file example of the use of the mouse or arrow keys to for an example locate the maximum amplitude of a band-pass filter.

PWR-BAND.TST Test file for measuring power bandwidth of amplifiers.

RCRDNEST.TST Test file example of a nested sweep frequency response at four different levels, for a three head tape recorder.

READ-TST.TXT Brief description of Test and Procedures diskette.

RESIDNOL.TST Test file for acquisition and display of System One's residual noise spectrum at full bandwidth.

RESIDUAL.TST Test file for display only of spectrum analysis of the residual distortion of System One's analog generator and analyzer at 1 kHz.

SCRAPE.TST Test file for measuring scrape flutter versus time, using a 12.5 kHz test tone.

SELECT.PRO Provides a menu from which you can select each demonstration procedure.

SIGNOISE.TST Test file to make signal-to-noise ratio test on stereo or monaural devices.

SMPT-FRQ.TST Test file measures SMPTE intermodulation distortion versus Frequency.

SMPTE-AM.TST Test file uses the standard SMPTE test conditions of a 60 Hz low frequency tone mixed in a 4:1 amplitude ratio with a 7 kHz high frequency tone.

SMPTEFFT.TST Test file for display only of spectrum analysis of SMPTE-like IMD signal with 500 Hz low frequency and 7 kHz high frequency in a 4:1 amplitude ratio.

SMPTEWAV.TST Test file for display only of SMPTE-like IMD waveform with 500 Hz low frequency and 7 kHz high frequency in a 4:1 amplitude ratio.

SQUARFFT.TST Test file for display only of spectrum analysis of 1 kHz 1 Vrms square wave.

SQUARWAV.TST Test file for display only of 1 kHz 1 Vrms square wave.

SYS22CK.PRO Basic performance checks of system amplitude accuracy, ranging, flatness, frequency accuracy, residual distortion, noise, and phase accuracy. Use if the system is configured with dual outputs and inputs. Sub-procedure for SELECT.PRO procedure.

SYSBPN.LIM Upper compare limit for SYSBPN.TST tests.

SYSBPN.TST Test file for System One residual bandwidth bandpass noise.

SYSCAL.TST Test file for System One amplitude performance verification.

SYSCALL.LIM Lower compare limit for SYSCAL.TST tests.

SYSCALU.LIM Upper compare limit for SYSCAL.TST tests.

SYSCK.TXT Contains test results for SYSBPN.TST, SYSCAL.TST, SYSCMRR.TST, SYSFLAT.TST, SYSFREQ.TST, SYSHFTHD.TST, SYSPHASE.TST, and SYSTHD.TST tests.

SYSCMRR.LIM Upper compare limit for SYSCMRR.TST tests.

SYSCMRR.TST Test file for System One common mode rejection performance verification.

SYSFL.LIM Lower compare limit for SYSFREQ.TST tests.

SYSFLAT.TST Test file for System One frequency response flatness performance verification.

SYSFLATL.LIM Lower compare limit for SYSFLAT.TST tests.

SYSFLATU.LIM Upper compare limit for SYSFLAT.TST tests.

SYSFREQ.TST Test file for System One frequency calibration performance verification.

SYSFU.LIM Upper compare limit for SYSFREQ.TST tests.

SYSHFTHD.LIM Upper compare limit for SYSHFTHD.TST tests.

SYSHFTHD.TST Test file for performance verification of System One residual distortion at 500 kHz bandwidth. Called by SYS22CK.PRO sub-procedure.

SYSPHAL.LIM Lower compare limit for SYSPHASE.TST tests.

SYSPHASE.TST Test file for performance verification of System One phase measurement capability. Called by SYS22CK.PRO procedure.

SYSPHAU.LIM Upper compare limit for SYSPHASE.TST tests.

SYSTHD.LIM Upper compare limit for SYSTHD.TST tests.

SYSTHD.TST Test file for performance verification of System One's residual distortion at 80 kHz bandwidth. Called by SYS22CK.PRO procedure.

TAP-PHAS.TST Test file for measuring interchannel phase of three head stereo tape recorders.

TAPE-THD.TST Test file for measuring distortion versus frequency of a three head tape recorder.

THD-AM.TST Test file for measuring total harmonic distortion at a signal frequency of 1 kHz as a function of amplitude.

THD-FRQ.TST Test file for measuring total harmonic distortion plus noise versus frequency.

THDVSLVL.TST Test file for measuring total harmonic distortion plus noise versus measured level using DATA-2 as the horizontal axis.

UP-3DB.PRO Procedure to execute UP-3DB.TST test to determine high frequency -3 dB point of an audio DUT. Sub-procedure called by SELECT.PRO procedure.

UP-3DB.TST Test file to determine the high frequency -3 dB point of an audio DUT.

USASIOVL Test overlay file creating United States of America Standards Institute (USASI) noise, that closely simulates long term average spectra of typical audio program material.

VIEWALL.PRO Sequentially display all test data contained in current directory. Use (F10) to pause or continue procedure execution.

W&F.TST Test file for measuring International Electromechanical Commission (IEC) weighted wow and flutter and speed error versus time, using a 3.15 kHz test tape.

34.3. Utilities and Equalization Diskette

50US-DE.EQ Generator equalization file, for 50 microsecond de-emphasis curve.

50US-PRE.EQ Generator equalization file, for 50 microsecond pre-emphasis curve.

75US-DE.EQ Generator equalization file, for 75 microsecond de-emphasis curve.

75US-PRE.EQ Generator equalization file, for 75 microsecond pre-emphasis curve.

EQC.PRO Procedure to normalize the data created by EQCREATE.BAS to unity gain at a specified frequency, and to provide a menu selection to invert the curve if required.

EQCREATE.BAS Basic program to calculate equalization (EQ) file data.

EQCREATE.BAT Batch file to execute the EQCREATE.BAS basic program, then load System One and run the EQC.PRO procedure.

EQCREATE.DAT Data file for equalization curve values created by the EQCREATE.BAS program.

EQCREATE.EQ Equalization file used to preset DATA-1, and SOURCE-1 to appropriate units, so that the EQCREATQ.DAT data file can be loaded without panel unit mismatch errors.

EQCREATE.PRO Procedure to execute the EQCREATE.BAS basic program then normalize the data created by EQCREATE.BAS to unity gain at a specified frequency, and to provide a menu selection to invert the curve if an alternate curve type is required.

EQCREATE.TXT Text file that describes how to use the EQCREATE.BAS basic program to create a new equalization file using a mathematical formula, or to re-make one of the EQ files supplied on the Test and Utilities disk to optimize for speed, accuracy, or frequency range.

ISO15BND.SWP Sweep source file of center frequencies for a 15 band equalizer.

NRSC-DE.EQ Generator equalization file, for a National Radio Systems Committee (NRSC) de-emphasis curve. This curve is used to simulate the de-emphasis characteristics of an AM receiver.

NRSC-PRE.EQ Generator equalization file, for a National Radio Systems Committee (NRSC) pre-emphasis curve. This curve is used to provide a known treble boost to the audio for AM transmitters.

PLOT.EXE Executable program for use as part of System One's standard software. It drives any HPGL-compatible plotter and properly-equipped HP LaserJet printers to produce high resolution graphs.

POST.EXE Executable program for use with Apple LaserWriter and other PostScript-compatible printers to produce high resolution graphs.

RIAA-DE.EQ Generator equalization file, for a Recording Industry Association of America (RIAA) de-emphasis curve. This curve is used to provide a known low frequency boost for phonograph disk play back.

RIAA-IEC.EQ Generator equalization file, for a Recording Industry Association of America (RIAA) de-emphasis curve as modified by International Electromechanical Commission (IEC). This curve is used to provide a known treble boost and low frequency attenuation for phonograph disk play back.

RIAA-PRE.EQ Generator equalization file, for a Recording Industry Association of America (RIAA) pre-emphasis curve. This curve is used to provide a known high frequency boost for phonograph disk recording.

VERSION.TXT Text file that describes the operation of the program VERSION.EXE.

VERSION.EXE Executable program that determines and prints to the standard output the version of each Audio Precision test or procedure or DSP file encountered. The file dates and times are also printed.



35. INDEX

!

- % unit, 20-3
- %Hz, 8-5
- %ON unit, 20-2
- * (asterisk) print-screen, 15-3
- + key, 6-4, 8-3, 9-3
- .ADF file, 3-4
- /& filename command line option, 28-9
- /&, /B, /8 options used together, 28-9
- /- option, 15-6
- /3 option for HP LaserJet III, 15-7
- /8 option, 28-6
- /D# option, 5-7
- /F command line option, 15-3
- /F option, 15-3
- /G option, 15-6
- /I# option, 28-5
- /V#, 28-9
- 0.7746 Volts reference , 8-2
- 100 Volt operation, 4-1
- 110 baud
 - timeout value, 22-12
- 120 Volt operation, 4-1
- 150 Ohm system calibration, 8-3
- 2-CHANNEL mode, 10-3
- 2-sigma, 17-6
- 2-wire Ohms, 21-2
- 220 Volt operation, 4-1
- 240 Volt operation, 4-1
- 300 baud
 - timeout value, 22-12
- 4-wire Ohms, 21-2
- 50 Hz operation, 4-1
- 60 Hz operation, 4-1
- 6805, 32-3
- 80286, 27-4
- 80287 recommendation, 2-1
- 8086, 27-4
- 8087 recommendation, 2-1
- 8088, 27-4

A

- A vs B offset
 - switcher, 18-8
- A weighting filter, 10-7
- A-to-D conversion, analyzer, 32-3
- A-to-D converter linearity testing, 21-4
- A/D converter testing, 19-3
- Abort procedure, 25-12
- Absolute noise tests, 31-7
- Absolute vs relative distortion units, 8-4
- Ac mains requirements, 4-1
- Ac voltage setting, DCX-127, 4-1
- Ac voltage setting, SWR-122, 4-1
- Accuracy vs reading rate, 10-6
- Acknowledgement, 22-4
- Adding to procedures, 25-4
- Additive amplitude steps, 9-2
- Address conflict, 3-2
- Address port, 3-2
- Adjustment during tests, 14-1
- Adjustment operations in procedures, 14-5
- Advance of CD player track, 21-6
- AES-EBU digital audio format, 19-3, 19-7
- AES-EBU, status bytes, 19-7
- Allocation of memory, 28-6
- Alt F10, 25-13
- Alt F4, 8-4
- Alt F6, 13-11
- Alt F7, 11-11, 24-1, 24-3
- Alt X, 11-12
- Alt-F1 function key, 25-12
- Alt-F8 key, 11-18
- Amplitude
 - and frequency sweeps, 11-16
 - generator, 9-2
 - mode, 10-2
 - out of range, 9-2
 - range limitations, 9-3
 - resolution, tone burst, 20-3
 - sweeps, 11-1
 - tone burst, 20-3
 - units, 8-1
- Amplitude calibration

- in intermod mode, 16-2
- noise, 20-5
- squarewave, 20-5
- Amplitude control
 - generator, 32-4
- Amplitude measurement hardware requirements, 31-1
- Amplitude resolution
 - generator, 32-4
- Amplitude-frequency interactions, 9-7
- AMPSTEP, 9-2
 - and bargraph, 14-2
 - units, 9-2
- Analog control of generator, 14-1
- Analog control of generator frequency & amplitude simultaneously, 14-3
- Analog dc output voltage, 21-3
- Analog display of wow and flutter, 17-5
- Analog displays, 14-1
- Analysis bandwidth
 - CCIF IMD, 16-1
 - DIM-TIM IMD, 16-1
 - SMPTE IMD, 16-1
- ANALYZER, 10-1
- Analyzer block diagram, 32-1
- Analyzer digital conversion technique, 32-3
- Analyzer equalization, 13-17, 13-24
- Analyzer filter sweeps, 11-3
- Analyzer range, 10-9
- Analyzer Section, 10-1
- Analyzer Volts, 8-1
- Anti-alias filter, DSP, 19-6
- APBASIC, 5-1
- APLAST\$\$, 28-4
- APLAST\$\$ files, 13-3
- Appearance
 - of blanked fields, 25-11
- APPEND command
 - DOS, 5-4
- Append Data, 11-11
- Append Test, 11-11
- Append vs Image Store, 11-18
- Appending to procedures, 25-4
- Apple LaserWriter output, 15-16
- APTEMP\$\$GL, 15-8, 15-17
- Arbitrary control of generator in bargraph mode, 14-3
- Arbitrary equalization curves, 23-3 - 23-4
- Arbitrary sweep steps, 11-4

- Arrow key, 6-4
 - control of stimulus, 14-2
- Attaching error files, 13-16
- Attempts, 22-12
 - number of, 22-13
- Attenuator
 - generator, 32-4
- Audio chain testing via switcher, 18-16
- Audio link testing, 22-1
- AUTO
 - bandpass/bandreject filter frequency control, 10-5
- Auto algorithm for detector control, 10-6
- Auto quit at carrier loss , 22-12
- AUTO Range
 - analyzer, 10-9
- AUTO reading rate, analyzer, 10-6
- AUTO RESPONSE, SWEEP SETTling, 12-6
- Auto-answer, 22-8 - 22-9
- Autodial, 22-8 - 22-9
- AUTOEXEC.BAT
 - files, 28-1
- Automatic advance of CD player track, 21-6
- Automatic erase, 11-11
- Automatic erase not functional, 11-11
- Automatic set-up using environment, 28-11
- Automating system start-up, 28-1
- Autoranging
 - control, 32-1
 - dc voltage, 21-2
 - degrees, 8-6
 - peak sensitive, 10-8, 32-1
 - phase, 10-4
 - vs wow and flutter, 17-2
- Auxiliary input, 10-8
- Averaging noisy signals, 12-3
- Averaging readings for noise reduction, 12-2
- AVG detector use, 10-6
- Avoiding hangups with remote tests, 13-4
- Azimuth adjustments, 11-3, 31-13
 - record head, 31-13
 - reproduce head, 31-13

B

- Back termination
 - generator, 9-5, 32-4
- Balance adjustments, 11-15
 - A-version, 11-15
 - original hardware, 11-15
- Balanced output, 9-6

- Bandpass filter
 - frequency control, 10-5
 - in intermod testing, 16-3
 - mode, 10-3
 - options, 10-7
 - selectivity, 10-3
 - sweeps, 11-2 - 11-3
 - Bandpass noise
 - equalized, 20-6
 - mode, 20-6
 - Bandreject filter
 - frequency control, 10-5
 - mode, 10-3
 - rejection, 10-3
 - sweeps, 11-3
 - Bandwidth
 - wow and flutter, 17-2
 - Bandwidth control of frequency counter, 32-1
 - Bandwidth, DSP, 19-6
 - BARGDEMO, 6-2
 - Bargraph
 - amplitude control, 9-2
 - and AMPSTEP, 14-2
 - and FREQSTEP, 14-2
 - arbitrary control of generator steps, 14-3
 - display in stereo mode, 14-2
 - display of both channels, 11-15, 14-2
 - displays, 14-1
 - fixed phase range, 11-3
 - frequency control, 9-4
 - parameter selection, 14-2
 - peak hold, 14-2
 - printing, 14-5
 - printout, 15-6
 - stimulus control sensitivity, 14-3
 - third measurement parameter, 14-3
 - BASIC language control of System One, 5-1
 - Batch file
 - data comm, 22-9
 - for changing subdirectories, 25-16
 - in procedure, 25-15
 - Batch mode printing
 - plotter or laser printer, 15-13
 - PostScript laser printer, 15-20
 - Baud rate, 22-11
 - BCD format, digital input, 21-4
 - BCD format, digital output, 21-5
 - Bi-directional printing control, 15-4
 - Blank top line in procedure, 25-5
 - Blanked fields, 25-10
 - Block diagram
 - analyzer, 32-1
 - DSP input-output, 19-5
 - Boot
 - warm, 28-2
 - Bootable disk, 5-5
 - Booting the system, 5-6
 - Both outputs loaded, 9-3
 - BPASS noise mode, 20-6
 - Bps unit, 20-2
 - Branching
 - to another procedure, 25-6
 - upon operator input, 25-6
 - Branching upon error, 25-6
 - Broadcast station testing, 22-1, 26-1, 31-2
 - Broadcast transmitter testing, 23-1, 26-3, 26-6
 - Buffer size
 - determining, 28-11
 - Buffer size control, 28-7
 - Buffer swap to disk, 28-9
 - Buffer transfer, 13-11
 - Building up multiple-line graphs, 11-18
 - BUR option hardware, 32-4
 - BUR-GEN
 - in polarity testing, 10-5
 - Burst
 - amplitude, 9-7, 20-3
 - spacing, 20-2
 - units, 20-1
 - waveforms, 9-1
 - Burst hardware, 32-4
 - BURST ON field, 9-7
 - Burst waveform
 - display via DSP, 19-3
 - Bus mouse and PCI-2, 3-2
 - Bytes reserved for DOS, 28-11
 - Bytes vs points, data editor, 28-7
- C**
- C language control of System One, 5-1
 - Cable transposition testing, 10-5
 - Cables
 - unbalanced, 9-6, 10-8
 - Calibrating acoustical chambers, 23-1
 - Calibrating frequency, 9-4
 - Calibrating out system flatness variations, 23-5
 - Calibration cycle
 - manually invoking, 9-4

- time, high accuracy mode, 9-4
- Calling sub-procedures, 13-4, 25-6
- Capturing continuously-varying data, 12-7
- Causing procedure to pause until external event, 13-19
- CCIF
 - imd concepts, 16-1, 31-8
 - imd frequency spacing selection, 9-4
- CCIF imd architecture, 32-3
- CCIF imd signal generation, 32-4
- CCIR 468-4, 8-1, 10-6
- CCIR filter, 10-7
 - socket gain selection, 10-7
- CD player
 - quantization distortion, 31-10
 - SETTLING DELAY, 31-11
 - testing across a series of tracks, 31-3
 - testing with glide-tone test discs, 31-3
- Centering data between limits, 13-24
- Cents, 8-5
- CFL file type, 15-19
- CFP file, 15-12
- Changes in source or load impedance, 9-3
- Changing amplitude in steps, 9-2
- Changing graph title, 13-16
- Changing supply voltage connections, 4-1
- Changing test name, 13-17
- Channel A/B indicator, 21-7
- Channel balance adjustments
 - A-version, 11-15
 - original hardware, 11-15
- Channel exchange in stereo mode, 11-12
- Channel Monitor Output
 - AUTO vs fixed range, 10-10
- Channel number selection, 18-7
- Channel Selection
 - Input, 10-2
- Channel-matching adjustments, 11-15
- Characters
 - acceptable in file names, 13-6
- Chart recorder mode, 11-1 - 11-2
- Clipping
 - in analyzer with fixed ranges, 10-10
- Clipping tests, 26-3
- Clock, digital input, 21-4
- Cmrr vs reading rate, dc voltage, 21-2
- Co-processor recommendation, 2-1, 27-4
- Code, printer, 15-4
- Color
 - multiple traces, 11-10
- Color graph
 - conventions, 11-6
 - resolution, 11-4
- Color of nested sweeps, 11-16
- Color separation
 - from dot matrix printer, 15-6
- Color separations
 - HP LaserJet, 15-13
 - HPGL plotter, 15-13
 - PostScript laser printer, 15-19
- Color vs data
 - plotter, 15-10
- Columnar display, 11-9
- COM port number, 22-11 - 22-12
- COM1: and COM2:
 - setting PCI-2 card for, 3-2
- Combining command line options, 22-13, 28-4
- Command line options, 28-2 - 28-3
 - combining, 22-13
 - data comm, 22-12
 - multiple, 28-4
- Command Line Query, 28-10
- Command menu, 6-1, 13-3
- COMMAND.COM, 5-6
- Comments
 - attached to graph, 15-3
 - in listings, 25-5
- Comments printout, 15-3
- Comments with high-resolution graphs, 15-15
- Common mode
 - rejection ratio measurements, 8-3
 - rejection ratio reference, 10-8
 - test configuration, 9-6
- Communications port
 - number, 22-11
- Compact disc player
 - distortion testing, 31-10
 - response testing, 31-3
 - tests in stereo, 11-13
- Compact disc player testing
 - preserving reference level from test to test, 25-10
- Compatibility, DOS version, 5-5
- Compatibility, mouse, 3-1
- Compatibility, short slot, 3-3
- Complement mode
 - switcher, 18-8
- Complex waveform amplitude calibration, 8-1
- Composite graphs, 11-17

- Compressor testing, 11-17
- Compute
 - 2-sigma, 17-6
 - 2-Sigma menu command, 13-25
 - Center menu command, 13-24
 - Delta menu command, 13-24
 - Exchange, 11-12
 - Exchange menu command, 13-25
 - Invert menu command, 13-22
 - Linearity menu command, 13-22
 - menu commands, 13-20
 - Normalize, 13-20, 24-3
 - Normalize menu command, 13-20
 - Smooth menu command, 13-22
- Computer service bureau
 - compatible output, 15-20
- Computer system requirements, 2-1
- Computer type vs PCI-1 jumper position, 3-2
- Conditional
 - actions in procedures, 13-17
 - branching, 25-6
 - go to, 25-6
 - halt in procedure, 13-19
 - operators, 13-17
- CONFIG.SYS, 27-3
- Configuration file
 - plotter-laser printer, 15-12
 - PostScript laser printer, 15-19
- Configuring panels, 12-2
- Conflict in procedure version, 25-1
- Connector pin assignments
 - digital output ports A,B,C, 21-7
- Connector pin assignments, digital input-output, 21-4
- Console testing , 18-16
- Constant amplitude testing, 31-2
- Constant distortion tests, 26-3
- Constant modulation percentage, 26-1
- Constant power, 8-2
 - output, 26-1
 - testing, 26-3, 31-9
- Continuous sweeping signal measurements, 11-19
- Control
 - of buffer size, 28-7
 - of VCAs, 21-3
 - signal outputs, 21-6
 - voltage output, 21-3
- Control cable installation, 4-1
- Controlling
 - blanked field appearance, 25-12
 - output ports from panels, 21-7
- Converting pre-emphasis to de-emphasis, 23-4
- Copy buffer space occupied, 28-11
- CRCC, 22-3
- Creating
 - equalization files, 23-4
 - external sweep source signals, 11-20
 - limits files, 24-1
- Crest factor, 10-6, 10-8, 32-1
 - noise, 20-5
- Crosspoint switcher, 18-1
- Crosstalk
 - function, 11-13
 - measurements, playback only, 11-13
 - mode, 10-3
 - multi-track recorder, 18-16
 - reference, 10-8
 - worst case, 18-16
- Crosstalk (TM) data communications software, 22-8 - 22-9
- Crosstalk XVI (TM) data communications software, 22-9
- Ctrl F10 keystroke, 25-6
- Ctrl F3 operation, 26-5
- Ctrl F9, 11-10
- Current disk drive, 5-6
- Current limitations, 9-3
- Cursor, 6-3
 - control, with mouse, 29-2
 - graph, 6-3
 - graphic, 11-9
 - movement, 6-4
 - vs high-resolution graphs, 15-6
- Cursor movement magnification, 11-9
- Curve fitting
 - linearity, 13-22
- Custom keyboard, 21-5
 - definition, 13-9
 - function definition, 13-7
 - re-defining, 13-6
- Customizing system start-up, 28-1
- Cut and paste operations, 13-11
- CYCLES unit, 20-1 - 20-2
- Cyclic redundancy check code, 22-3
- Cycling through video attributes, 25-12

D

- D-to-A converter static testing, 21-5
- D/A converter testing, 19-3
- Daisy-chaining control cable, 4-1
- Danger in use of Util Out command, 25-14
- Data acquired pulse, 21-6
- Data averaging, 12-2
- Data columns
 - interchanging, 13-25
- Data comm
 - error message, 22-13
 - software, 22-6, 22-8
 - software requirements, 22-8 - 22-9
- Data management in tests, 25-15
- Data offset in stereo mode, 11-12
- Data packets, 22-3
- DATA plotting choices, 11-6
- Data ready, digital input, 21-4
- DATA SAMPLES error, 12-3
- DATA SAMPLES on sweep settling panel, 12-2
- Data storage by individual serial number, 25-16
- Data word width, 22-11
- DATA-n units vs ANALYZER panel units, 10-3
- dB unit, 8-3, 20-3
- dBm, 8-2
 - in 150 Ohms, 8-3
 - reference, 8-2, 10-9
 - vs dBu, 8-2
- dBr, 10-8
 - (relative dB), 8-3
 - and POST-EQ, 9-3
 - for distortion readings, 10-9
 - reference, 9-3
 - reference setting priorities, 10-9
 - reference, analyzer, 10-8
 - reference, carrying from test to test, 25-10
 - units, distortion, 8-3
- dBu, 8-2
 - vs dBm, 8-2
- dBV, 8-3
- Dc output, swept, 21-3
- Dc voltage
 - measurements, 21-1 - 21-2
 - output, 21-3
 - plots, 11-7
 - range and resolution, 21-2
 - reading rate, 21-2
 - sweeps, 11-1
- DCX-127
 - functions, 21-1
 - rear panel output ports, 21-7
- De- vs pre-emphasis, 23-4
- De-bugging procedures, 25-13
- De-emphasis, 23-1, 23-3, 31-3
- Decades, 8-5
- Decimal control of digital output ports, 21-7
- Decimation, DSP, 19-6
- Decrement amplitude, 9-2
- Decrement frequency, 9-4
- Default conditions
 - user selectable, 28-3
- Default drive, 5-6
- Degree units
 - deg, 8-6
 - deg, deg1, deg3, 10-4
 - deg1, 8-6
 - deg2, 8-6
 - deg3, 8-6
- Del key, 6-4, 8-3, 9-3
- Delay gate, 21-7
- Delay in dBr REF setting, 10-9
- Delay time in 3-head tape recorder testing, 12-5
- Delays in procedures, 13-19
- Delete buffer, 13-11
- Deletions from text, 13-11
- Delimiters in limits files, 24-1
- Delta %, 8-5
- Delta Hz, 8-5
- Delta PPM, 8-5
- Desktop publishing
 - encapsulated Postscript files, 15-20
 - PLOT.EXE, 15-12
- Detector
 - recommendation, 10-6
 - selection, 10-6
 - time constant, switching during sweeps, 12-6
 - type for scrape flutter, 17-2
- Determining delay time, 31-4
- Deviation from perfect linearity, 13-22
- Device control, 13-18
- Difference-tone intermod theory, 16-1
- Differential voltmeter mode, DCX-127, 21-5
- Digit keypad, 6-3
- Digital input, 21-3
 - format, 21-4
 - plots, 11-7
 - reading rate, 21-4
- Digital input-output measurements, 19-3

- Digital interface cable connections, 4-1
 - Digital output, 21-4
 - control ports, 21-7
 - sweeps, 11-1
 - Digital recorder
 - distortion vs frequency, 19-3
 - Digital Signal Processor, 19-1, 19-3
 - Digital system tests, 10-7
 - DIM
 - imd architecture, 32-3
 - imd concepts, 31-8
 - intermod theory, 16-1
 - test signal generation, 32-4
 - DIN
 - imd concepts, 31-7
 - imd test signal generation, 32-4
 - intermod testing, 16-1
 - wow and flutter, 17-1 - 17-2
 - Direction of external sweep, 11-19
 - Direction of sweeps, 11-3
 - Disabling Image Store for more memory, 28-6
 - Disk access
 - during limits testing, 27-2
 - in EQSINE mode, 27-2
 - Disk directory for EQCREATE.BAS, 23-3
 - Disk drive recommendations, 2-1
 - Disk Operating System, 5-5
 - Disk space requirement
 - temporary graphics file, 15-8, 15-17
 - Disk type
 - impact on speed, 27-3
 - Diskette copying, 5-5
 - Diskettes
 - System One software, 5-1
 - Disks
 - virtual (ram), 27-3
 - Display mode vs graph labeling, 11-7
 - Display None for speed, 27-1
 - Display of exact graphic values via cursor, 11-9
 - Display Table printout, 15-6
 - Displaying
 - both stereo channels simultaneously, 11-15
 - generator amplitude, 26-6
 - limits while testing, 24-3
 - Distance in remote controlled systems, 22-1
 - Distortion
 - at constant power, 31-9
 - dBr measurements, 8-3
 - increase with fixed range, 10-10
 - tape recorder testing, 31-9
 - testing vs amplitude, 31-8
 - testing vs frequency, 31-8
 - two-head recorder testing, 31-10
 - Distortion analyzer architecture, 32-3
 - Distortion vs. output level curves, 11-16
 - Dither, 19-7
 - Division marks
 - horizontal, 11-2
 - vertical, 11-7
 - Dolby CCIR-ARM, 10-7
 - DOS, 5-5
 - APPEND command, 5-4
 - bytes reserved for, 28-11
 - commands in procedures, 25-15
 - controlling available memory, 28-6
 - increasing available memory by disabling Image Store, 28-6
 - menu command, 13-3
 - version compatibility, 5-5
 - DOS activities
 - increasing available memory by swapping buffers to disk, 28-9
 - Dot matrix printer
 - landscape mode, 15-5
 - portrait mode, 15-6
 - Downloading
 - DSP programs, 19-5
 - stored waveforms to DSP module, 13-6
 - Driving all but one channel of switcher, 18-8
 - Driving all channels of switcher, 18-8
 - Dropout level in external sweeps, 12-6
 - DSP, 19-1, 19-3
 - frequency response, 19-7
 - DSP bandwidth, 19-6
 - DSP FFT, 19-3
 - DSP Panel, 19-6
 - DSP program download, 19-5
 - DSP Rates, 19-6
 - DSP Units, 8-6
 - DSP waveform download, 13-6
 - Dual sensitivity graphs, 11-10
 - Dwell time
 - external sweep, 11-19
- E**
- Earth connections, 4-1
 - Edit
 - Data menu command, 13-9

- Macro menu command, 13-9
- menu commands, 13-9
- Procedure menu command, 13-9
- Edit comment buffer
 - control of size, 28-7
- Edit data buffer
 - control of size, 28-7
- Edit macro buffer
 - control of size, 28-8
- Edit procedure buffer
 - control of size, 28-7
- Editing procedures, 25-3 - 25-4
- Editor
 - capability, 13-11
 - control keys, 13-14
 - text, 13-11
- Eliminating attached files, 13-17
- Encapsulated Postscript files, 15-20
- Enter key equivalent in procedure edit mode, 25-5
- Environment
 - using to control start-up, 28-11
- EPS files, 15-20
- Epson printer, 15-3
- EQ file
 - control of size loaded into memory, 28-7
- EQBPN noise mode, 20-6
- EQCREATE, 23-3
- EQSINE, 23-1
- Equalization
 - analyzer, 13-17
 - files, attaching to generator, 13-15
 - files, creating, 13-20, 13-22, 23-4
 - files, direction vs test file direction, 27-2
 - files, disconnecting, 13-17
 - files, inverting, 23-5
 - files, normalizing, 23-4
 - interpolation during, 23-1
- Equalization curves
 - arbitrary, 23-3 - 23-4
- Equalized bandpass noise, 20-6
- Equalized mode selection, 9-1
- Equalized power amplifiers
 - testing of, 23-1
- Equalizer testing, 31-2
- Equivalent power, 10-6
- Erase
 - automatic, 11-11
- Error
 - branching upon, 25-6

- Error file, 24-3 - 24-4
 - attaching, 13-16
 - disconnecting, 13-17
 - summary, 24-2
 - temporarily disconnecting, 13-16
- Error message
 - data comm, 22-13
- Error printout, 15-6
- Errors
 - correcting numeric entry, 6-4
- Even vs odd order intermod testing, 16-3
- Examining attached file names, 24-2
- Example tests, 6-1
- Expansion slots, 3-3
- Exponential notation, 6-4
- Exponential sweep settling, 12-3
- EXT SOURCE SAMPLES in external sweeps, 12-6
- External amplitude sweeps
 - function, 11-19
- External clock for digital input, 21-4
- External device control, 13-18, 25-14
- External filters, 10-7
- External frequency sweep
 - function, 11-19
 - use of low-pass filter during, 11-19
- External source sweeps, 11-1
- External stereo sweeps, 11-20
- EXTERNAL sweep, 11-19, 12-6
 - creating test signal sources, 11-20
 - direction, 11-3
 - modes, 11-20
 - preparing test tapes for, 12-5
 - reading rate, 10-6
 - recording test tape for, 23-2
 - sources with reference signal preceding, 11-20
 - sources with voice announcements, 11-20
 - stereo, 11-13
 - sweep-erase-repeat mode , 11-20
 - termination of in procedures, 11-20
 - with continuously-varying analog source, 12-6

F

- f(V), 21-2
- f(W), 21-2
- F/R, 8-5
- F1 function key, 25-12
- F10 function key, 25-12
 - in time measurements, 11-6

- F3 function key, 9-3
 - and POST-EQ, 9-3
- F4 function key, 10-8
 - priorities, 10-9
- F8 key, 11-18
- F9 Function key, 11-9
- Factors affecting sample time during time sweeps, 11-6
- Factors affecting speed, 27-1
- Failure
 - data comm, 22-13
 - tag, 24-4
 - to overlay images, 11-18
 - to run procedure, 25-1
- FAST frequency mode, 9-4
- Fast graphs, 15-3
- FASTEST
 - and speed, 27-4
- FBP option bandpass filters, 10-7
- FFT
 - spectrum analysis of residual distortion, 19-3
- Fields
 - multiple choice, 6-4
 - numeric entry, 6-4
- File names
 - acceptable characters, 13-6
- File size, 13-7
- Filling in forms in procedure, 25-13
- Filter frequency sweeps, 11-3
- Filter frequency tuning, 10-5
- Filter socket #1 gains, 10-7
- Filter switching during sweeps, 12-6
- Filters, 10-7
 - bandpass and bandreject, 10-3, 10-5
 - external, 10-7
 - high frequency, 10-7
 - high-pass, 10-7
 - low frequency, 10-7
 - optional, 10-7
 - weighting, 10-7
- Fixed degree unit, 8-6
- Fixed disk computers, 5-1
- Fixed phase range, 10-4, 11-3
- Fixed range
 - analyzer, 10-9
- Fixed range, dc voltage, 21-2
- Fixed response
 - sweep settling , 12-6
- Flatness
 - improving, 23-5
- Floating mode, generator, 9-7
- Flow control
 - procedures, 25-5
- Flutter
 - in test tapes, 17-5
 - problems in tape testing, 31-5
 - record-keeping for maintenance, 17-4
 - tests in simultaneous record-playback mode, 17-4
- Font selection
 - PostScript laser printer, 15-19
- Footswitch control of System One, 21-5
- Form creation in procedure, 25-13
- Form feed, manual, 15-4
- Format disable, printout, 15-3
- Format, digital input, 21-4
- Format, digital output, 21-5
- Formatting diskettes, 5-6, 28-1
- Formula-based equalization, 23-3 - 23-4
- Four wire Ohms, 21-2
- FREQSTEP, 9-4
 - and bandpass noise, 20-6
 - and bargraph, 14-2
- Frequency and amplitude sweeps, 11-16
- Frequency control modes, 9-4
- Frequency control, bandpass noise, 20-6
- Frequency counter, 10-4
 - architecture, 32-1
 - bandwidth, 11-19
 - low-pass filtering, 32-1
- Frequency counter sensitivity, increasing, 10-4, 32-1
- Frequency counter-input channel relationship, 32-1
- Frequency direction of .EQ file, 23-2
- Frequency end points of .EQ file, 23-2
- FREQUENCY function, analyzer, 10-4
- Frequency increment and decrement, 9-4
- Frequency limitation, squarewave, 20-5
- Frequency measurement
 - of complex signals, 32-1
 - selective, 10-4, 32-1
- Frequency modulation
 - tape and disc, 17-1
- Frequency range switching, 32-4
- Frequency recommendation for scrape flutter, 17-1 - 17-2
- Frequency reference, 10-9
 - setting, 8-4
- Frequency response

- at constant output amplitude, 11-7
- concepts, 31-1
- DSP, 19-7
- measurements, 8-3
- reference, 10-8
- Frequency restriction
 - intermod testing, 16-2
- Frequency settling time, 9-4
- Frequency sweeps, 11-1
- Frequency sweeps of filter, 11-3
- Frequency vs. reading rate, 10-6
- Frequency, tone burst, 20-1
- Frequency-amplitude interactions, 9-7
- Function
 - of dc voltage, 21-2
 - of external frequency sweep, 11-19
 - of external level sweep, 11-19
 - of resistance, 21-2
- Function key listing, 13-14
- Function monitor output, 32-3
- Function selection, 10-2
- Fuse ratings, 4-1

G

- Gain and loss
 - concepts, 31-6
 - measurements, 8-3
 - reference, 10-8
- Gain selection of socket #1, 10-7
- Gain steps
 - at Monitor Output, 10-10
- Gap scatter, 18-16
- Gate control requirements, 20-4
- Gated burst, 20-1
- Gated operation, 20-4
- Gated signal amplitude, 20-3
- Gated sweeps, 23-2
- GDL file, 15-6
- GDL files
 - vs graphics cursor, 15-6
- Gen None display, 11-9
- Gen None sweeps, 11-2
- Gen Sync output, 32-5
- Gen-Mon function with separate generator and analyzer, 4-1
- Gen-Monitor cable connection, 10-8
- Generator
 - auxiliary outputs, 32-5
 - back termination, 9-5

- conditions during sweep, 11-2
- connector pin assignments, 9-6
- control via bargraph, 14-2
- control via mouse, 14-2
- frequency control, 9-4
- imd mode selection, 9-1
- inverse amplitude, 11-7
- load resistance, 8-2, 9-3
- monitor, 10-8
- on-off control, 9-5
- output current capability, 9-3
- output impedance, 9-5, 9-7
- Generator amplitude
 - calibration vs dual outputs, 9-3
 - changes with different units, 9-2
 - control, 9-2
 - limits in regulation mode, 26-2
 - resolution, 32-4
- Generator circuit discussion, 32-4
- Generator equalization
 - attaching file name, 13-15
- Generator frequency
 - limits in regulation mode, 26-2
- Generator imd option, 32-4
- Generator monitor output, 32-5
- Generator power amplifier, 32-4
- Generator synch signals, 32-5
- Generator-based sweeps, 11-3
- Glide-tone
 - compact disc player testing, 31-3
 - signal measurement, 11-19
 - testing, 12-7
- Go To command, 13-19
- Go To Statement, 25-6
- Go/No-Go testing, 24-1
- GPIB systems, 25-15
- Graph
 - labeling vs display mode, 11-7
 - limits, horizontal, 11-3
 - margins for comments alignment, 13-9
 - re-plotting, 11-10
 - title replacement, 13-16
- Graph position
 - PLOT.EXE, 15-9
 - POST.EXE, 15-17
- Graph printout
 - multiple per page, 15-3
- Graph printout with text, 15-3
- Graph size

- control, 15-4
 - PostScript laser printer, 15-17
 - vs quality, 15-4
- Graph with comments, 15-3
- Graph without grid, 15-6
- Graphic coordinate match for image store, 11-18
- Graphic cursor, 6-3, 11-9
 - vs high-resolution plots, 15-6
- Graphic printout, 15-1
 - monochrome vs. color, 11-9
- Graphic resolution limits, 11-4
- Graphic retrace without plotting, 11-17
- Graphics system conflict, 5-7
- Graphing
 - dc voltage, 11-7
 - digital input, 11-7
 - limits on screen, 11-11, 24-1, 24-3
 - resistance, 11-7
- Graphs, 15-3
 - changing units, 11-10
 - fast printout, 15-3
- Grid
 - eliminating from graph, 15-6
- Ground loop noise, 4-1
- Ground loops, avoiding, 10-8
- Ground, protective, 4-1
- Grounded mode, generator, 9-7

H

- Halt procedure, 25-12
- Hangup in sweep testing, 12-4
- Hard copy graphs, 15-1
- Hard disk computers, 5-1
- Hardware reset, 13-18
- Head height adjustment, 11-15
- Header
 - procedure, 25-1
- Help
 - editor keys, 13-14
 - function keys, 13-14
 - overlay keys, 13-14
- HELP DSP, 13-14
- Help menu commands, 13-14
- Hercules
 - graphics, 11-4
 - monochrome graph resolution, 11-4
- Hexadecimal control of digital output ports, 21-7
- Hexadecimal entry of digital output word, 21-4
- Hi Bound, 26-2

- High Band
 - flutter modes, 17-1
 - vs conventional flutter measurements, 17-2
- High pass filter
 - switching during sweeps, 12-6
- High sensitivity frequency measurement, 10-4
- High-resolution graphs, 15-6
 - vs graphics cursor, 15-6
- Hingh-accuracy frequency control mode, 9-4
- Hor-Axis, 11-11
- Horizontal divisions, 11-2
- Horizontal limits, 24-1
- HP LaserJet, 15-3
 - high resolution output, 15-7
- HP LaserJet III
 - comments under graph, 15-15
 - necessary command line option, 15-7
- HPGL file, 15-12
- HPiB systems, 25-15
- Hum in stereo system testing, 9-6, 10-8

I

- I/O address, 3-2
- IBM PC installation, 3-3
- IEC
 - flutter standard, 17-4
 - wow and flutter, 17-1
- IEEE-488 systems, 25-15
- If
 - #, 13-18
 - Above menu command, 13-18
 - Below menu command, 13-18
 - Error menu command, 13-17 - 13-18
 - menu commands, 13-17
 - Noterror Menu Command, 13-18
- If statement, 25-6
- Illustration
 - PLOT.EXE, 15-12
 - POST.EXE, 15-19
- Image Save, 11-10, 11-17
- Image Store
 - control keys, 11-18
 - example, 11-18
 - vs memory size, 28-6
- Image Store vs Append, 11-18
- IMD
 - architecture, 32-3
 - frequency selection, 16-2
 - generator mode selection, 9-1

- modes, 10-3
 - option, generator, 32-4
 - power measurements, 16-4
- In-phase vs out-of-phase testing, 10-5
- Incidental amplitude modulation
 - measurement of, 16-1
- Incorporating bargraphs in procedures, 14-5
- Increasing dc voltmeter resolution, 21-5
- Increment frequency, 9-4
- Increment-decrement
 - switcher channel, 18-8
- Independent units in stereo mode, 11-12
- Individual harmonic distortion, 10-7, 31-7
- Input channel connections to meters, 32-1
- INPUT MONITOR connector, 32-1
- INPUT RANGE
 - how to fix, 10-10
- Input-output
 - DSP, 19-5
- Input-output offset
 - switcher, 18-8
- Input-output phase, 10-4
- Inserting messages to operator, 13-19
- Insertion switchers
 - in broadcast testing, 22-1
- Installation
 - IBM PC, 3-3
- Instructions to user on bargraphs, 14-5
- Insufficient memory error, 6-1
- Interchanging data columns, 13-25
- Interface card, 3-1
 - command line options, 28-5
 - error message, 28-5
 - IBM PS/2, 3-1
 - Microchannel bus, 3-1
 - using software without, 28-5
- Interference during testing, 10-8
- Intermod generator
 - amplitude calibration, 16-2
- Intermodulation distortion
 - available measurement units, 16-2
 - frequency restrictions, 16-2
 - frequency selection, 9-4
 - generator mode selection, 9-1
 - signal amplitude calibration, 8-1
 - swept measurements, 16-4
 - testing standards on diskette, 16-2
 - theory, 16-1
 - units, 8-4

- Interpolation
 - during equalized sweeps, 23-1
- Interrupt address conflict, 3-2
- Interrupting procedures, 25-12
- Interrupting sweeps, 11-9
- INTERVAL field, 9-7
- Interval, tone burst, 20-2
- Invalid buffer size error message, 28-8
- INVAMP, 11-7
- Inverse amplitude of generator, 26-6
- Inverting data files, 13-22

J

- JIS
 - wow and flutter, 17-1
- Jitter measurements
 - settling for, 12-3
- Jumper position vs computer type, PCI-1, 3-2
- Jumpers, mouse, 3-2
- Jumpers, PCI-1 card, 3-2
- Jumping to another procedure, 25-6
- Jumping to panel fields, 25-10
- Jumping within procedures, 13-19, 25-6

K

- Kelvin connection, 21-2
- Keyboard
 - custom, 13-7
 - definition for production test, 13-9
 - limited-function, 21-5
- Keyboard input during procedures, 25-6
- Keypad
 - numeric, 6-4
- Keystroke learning process, 13-19
- Keystroke sequences for control, 13-7
- Keystrokes on panel
 - in procedures, 25-2
- Kilo prefix, 6-4

L

- Labels, 13-25
- Labels in procedures, 25-6
- Lamp control, 21-7
- Landscape mode
 - dot matrix printer, 15-5
- Laptop computer, 22-3
 - operation, 22-5
 - speed of operation, 22-11

- Large digits, 14-2
 - Laser Plotter, 15-7
 - Laser Plotter software, 15-15
 - Laser printer output, 15-6
 - Laser printers
 - Pen width for, 15-12
 - LaserJet, 15-3
 - high resolution output, 15-7
 - LaserJet III
 - necessary command line option, 15-7
 - LaserWriter
 - line style vs data, 15-19
 - output, 15-16
 - Lead dress
 - terminal strip switcher, 18-5
 - Learn mode, 25-2
 - Learning macros, 13-10
 - LEVEL function, 10-4
 - performance limitations, 10-4
 - LIB-BASIC, 5-1
 - LIB-C, 5-1
 - LIB-MIX, 5-1
 - Limit file
 - control of size loaded into memory, 28-7
 - creation of, 24-1
 - delimiters, 24-1
 - direction vs test file direction, 27-2
 - disconnecting, 13-17
 - table, 24-1 - 24-2
 - Limit in number of steps, 11-3, 11-10
 - Limited-function keyboard, 21-5
 - definition, 13-7, 13-9
 - re-defining, 13-6
 - Limits
 - for testing, 24-1
 - horizontal, 24-1
 - single-value, 24-1
 - Limits, graphing on screen, 11-11, 24-1, 24-3
 - Line frequency compatibility, 4-1
 - Line labels, 13-25
 - in procedures, 25-6
 - Line style
 - plotter-laser printers, 15-10
 - PostScript laser printer, 15-18
 - Line voltage requirements, 4-1
 - Linear algorithm for regulation, 26-2
 - Linear sweeps, 11-3
 - Linearity testing, 13-22
 - Linking sub-procedures, 25-7
 - Lo Bound , 26-2
 - Load
 - commands, common features, 13-5
 - Comment menu command, 13-5
 - Data menu command, 13-6
 - EQ menu command, 13-6
 - Limit menu command, 13-5
 - Macro menu command, 13-6
 - menu commands, 13-5
 - Overlay menu command, 13-6
 - Procedure menu command, 13-6
 - Sweep menu command, 13-5
 - Test menu command, 13-5
 - Waveform menu command, 13-6
 - Loading files from any specified directory
 - APPEND command, 5-4
 - Loading output port control with test, 21-7
 - Loading procedures, 25-1
 - Local operation, 13-4
 - Log divisions
 - significant figures, 11-7
 - Log graph end points, 11-3
 - Logarithmic steps
 - manual, 9-2
 - Logarithmic sweeps, 11-3
 - Logic control, 21-7
 - Looping upon error, 25-8
 - Loss measurements, 8-3
 - Loudspeaker response smoothing, 13-22
 - Low frequency filter
 - switching during sweeps, 12-6
 - Low Lvl field, 9-7
 - Low Lvl of burst, 20-3
 - Low pass filter use in external frequency sweep, 11-19
 - Low resistance measurements, 21-2
 - Lower limits
 - attaching, 13-15
- M**
- Macro preparation, 13-9
 - Macros, 21-5
 - learning, 13-10
 - Main oscillator, 32-4
 - Main Voltmeter, 10-2
 - Mains voltage setting, DCX-127, 4-1
 - Mains voltage setting, SWR-122, 4-1
 - Making limit files, 24-1
 - Making sweep tests, 11-9

- Making test tapes for auto-stop, 11-21
- Malfunction due to mouse interaction, 3-2
- Manual position
 - PostScript laser printer, 15-18
- Manual positioning of plotter graphs, 15-10
- Master error file, 24-4, 25-15
- Matching stereo channel amplitudes, 11-15
- Math co-processor recommendation, 2-1, 27-4
- Maximizing number of points, 28-7
- Maximum algorithm, 26-4
- Maximum indication
 - bargraph, 14-2
- MDAC
 - generator control, 32-4
- MDAC testing, 21-5
- MEASURE, 10-2
- Measured parameter on horizontal axis , 11-16
- Measurement of two channels, 10-3
- Measuring generator amplitude, 10-8
- Memory
 - allocation of, 28-6
 - increasing amount for DOS by swapping buffers to disk, 28-9
- Memory allowance
 - for BASIC program, 23-3
- Memory available for DOS
 - control of, 28-6
- Memory buffer size control, 28-7
- Memory control using environment, 28-11
- Memory requirements, 2-1, 6-1, 28-6
 - PLOT.EXE, 15-7
 - POST.EXE, 15-17
- Menu
 - command, 13-3
 - PLOT.EXE, 15-8
 - POST.EXE, 15-17
- Menu command, 6-1
- Menu example in procedure, 25-8
- Menus within procedures, 25-6
- Merging data, 11-11
- Messages to operator, 13-19
- Micro prefix, 6-4
- Microchannel bus installation, 3-4
- Microchannel bus interface card, 3-1
- Microphone testing, 26-1, 26-3
- Microprocessor
 - internal LVF, 32-3
- Microprocessor types, 27-4
- Milli prefix, 6-4
- Min Lvl in external sweeps, 12-6
- Minimum acceptable delay, 31-4
- Minimum algorithm, 26-4
- Mnemonic codes to jump to panel fields, 25-10
- MODE command, 22-11
 - serial plotter control, 15-13
- Mode, printer (table), 15-4
- Modems, 22-1, 22-6, 22-8
- MOL
 - at multiple frequencies, 11-17
 - curves, 11-16
 - testing, 26-1, 26-3, 31-9
- Monitor connections, 32-1
- Monitor Output
 - AUTO vs fixed range, 10-10
 - generator, 32-5
- Monochrome graph resolution, 11-4
- Monochrome stored image on color displays, 11-18
- Monotonic sweep tables, 11-5
- Mouse
 - compatibility, 3-1
 - compatibility vs PCI-1, 29-1
 - conflict, PCI-2 card, 3-2
 - control of stimulus, 14-2
 - functions, 29-1
 - jumpers, 3-2
 - serial, 29-1
 - serial, with PCI-1 card, 29-1
 - two-dimensional, 14-3
 - usage, 29-2
- MOUSE.COM, 5-7, 29-2
 - with serial mouse, 29-1
- Move but don't draw, 11-17
- Moving data between buffers, 13-11
- Moving the cursor, 6-1, 6-4
- Multi-track
 - example error file, 18-15
 - frequency response, 18-13
 - gap scatter, 18-16
 - recorder crosstalk, 18-16
 - recorder noise, 18-15
 - tape machine switcher example, 18-12
 - tape recorder alignment, 14-2
- Multiple choice fields, 6-4
- Multiple command line options, 22-13, 28-4
- Multiple graphs on page
 - plotter or laser printer, 15-10
 - PostScript laser printer, 15-17

Multiple graphs per page, 15-3
 Multiple sweeps, 11-10
 Multiple-track CD player testing, 31-3
 Multiplex stereo testing, 9-5
 Multiplicative amplitude steps, 9-2
 Musical tone values, 8-5

N

NAB
 flutter standard, 17-4
 wow and flutter, 17-1

Names
 Clear menu command, 13-17
 Delta menu command, 13-17
 Err-File menu command, 13-16
 GEN-EQ menu command, 13-15
 Lower menu command, 13-15
 menu commands, 13-14
 Off menu command, 13-16
 Program command, 19-5
 Rename menu command, 13-17
 Sweep menu command, 13-15
 Title menu command, 13-16
 Upper menu command, 13-15

Nano prefix, 6-4

Nested sub-procedures, 25-7

Nested sweep, 11-16
 limitations, 11-17
 panel setup, 11-16

Nesting switcher scans, 18-10

No-display mode, 11-9

Noise
 amplitude calibration, 20-5
 bandwidth, white, 20-5
 crest factor, 20-5
 generation hardware, 32-5
 in stereo system testing, 10-8
 in unbalanced systems, 9-6
 increase with fixed range, 10-10
 problems due to computer crt monitor, 30-1
 reduction by averaging, 12-2 - 12-3
 rejection, frequency counter, 32-1
 sweep to detect problem sources, 30-1
 waveforms, 9-1

Non-conversion between relative and absolute THD+N units, 8-4

Normal algorithm, 26-3

Normal mode rejection vs reading rate, dc voltage, 21-2

Normalizing data files, 13-20
 Normalled-through connection, 18-2
 Notch filter
 frequency control , 10-5
 Notch mode, 10-3
 Null modem, 22-5
 Nulling adjustments, 14-1
 Num Lock key, 6-3 - 6-4
 Number of data points
 maximizing, 28-7
 Number of points in .EQ file, 23-2
 Number of steps recommended, 11-4
 Numeric display of exact graphic values, 11-9
 Numeric entry fields, 6-4
 Numeric keypad, 6-4

O

Occupied bandwidth testing in amplitude modulation broadcast systems, 20-6
 Octal control of digital output ports, 21-7
 Octal entry of digital output word, 21-4
 Octaves, 8-5
 OFF level, generator, 9-5
 Off-screen operation of bargraph, 14-2
 Offset
 switcher, 18-8
 Offsetting
 dc measurements, 21-2
 dc voltage measurements, 21-2
 resistance measurements, 21-2
 Offsetting data for use as limit file, 24-3
 One-third octave filter, analyzer, 10-3
 One-third octave frequency steps, 9-4
 Operator input during procedures, 25-6
 Operator prompt, 25-12
 Operator test selection in procedure, 25-8
 Optimum detector selection, 10-6
 Optimum sweep direction, 11-3
 Oscilloscope monitoring, 32-1
 Output circuitry
 generator, 32-4
 Output configurations, generator, 9-6
 Output impedance, generator, 9-7
 Outputs via printer port, 13-18
 Over-riding page feed after graphic printout, 15-3
 Over-writing files, 13-6
 Overall sweep speed, 27-2
 Overlay files, 25-10
 Overlay to control output port, 21-7

Overlays, 25-10
 Overload
 with fixed analyzer ranges, 10-10
 Overload, generator, 9-3

P

P121, P421, 3-2
 P321, P322, P323, P324, 3-2
 Packets, 22-3
 Page feed
 from laser printer, 15-10
 Page feed after graph, 28-10
 Page Up and Page Down keys, 12-2
 Panel
 exchange via PgUp, 12-2
 for nested sweep, 11-16
 menu command, 13-3
 printout, 15-6
 return to original default, 12-2
 selection, 12-2
 setups in procedures, 25-9
 Panel fields
 jumping to, 25-10
 Parallel port control, 25-14
 Parameter passing, 13-6, 13-8, 25-10
 Parity, 22-11
 Parts per million, 8-4
 Pass/Fail testing, 24-1
 Passed parameters, 13-6
 Patch point switcher, 18-1 - 18-2
 channel selection, 18-7
 description, 18-2
 in broadcast testing, 22-1
 Path name, 11-5
 Pause
 during sweeps, 11-9
 during time measurement, 11-6
 for operator action, 25-12
 in procedures, 25-12
 until external event, 13-19
 PCI card installation, 3-2
 PCI-1 card, 3-1
 PCI-2 card, 3-1
 PCI-3 card, 3-1
 PCI-3 card installation, 3-4
 Peak equivalent sinewave, 10-6
 measurements, 16-4
 Peak hold
 bargraph, 14-2

 in Peak and Q-Pk mode, 10-6
 Peak sensitive autoranging, 10-8
 Peaking adjustments, 14-1
 Pen plotter output, 15-6
 Pen vs data
 plotter, 15-10
 Pen width for laser printers, 15-12
 Performance check, 6-1
 Phase
 input-output, 10-4
 PHASE function, 10-4
 Phase inversion
 generator, 9-5
 testing for, 10-5
 Phase jitter measurements
 settling for, 12-3
 Phase meter hardware, 32-1
 Phase plots during sweeps, 11-3
 Phase range
 fixed, 11-3
 Phase test for CD player, 31-3
 Phono equalization, 23-1, 23-3
 Phototypesetter compatibility, 15-20
 Pink noise generation hardware, 32-5
 Pink noise mode, 20-6
 Pink vs white noise, 20-5
 Pixel mapping, screen to printer, 15-4
 Playback-only tape machine
 testing, 31-5
 testing in stereo, 11-13
 PLOT, 15-7
 illustration, 15-12
 memory requirements, 15-7
 menu, 15-8
 position of graph, 15-9
 Plot execution, 15-12
 Plotter
 size control of graph, 15-9
 Plotter in a Cartridge, 15-7
 Plotter output, 15-6
 Plotter pen selection, 15-10
 Plotting
 data onto stored image, 11-18
 dc voltage, 11-7
 digital input, 11-7
 generator amplitude, 11-7
 later, 15-13
 one variable with two sensitivities, 11-10
 resistance, 11-7

- two measured variables against one another, 11-16
 - vs. measured parameters, 11-16
- Points vs bytes, data editor, 28-7
- Polarity testing, 10-5
- Polarity units, 8-6
- Port A,B,C, 21-7
- Portrait mode
 - dot matrix, 15-6
- Portrait vs landscape
 - dot matrix printer, 15-5
- Position of graph
 - POST.EXE, 15-17
- Position, graph
 - PLOT.EXE, 15-9
- POST, 15-16
 - Illustration, 15-19
 - memory requirements, 15-17
 - menu, 15-17
- POST-EQ field, 9-2, 23-1
- Postscript files
 - Encapsulated, for import to Ventura, 15-20
- PostScript laser printer, 15-16
 - line style vs data, 15-19
- Power
 - at constant distortion, 26-1
 - constant, 8-2
 - in intermodulation measurements, 16-4
 - units, 8-4
- Power amplifier
 - generator, 32-4
- Power bandwidth measurements, 26-1, 31-9
- Power dissipation
 - input termination resistors, 10-8
- Power measurement, 10-9
 - dBm, 8-2
- Power tests
 - constant, 31-9
- PPM unit, 8-4
- Pre- vs de-emphasis, 23-4
- Pre-emphasis, 23-1, 23-3, 31-3
- Prefixes
 - numeric, 6-4, 9-2
- Preserving values from test to test, 25-10
- Principal voltmeter, 10-2
- Print format over-ride, 15-3
- Print size vs quality, 15-4
- Print speed vs quality, 15-4
- Printer mode table, 15-4
- Printer options at start-up using environment, 28-11
- Printer port as output port, 25-14
- Printing
 - bargraphs, 14-5, 15-6
 - comments under high-resolution graphs, 15-15
 - error file upon failure, 13-17
 - errors at test conclusion, 13-16
 - in a procedure to HPGL plotter or HP LaserJet, 15-13
 - in a procedure to PostScript laser printers, 15-20
 - the panels, 15-6
- Printing upon error, 25-7
- Printout
 - size control, 15-4
 - tabular, 15-6
- Procedure
 - halt until external event, 13-19
 - termination of external sweep during, 11-20
- Procedure Buffer Empty or Invalid error message, 25-1
- Procedure program flow control, 25-5
- Procedures
 - appending to bottom of existing procedure in Util Learn mode, 25-2
 - branching, 25-6
 - example, 25-2
 - failure to run, 25-1
 - filling in a form, 25-13
 - generation, 25-2
 - header, 25-1
 - keystrokes on panel, 25-2
 - keystrokes on panel during, 25-9
 - learning keystrokes, 25-2
 - listing with comments, 25-5
 - loading, 25-1
 - looping upon error, 25-8
 - printing upon error, 25-7
- Processed signal output connector , 32-3
- Programming System One via LIB-C or LIB-BASIC, 5-1
- Prompt message
 - failure to display due to semi-colon, 25-5
 - on bargraphs, 14-5
 - to operator, 13-19, 25-12
- Proof of performance
 - at constant modulation, 26-1
 - testing, 26-6, 31-2
 - tests, 22-1
- Protected fields, 13-6, 13-8, 25-10

PS/2 installation, 3-4
 PS/2 interface card, 3-1
 Pseudorandom noise, 20-5
 generation hardware, 32-5
 waveforms, 9-1
 Punched-out field, 25-10 - 25-11
 appearance, 28-9
 Push-to-set-0 dB reference, 8-3

Q

Quality vs size, printout, 15-4
 Quantization distortion, 31-10
 above theoretical floor, 8-3, 10-9
 Quit at carrier loss
 automatic, 22-12
 QUIT menu command, 13-3

R

Ram disk, 27-3
 Random noise, 20-5
 waveforms, 9-1
 Random noise generation hardware, 32-5
 Range
 analyzer, 10-9
 AUTO vs fixed, 10-11
 Range switching
 frequency, 32-4
 Range, dc voltage, 21-2
 RATE, digital input, 21-4
 Rate, DSP, 19-6
 Ratio unit, 8-4
 Ratio vs absolute units, 10-3
 RDAT THD+N vs frequency, 19-3
 Re-plotting graphs, 11-10
 Re-transmission
 attempts, 22-12
 data comm, 22-4
 READING meter range
 analyzer, 10-9
 READING Monitor Output, 32-3
 AUTO vs fixed range, 10-10
 READING RANGE
 how to fix, 10-11
 Reading rate, 10-6
 control of analyzer, 10-6
 dc voltage, 21-2
 switching during sweeps, 12-6
 vs accuracy, 10-6

 vs resolution, dc voltage, 21-2
 vs. frequency, 10-6
 Reading Voltmeter, 10-2
 Recommendation for number of steps, 11-4
 Recommended sweep settling parameters, 12-3
 Record head azimuth adjustments, 31-13
 Recording keystrokes, 13-19
 Recording test tapes, 31-5
 Reference
 phase, 10-4
 Reference tape testing, 31-5
 Regulation mode
 algorithms, 26-2
 concept, 26-1
 panel, 26-2
 sample test, 31-2, 31-9
 tolerance, 26-4
 Rejection filter, 10-3
 Relative dB, 8-3, 10-8
 Relative vs absolute distortion units, 8-4, 11-7
 Relay control, 21-7
 Remember the reference, 8-3
 Remote control
 operation, 13-4, 22-1 - 22-2
 operation, arming, 13-4
 system architecture, 22-1
 REMOTE files
 viewing and editing, 22-13
 REMOTE operation
 sequence of actions, 22-7 - 22-8
 REMOTE/LOCAL, 22-2
 Repeated sweeps, 11-11
 Repeating upon error, 25-8
 Reproduce head azimuth adjustments, 31-13
 Reset, 13-18
 of bargraph peak hold, 14-2
 Reset of external devices, 21-6
 Residual distortion
 spectrum analysis, 19-3
 Resistance measurement, 21-1 - 21-2
 low, 21-2
 Resistance plots, 11-7
 Resolution
 dc voltage, 21-2
 generator amplitude, 32-4
 graphic, 11-4
 increasing (dc voltmeter), 21-5
 limits, analog control of stimulus, 14-2
 RESOLUTION on sweep settling panel, 12-2

Restoring punched-out fields, 25-11
 Return from sub-procedure, 25-7
 Return key equivalent in procedure edit mode, 25-5
 Returning from sub-procedures, 13-5
 Returning from XDOS, 13-3
 Reverse termination
 generator, 32-4
 RIAA equalization, 23-1, 23-3
 RMS detector use, 10-6
 Roundoff in burst units, 20-1
 RS-232, 22-1
 cable for null modem, 22-5
 mouse, 29-1
 port number, 22-12
 port on PCI-2 card, 3-1, 29-1
 RS-232 version System One, 22-3
 Run
 Call, 25-6
 Call menu command, 13-4
 Exit, 25-6
 Exit menu command, 13-5
 Graph menu command, 13-4
 Local, 22-13
 Local menu command, 13-4
 menu commands, 13-4
 Procedure menu command, 13-4
 Remote, 22-13
 Remote menu command, 13-4
 Slave menu command, 13-4
 Slave, automatic, 22-12
 Test menu command, 13-4
 Run-up time testing, 21-7
 Running sweep tests, 11-9

S

S version System One, 22-3
 S-Pk detector, 10-6, 16-4
 S1 /F, 28-10
 S1 /L, 28-4
 S1.EXE, 5-1
 Sample rate
 digital input, 21-4
 for noise measurements, 12-6
 in external sweeps, 12-6
 Sample rates, DSP, 19-6
 Sample times, 11-5
 Samples for averaging, 12-3
 Satellite link tests, 12-4

Saturated output level, 26-4
 Save
 commands, common features, 13-6
 Comment menu command, 13-7
 Data menu command, 13-7
 EQ menu command, 13-8
 Graphic menu command, 13-8
 Graphics, 15-6
 Limit menu command, 13-7
 Macro menu command, 13-7
 menu commands, 13-6
 Overlay menu command, 13-8
 Procedure menu command, 13-7
 Sweep menu command, 13-7
 Test menu command, 13-7
 Waveform menu command, 13-8
 Saved Image Not Compatible With Graphics Mode, 11-18
 Saving configurations
 PostScript laser printer, 15-19
 Saving data
 during procedures, 25-15
 from virtual disks, 27-3
 Scaling
 dc measurements, 21-2
 dc voltage measurements, 21-2
 resistance measurements, 21-2
 Scanning switchers, 18-9
 Scientific notation, 6-4
 Scrape flutter, 17-1
 detector type, 17-2
 secB unit, 20-1 - 20-2
 Second harmonic distortion, 10-7
 SELECT.PRO, 6-1
 Selecting measurements for display, 11-6
 Selection via mouse, 29-2
 Selective frequency measurement, 10-4, 32-1
 Selective voltmeter, 10-3
 Semi-colon
 use of in procedures, 25-5
 Sensitivity of stimulus control in bargraph mode, 14-3
 Separation reference, 10-8
 Separations, color
 HP LaserJet, 15-13
 HPGL plotter, 15-13
 PostScript plotter, 15-19
 Sequence of generator configuration changes, 9-8
 Serial mouse, 29-1

- via PCI-2 card, 3-2
 - with PCI-1 card, 29-1
- Serial number storage of data, 25-16
- Serial port, 29-1
 - enable, PCI-2 card, 3-2
 - number, 22-11 - 22-12
- Service bureau
 - compatible output, 15-20
- Set-up, plotter-laser printer
 - saving, 15-12
- Setting dBr reference, 8-3
- Setting frequency reference, 8-4
- Settling
 - delay, 12-4
 - delay, minimum, 12-5
 - during time sweeps, 11-6
 - in dBr REF setting, 10-9
 - parameters for system flatness calibration, 23-5
 - time, 12-1
- Settling Delay , 12-4
- SETTLING DELAY in EXTERNAL level sweeps, 31-11
- Settling delay output, 21-6
- Settling on sweep settling panel, 12-2
- Settling time
 - frequency, 9-4
- Setup panel printout, 15-6
- Shift F9, 11-20
- Short slot compatibility, 3-3
- Short-distance remote operation, 22-5
- Signal processor testing, 11-17
- Signal to noise ratio
 - concepts, 31-6
 - measurements, 8-3
 - reference, 10-8
 - test, 31-6
- Simplifying system start-up, 28-1
- Simultaneous display of two channels, 10-3, 11-15
- Simultaneous record-playback flutter, 17-4
- Sine burst
 - amplitude, 9-7
 - units, 8-6
- Sine gated mode, 20-4
- Sine trigger
 - mode, 20-3
 - polarity, 20-3
- Sinewave burst hardware, 32-4
- Single diskette computers, 5-6
- Single point measurement, 11-2 - 11-3
- Single-value limits, 24-1
- Size
 - file, 13-7
 - graph from PostScript laser printer, 15-17
 - high-resolution graphs, 15-9
- Size field, digital generator, 19-7
- Size vs quality, printout, 15-4
- Size, graph printout, 15-4
- Smoothing data, 13-22
- SMPTE
 - IMD amplitude ratios, 16-1
 - IMD concepts, 31-7
 - IMD low tone selection, 9-4
 - IMD testing, 16-1
- SMPTE IMD architecture, 32-3
- Socket #1 gain selection, 10-7
- Software, 5-1
 - compatibility, 5-7
- SOL testing, 26-1, 26-4
- Source-2, 11-11
- Spacing between steps in external sweeps, 12-6
- SPDIF digital audio format, 19-3, 19-7
- Specific frequency steps, 11-4
- Spectral noise distribution
 - multi-track recorder, 18-15
 - residual noise, 30-1
- Spectrum analysis, 11-2
 - of SMPTE IMD, 32-3
- Speed
 - and FASTEST, 27-4
 - in EQSINE mode, 27-2
 - of testing, 27-1
 - per step, 27-1
 - remote operation, 22-11
 - sweep, 12-6, 27-2
 - tabular printout in procedures, 15-6
 - vs autorange, 10-10
 - with equalization, 23-2
 - with limits testing, 24-3, 27-2
- Split site systems
 - cabling required, 4-1
- Split-site
 - operation, 22-1
 - sequence of actions, 22-7 - 22-8
- Spot measurement, 11-3
- Squarewave, 9-1
 - amplitude calibration, 20-5
 - generation hardware, 32-5
 - mode, 20-5

- Standardized start-up conditions, 28-3
- Standardizing data files, 13-20
- Start-up control using environment, 28-11
- Starting
 - external device during time sweep, 21-7
 - System One, 5-6
 - with a procedure running, 28-4
 - with a test loaded, 28-4
 - with last test used, 13-3, 28-4
- Status bytes, AES-EBU, 19-7
- STD.TST file, 28-3
- Step number recommendations, 11-4
- Step size, 11-3
- Steps
 - maximum number of, 11-3, 11-10
- Stereo
 - bargraphs, 14-2
 - channel exchange, 11-12
 - external sweeps, 11-13, 11-20
 - multiplex testing, 9-5
 - preamp switching example, 18-11
- Stereo mode, 11-11 - 11-12
 - data display, 11-12
- Stereo tests
 - BPBR filter-based, 11-12
 - generator-based, 11-12
 - with switcher scans, 11-12
- Stereo units selection, 11-12
- Stop bits, 22-11
- Stop procedure, 25-12
- Stopping external frequency sweeps in procedure, 11-20
- Stored image
 - vs memory size, 28-6
- Storing DSP waveforms to disk, 13-8
- Strobe, digital input, 21-4
- Style
 - lines on plotter-laser printer graph, 15-10
 - lines on PostScript laser printer, 15-18
- Sub procedures
 - nesting, 25-7
- Sub-procedures, 13-4, 25-6
- Subdirectories
 - storing data in, 25-16
- Subtracting data files, 13-24
- Subtracting files, 13-17
- Successive sweeps in stereo mode , 11-12
- Summary error files, 24-4
- SWEEP (F9) DEFINITIONS PANEL, 11-1
- Sweep file
 - control of size loaded into memory, 28-7
- Sweep gate output, 21-7
- SWEEP SETTling, 12-1
 - auto/fixe response, 12-6
 - DELAY, 12-4
 - graphic explanation, 12-3
 - panel, 12-2
 - panel reproduction, 12-2
 - parameters recommended, 12-3
 - TIMEOUT, 12-4
- Sweep table files
 - attaching, 13-15
 - creation of, 11-4
 - disconnecting, 13-17
 - monotonicity requirement, 11-5
- Sweep trigger, 21-7
- Sweep without erasing old data, 11-10
- Sweep-erase-repeat
 - mode not functional, 11-11
 - vs memory size, 28-6
- Sweeping switchers, 18-9
- Sweeps
 - direction in external sweep, 11-3
 - display of distortion units, 11-7
 - DISPLAY selection, 11-7
 - gated, 23-2
 - limit to number of steps, 11-3
 - measurement parameter selection, 11-6
 - multiple, 11-10
 - nesting, 11-16
 - number of steps, 11-3
 - shape, 11-3
 - speed, 11-3
 - start and stop points, 11-3
 - step limitations, nested sweep, 11-17
 - step size, 11-3
 - table-based, 11-4
 - table-based, setup of, 11-5
 - useful graphic limit in number of steps, 11-4
 - vertical axis control, 11-7
 - with external signals, 11-2
- Swept dc output, 21-3
- Swept digital output, 21-5
- Swept intermod tests, 16-4
- Swept measurement plotting conventions, 11-6
- Swept signal measurement, 11-19
- Switcher
 - ac voltage setting, 4-1

- address limitations, 18-7
- addressing, 18-7
- channel selection, 18-8
- commonalities, 18-1
- complement mode, 18-8
- control panel, 18-8
- input, 18-1
- maximum channel number, 18-1
- offset, 18-8
- output, 18-1
- patch point, 18-2
- SYNC output, 32-5
- Synch signals available, 32-5
- Synchronizing
 - signal outputs, 21-6
 - start of signal to time sweep, 21-7
 - triggered bursts with measurements, 21-6
 - with pseudorandom noise, 12-6
- SYS-20 and SYS-02 units
 - cabling required, 4-1
- SYS-200 series, 19-1, 19-3
- SYS-300 series, 19-1, 19-3
- SYS22CK.PRO, 6-1
- System flatness
 - improving, 23-5
- System interaction problems due to mouse, 3-2
- System One software, 5-1
- System reset, 13-18

T

- T
 - in graphs, 12-4
 - timeout flag, 12-4
- Table
 - sweep, 11-4
- TABLE printout, 15-6
- Tabular display, 11-9
- Tabular printout, 15-1, 15-6
- Tape head azimuth adjustments, 31-13
- Tape MOL testing
 - at multiple frequencies, 11-17
- Tape player testing, 31-5
- Tape recorder
 - azimuth adjustments, 11-3
 - distortion testing, 31-9
 - response testing, 31-4
 - simultaneous record-playback tests, 12-4
 - testing, 12-5, 31-4, 31-9
- Tape speed error, 8-5

- Target for bargraph adjustment, 14-2
- Temporary file
 - PLOT.EXE, 15-8
 - POST.EXE, 15-17
- Terminal strip switcher, 18-5
 - connections, 18-5
 - jumper locations, 18-5
- Terminating keystroke recording, 13-19
- Terminating procedure upon failure, 13-17
- Termination, input, 10-8
- Test data management, 25-15
- Test examples, 6-1
- Test loading speed, 27-4
- Test time reduction via FASTEST, 27-4
- Test without erasing old data, 11-10
- Testing regulation setup panels, 26-5
- Testing with analog sweeps, 12-7
- Testing with limits, 24-3
- Text editor, 13-11, 13-14
- Text fonts
 - POST.EXE, 15-19
- Text printout below graph, 15-3
- THD vs THD+N, 31-7
- THD+N architecture, 32-3
- THD+N mode, 10-3
- THD+N readings in dBr units, 10-9
- Third bargraph, 14-3
- Third harmonic distortion, 10-7
- Third octave filter, analyzer, 10-3
- Third-octave frequency steps, 9-4
- Three head tape recorder response testing, 31-4
- Tic mark control, 11-2
- Tic marks, vertical, 11-7
- TIM
 - IMD concepts, 31-8
 - intermod theory, 16-1
- Time between burst, 20-2
- Time chart of wow and flutter, 17-5
- Time delay
 - determining, 12-5
 - in procedures, 13-19, 25-13
 - unit tests, 12-4
 - when F4 pressed, 10-9
- Time measurement sampling intervals, 11-5
- Time required to range, 10-10
- Time sweep, starting external device during, 21-7
- Time sweeps, settling, 11-6
- Time-based measurements, 11-1
- Timeout, 12-4

- data comm, 22-4, 22-12
- flag in data, 12-4
- flag printout, 15-6
- for 300 baud, 22-4
- TOLERANCE on sweep settling panel, 12-2
- Tone burst, 9-1
 - amplitude, 9-7, 20-3
 - amplitude resolution, 20-3
 - control panel, 9-7
 - frequency, 20-1
 - interval, 20-2
 - sweeps, 11-1
 - switching phase, 20-1
 - units, 8-6
- Total harmonic distortion vs total harmonic distortion plus noise, 31-7
- Transfer between buffers, 13-11
- Transformer output
 - generator, 32-4
- Transient
 - at Monitor Output connectors, 10-10
- Transposition of cables
 - testing for, 10-5
- Trigger
 - output, 21-6
 - polarity, 20-3
- Trigger delay output, 21-6
- Triggered burst, 20-1
 - amplitude, 20-3
- Triggered sine mode, 20-3
- Twin-tone intermod theory, 16-1
- Two's complement format
 - digital input, 21-4
 - digital output, 21-5
- Two-character codes, 25-10
- Two-dimensional mouse, 14-3
- Two-head tape recorder
 - distortion tests, 31-10
 - testing, 31-5
- Two-wire Ohms, 21-2
- Type faces
 - POST.EXE, 15-19
- Type font selection
 - PostScript laser printer, 15-19
- Typesetter compatibility, 15-20
- Typing in filenames during procedure generation, 25-2

U

- Unbalanced cables, 9-6, 10-8
- Unbalanced output, 9-6
- Units
 - AMPSTEP, 9-2
 - user-assigned, 13-16
- Units of measure
 - intermod testing, 16-2
- Unmanned station testing, 22-1
- UNREGULATED flag printout , 15-6
- Unregulated readings, 26-4
- Upper limits, attaching, 13-15
- USASI noise, 20-6
- User prompts on bargraphs, 14-5
- User-assigned units, 13-16
- User-selected default conditions, 28-3
- User-written programs, 5-1
- Using the mouse, 29-2
- Util
 - Break menu command, 13-19
 - Delay menu command, 13-19
 - End menu command, 13-19
 - Feed, 15-4
 - Goto, 25-6
 - Goto menu command, 13-19
 - Invert, 13-20
 - Learn, 25-2
 - Learn menu command, 13-19
 - Message menu command, 13-19
 - Normalize, 13-20
 - Out menu command, 13-18
 - Out to ports A,B,C, 21-8
 - Prompt menu command, 13-19
 - Restore menu command, 13-18
 - SERIAL-DSP menu command, 13-20
 - Wait menu command, 13-19
- Utility menu commands, 13-18

V

- V command line option, 25-12
- VCA testing, 21-3
- VDISK.SYS, 27-3
- Ventura Publisher
 - PLOT.EXE, 15-12
 - POST.EXE, 15-20
- Version 1.60 software
 - mouse compatibility, 3-2
- Vertical division marks, 11-7

Video appearance of punched-out fields, 28-9
 Video attributes, 25-11
 Virtual disk, 27-3
 Voice announcements on reference tapes, 11-20, 31-5
 Voltage ratio unit, 8-4
 Voltage-controlled amplifier testing, 21-3
 Voltmeter-input channel relationship, 32-1
 Volts p-p, 8-1
 Volts rms, 8-1

W

Warm boot, 28-2
 Watts, 8-4
 Watts reference, 10-9
 Wave analyzer, 10-3
 Waveform display
 burst, via DSP, 19-3
 Waveform selection, 9-1
 Weighting filter
 wow and flutter, 17-1
 White noise
 bandwidth, 20-5
 mode, 20-5
 White noise generation hardware, 32-5
 White vs pink noise, 20-5
 Wide lines
 plotter-laser printer, 15-11
 Wideband flutter, 17-1
 Worst-case crosstalk, 18-16
 Wow and flutter
 2 sigma, 17-6
 bandwidth, 17-2
 displays, 17-5
 modes, 10-3
 test frequencies, 17-2
 theory, 17-1
 Wow and flutter architecture, 32-3
 Writing messages into error files, 13-19
 Writing to output port during procedures, 21-8

X

X-Y plots, 11-16
 X/Y unit, 8-4, 20-3
 XDOS
 menu command, 13-3
 returning from, 13-3
 Xerox Ventura Publisher

PLOT.EXE, 15-12
 POST.EXE, 15-20
 XLR hot pin, 9-6